

www.glasstoolseshop.com
www.anhuaglasstools.com



ANHUA 广州安华磨具
专注研磨抛光



广州安华磨具有限公司

地址: 广州市黄埔区黄埔大道东保利鱼珠港S4栋509

电话: 0086-20-82162591 82161536

传真: 0086-20-82160381

E-mail: info@anhuaglasstools.com

Http://www.glasstoolseshop.com

Http://www.anhuaglasstools.com

淘 宝: 广州安华玻璃磨具耗材工具店

旺旺号: 安华磨具2010

Addr.: suite 501, Bldg. D8, Linghui Chuangzhan Commercial
Centre, Yingcai St., Huicai Rd., dongpu, Tianhe District
Guangzhou, China

Tel.: 0086-20-82162591 82161536

Fax: 0086-20-82160381

E-mail: info@anhuaglasstools.com

Skype: anhua_glasstools

Http://www.glasstoolseshop.com

Http://www.anhuaglasstools.com

所有产品颜色及尺寸仅供参考, 以产品实样为准, 广州安华公司保留最终解释权, 模仿必究。
All sizes and colours of these products are just for reference, please subject to
actual products. All right of expansion reserved, any copying without Anhua
company's written permission is definitely prohibited.

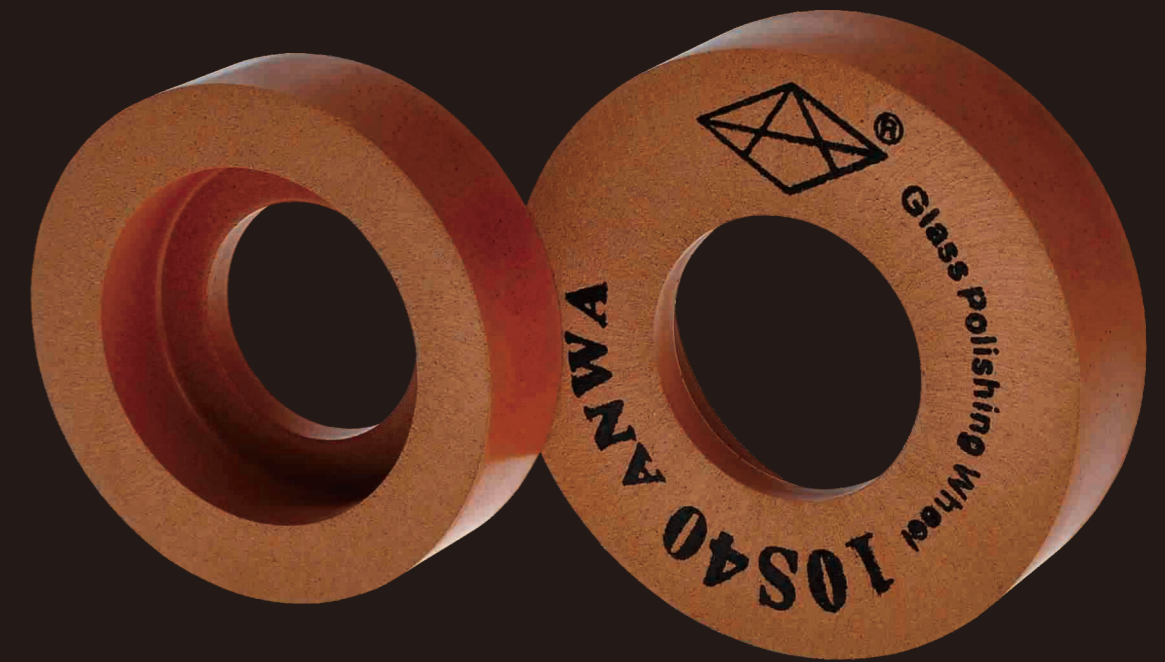

Anhua provides you a powerful technical
support for glass processing
High quality glass tools

广州安华磨具
专注研磨抛光



11

ANHUA

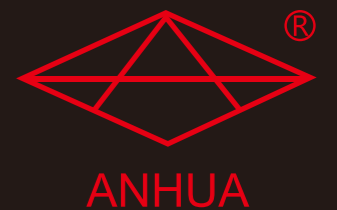



Factory



广州安华磨具创立于1990年，历经27载，已成为行业中集产品设计、研发、生产、销售、物流配送及售后服务为一体的综合型领导企业。通过ISO9001:2000德国MPA质量认证。

工厂直销，拥有先进的生产设备，和创新的研发团队，为你量身定制专属的VIP产品。

意大利著名品牌RBM、LOXEAL等中国区代理，保证100%原装进口直销。

汽车玻璃、家电玻璃金刚石磨轮领域中，我司不断钻研创新，取得了飞跃性的突破与发展。

行业首创，微信商城下单系统，种类齐全、操作简单便捷，倡导“购物零风险”理念，品种涵盖玻璃深加工企业中的所有耗材，全力打造玻璃耗材自选、自购的“一站式”商城平台。

“品质保证、客户受益”是安华的一贯宗旨，对客户负责，对产品负责是安华一贯的服务态度，欢迎海内外朋友与安华开展友好合作，共创美好未来。

We are manufacturer of Glass Grinding and Polishing Wheels and Tools for glass deep processing for 27 years, not only the manufacturer and supplier but also the solution provider.

With Advanced Automatic Production Equipment and Innovative Research and Development Team, keeping stable quality continuity and sustainability is the principle and concept to ensure customers lowest-cost but high efficient production.

In the fields of Vehicle Glass and Appliance Glass, our profile diamond wheels have their well reputation on on Price Performance Ratio.

As per Rubber products for Glass Machine Accessories and Simple Glass Hand Tools, we set up dedicated production line.

Regarding international cooperation, we are the authorized Chinese dealer and distributor of RBM ITALIA and LOXEAL etc. 100% original guarantee.

The purpose of our above investments is to make quality control as the responsibility and service to customers and have them one-stop purchase.

We are sure that you will be of well service with our full experience in the glass field.



GLASS TOOLS



P2-10
金刚石磨轮系列
DIAMOND GRINDING WHEEL SERIES
双边机金刚轮 / 直边机金刚轮 / 斜边机金刚轮 / 异形机金刚轮 / 其他



P30-33
进口抛光轮系列
IMPORTED POLISHING WHEELS
进口10S、9R抛光轮 / 进口BK、AO抛光轮 / 进口精抛轮



P11-13
四边磨磨轮系列
DIAMOND WHEELS & RESIN WHEELS FOR FOUR SIDES EDGER
四边磨金刚轮 / 四边磨树脂轮



P34
Low-E玻璃除膜轮系列
LOW-E GLASS COATING DELETION WHEEL SERIES
干除膜轮 / 湿除膜轮 / 特殊规格除膜轮



P14-15
岩板专用磨轮系列
GRINDING WHEELS FOR SINTERED STONE PROCESSING
CNC / 异形机 / 异形斜边机 / 直双边机



P35-40
玻璃钻铣系列
MILLING TOOLS/DRILL BITS SERIES
免磨钻头、倒角器 / 烧结钻头、倒角器 / 整体钻头、CNC磨头 / 水嘴、接头



P16-19
树脂轮系列
RESIN WHEEL SERIES
双边机树脂轮 / 直边机树脂轮 / 斜边机树脂轮 / 异形斜边树脂轮



P41-47
机械配件系列
MACHINE FITTING SERIES
铝托盘、铝托座、同步带 / 其他配件 / 压板、链条 / 防水套 / 水泵、电机



P20-29
抛光轮系列
POLISHING WHEEL SERIES
10S抛光轮 / CE-3、X-5000精抛轮 / BK抛光轮 / BD抛光轮 / 羊毛轮 / 石头轮



48-49
氧化铈抛光系列
CERIUM OXIDE
氧化铈抛光粉



全齿金刚轮 Segmented Diamond Wheel



■ 用于直边机、双边机的磨削
规格 Technical Specification Size:(mm)

编号 Code	外径 D	孔径 H	工作层尺寸 Actual Work Rim Size	粒度 G
A1-1	150	12,22,25,50	15 × 10	80,100,120,140
	175	12,50	15 × 10	80,100,120,140

Application: It is used for edging machine and for double edging machine as position 1. Best Choice for Laminated Glass Processing.

密齿金刚轮 With dense teeth Diamond Wheel



■ 用于高速双边机的磨削
规格 Technical Specification Size:(mm)

编号 Code	外径 D	孔径 H	工作层尺寸 Actual Work Rim Size	粒度 G
A1-2	150	12,22,50	15 × 10	100,120,140
	175	12,22,50	15 × 10	100,120,140

Application: Feeding Speed.(8M/min~18M/min)on High Speed Duouble Edger.

外半齿金刚轮 Outer Segmental Diamond Wheel



■ 用于直边机、双边机的磨削
规格 Technical Specification Size:(mm)

编号 Code	外径 D	孔径 H	工作层尺寸 Actual Work Rim Size	粒度 G
A1-3	150	12,22,25,50	13 × 10	100,140,180
	175	12,50	13 × 10	100,140,180

Application: 1.) It is used as position 2 for straight-line edger and double edger;
2.) Special for laminated glass as position 1 & position 2.

杯形金刚轮 Diamond Cup Wheel



■ 用于直边机、双边机的磨削
规格 Technical Specification Size:(mm)

编号 Code	外径 D	孔径 H	工作层尺寸 Actual Work Rim Size	粒度 G
A1-4	175	12,50	8 × 10	100,140,180,240
	150	12,22,25,50	8 × 10	100,140,180,240
	130	12,22,50	8 × 10	240,320
	100	12,22,50	8 × 10	240,320

Application: It is used for edging machine and double edging machine.

注: 特殊尺寸可按要求订做。Remarks: Different specifications are available if request.



金刚石磨轮系列

DIAMOND GRINDING WHEEL SERIES

- 双边机金刚轮
- 直边机金刚轮
- 其他
- 斜边机金刚轮
- 异形机金刚轮

1
金刚石磨轮系列

1
金刚石磨轮系列

外齿金刚轮 Outer Segmented Diamond Wheel for beveling machine



■ 用于斜边机的磨削

规格 Technical Specification Size:(mm)

编号 Code	外径 D	孔径 H	工作层尺寸 Actual Work Rim Size	粒度 G
A2-1	150	12,22	7 x 12	80,100,120,140

Application: It is used for beveling machine.

斜边机金刚轮 Diamond Wheel for Beveling Machine



■ 用于斜边机的磨削

规格 Technical Specification Size:(mm)

编号 Code	外径 D	孔径 H	工作层尺寸 Actual Work Rim Size	粒度 G
A2-2	150	12,22,25,50	5 x 10	80,100,140,180

Application: It is used for beveling machine & for SB-10 shape beveling machine.

圆边/直边金刚轮 Standard Diamond Profile Wheel PE / FA



■ 用于直线圆/直边及异形机圆/直边的磨削

规格 Technical Specification Size:(mm)

编号 Code	外径 D	孔径 H	玻璃厚度 G.T	粒度 G
A3-1	80,100,150,175,200	22	2,3,4,5,6,8,10,12,15,19,25	80,150,180,240

Application: It is used for pencil edge / flat with arris on shape machine.

圆边金刚轮 Diamond Profile Wheel for Schiatti Round Edger



■ 用于意大利Schiatti机圆边的磨削。

规格 Technical Specification Size:(mm)

编号 Code	外径 D	孔径 H	玻璃厚度 G.T	粒度 G
A3-2	175	25	3,4,5,6,8,10	80,150,180,240

Application: It is used for pencil edge on Schiatti Round Edger, keyway size 4 x 8mm

玻璃效果图

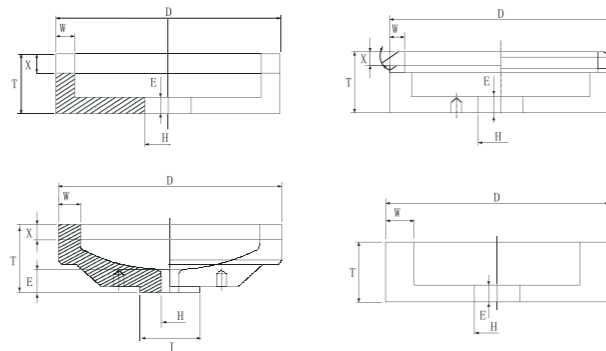
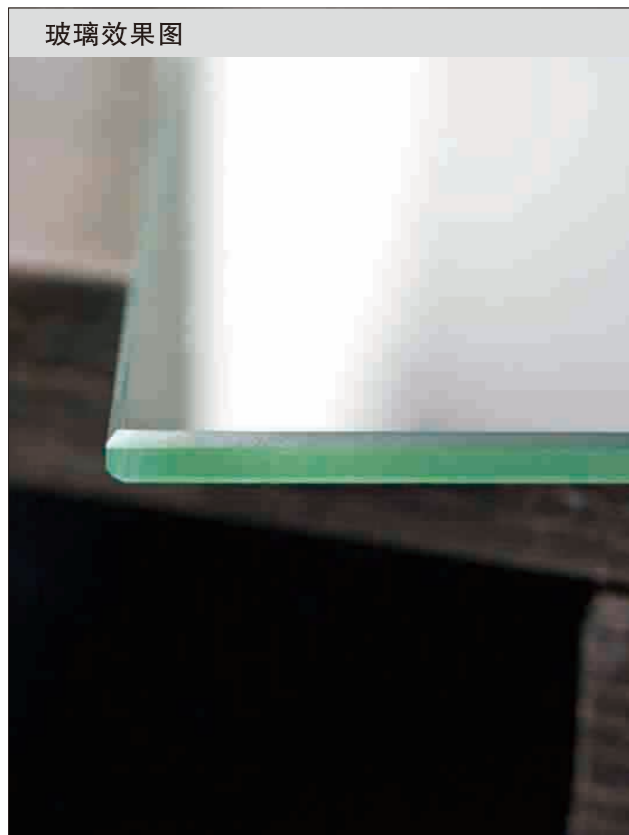

磨轮参数定义

D 磨轮外径	D Wheel diameter
E 磨轮内孔处厚度	E Hub thickness at the bore
H 磨轮内孔	H Bore diameter
J 底座台阶直径	J Hub diameter
T 磨轮总高	T Total wheel height
V 斜边角度	V Bevel angle
W 边部	W Diamond section width
X 金刚石断面厚度	X Diamond section depth

注：特殊尺寸可按要求订做。Remarks:Different specifications are available if request.

Q6 优质圆边/直边金刚轮 Upgraded Diamond Profile Wheel PE / FA



■ 用于直线圆/直边及异形机圆直边的磨削。

规格 Technical Specification Size:(mm)

编号 Code	外径 D	孔径 H	玻璃厚度 G.T	粒度 G
A3-3	150,175,200	22	2,3,4,5,6,8,10,12,15,19	80,150,180,240

Application: Adopt imported raw material making wheels sharper and more wear-resistant,used for pencil edge / flat with arris on Shape Machine.

Q6 优质圆边/直边金刚轮 Upgraded Diamond Profile Wheel PE / FA



■ 用于直线圆/直边及异形机圆直边的磨削。

规格 Technical Specification Size:(mm)

编号 Code	外径 D	孔径 H	玻璃厚度 G.T	粒度 G
A3-4	80,100	22	2,3,4,5,6,8,10,12,15,19	80,150,180,240

Application: Adopt imported raw material making wheels sharper and more wear-resistant,used for pencil edge / flat with arris on Shape Machine.

注：特殊尺寸可按要求订做。Remarks:Different specifications are available if request.

圆边 / 直边金刚轮 Standard Diamond Profile Wheel PE / FA



■ 用于异形机圆/直边的磨削
规格 Technical Specification Size:(mm)

编号 Code	外径 D	孔径 H	玻璃厚度 G.T	粒度 G
A3-5	25	12	3,4,5,6,8,10,12, 15,19	80,150, 180,240
	35,50	22	3,4,5,6,8,10,12, 15,19	80,150, 180,240

Application: It is used for pencil edge / flat with arris.

直线圆边机金刚轮 Profile Diamond Wheel for Round Edge Machine



■ 用于直线圆边机的磨削
规格 Technical Specification Size:(mm)

编号 Code	外径 D	孔径 H	玻璃厚度 G.T	粒度 G
A4-1	175,200	60,90	3,2,3,8,4,5,6, 8,10	120,150,180,240

Application: 1.) Used on vertical/horizontal round glass edge machine
2.) Edge shape:PE/FA
3.) Fixing hole:90mm

45° 斜坡金刚轮 45° Miter Diamond Wheel



■ 用鸭嘴边金刚轮前，可以减少鸭嘴轮的损耗
规格 Technical Specification Size:(mm)

编号 Code	外径 D	孔径 H	玻璃厚度 G.T	粒度 G
A6-1	100,150	22	8,10,12,15,19	80,150,180,240

Application: It is used for shape edge before OG wheel and can reduce the waste of OG wheel.

单鸭嘴金刚轮 Standard OG Diamond Wheel



■ 用于单鸭嘴边的磨削
规格 Technical Specification Size:(mm)

编号 Code	外径 D	孔径 H	玻璃厚度 G.T	粒度 G
A6-2	100,150,175	22	8,10,12,15,19	80,240

Application: It is used for rough grinding of OG shape.

直线圆边机金刚轮 Profile Diamond Wheel for Round Edge Machine



■ 用于直线圆边机的磨削
规格 Technical Specification Size:(mm)

编号 Code	外径 D	孔径 H	玻璃厚度 G.T	粒度 G
A4-2	200	50	4,5,6,8,10	80,150,180,240

Application: 1.) Used on vertical/horizontal round glass edge machine
2.) Edge shape:PE, FA
3.) Fixing hole: 50mm

平行金刚轮 Standard Diamond Flat Edge Wheel (General Style)



■ 用于直线圆/直边及异形机的磨削
规格 Technical Specification Size:(mm)

编号 Code	外径 D	孔径 H	磨轮厚度 T	粒度 G
A5-1	100,150,175,200	22	10,15,20,25,30	80,150,180,240
A5-2	175,200	12	定做 customized	80,150,180,240

FE style, it is used for round edge machine and shape machine.

双鸭嘴金刚轮 Standard 2-OG Diamond Wheel



■ 用于双鸭嘴边的磨削
规格 Technical Specification Size:(mm)

编号 Code	外径 D	孔径 H	玻璃厚度 G.T	粒度 G
A6-3	100,150	22	8,10,12,15,19	80,240

Application: It is used for rough grinding of 2-OG shape.

三鸭嘴金刚轮 Standard 3-OG Diamond Wheel

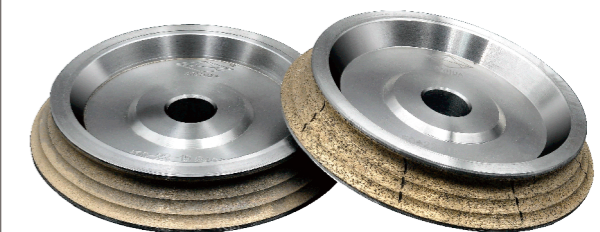

■ 用于三鸭嘴边的磨削
规格 Technical Specification Size:(mm)

编号 Code	外径 D	孔径 H	磨轮厚度 G.T	粒度 G
A6-4	100,150	22	10,12,15,19	80,240

Application: It is used for rough grinding of 3-OG shape.

注：特殊尺寸可按要求订做。Remarks: Different specifications are available if request.

注：特殊尺寸可按要求订做。Remarks: Different specifications are available if request.

长鸭嘴金刚轮 Standard Long OG Diamond Wheel



■ 用于长鸭嘴边的磨削
规格 Technical Specification Size:(mm)

编号 Code	外径 D	孔径 H	磨轮厚度 G.T	粒度 G
A6-5	100,150	22	8,10,12	80,240

Application: It is used for rough grinding of longer OG shape.

30° 长鸭嘴金刚轮 30° Long OG Diamond Wheel



■ 用于异形机
规格 Technical Specification Size:(mm)

编号 Code	外径 D	孔径 H	玻璃厚度 G.T	粒度 G
A6-6	100,150	22	8,10,12	80,150,180,240

Application: It is used for shape machine.

汽车玻璃金刚轮 (MR. VRP 槽形) Profile Diamond Wheel for Auto Glass (MR/VRP Groove)



■ 用于坂东预处理线(第一代)

规格 Technical Specification Size:(mm)

编号 Code	外径 D	孔径 H	玻璃厚度 T	粒度 G
A6-9	100,150	30	2.1,2.5,3.3,2,3.5,4.5,6	150,180,200,240

Application: Use on Bando preprocessing Line(1st Version)

汽车玻璃金刚轮 (MR. VRP 槽形) Profile Diamond Wheel for Auto Glass (MR/VRP Groove)



■ 用于百超.坂东机.佰荣森/佰荣臻预处理线

规格 Technical Specification Size:(mm)

编号 Code	外径 D	孔径 H	玻璃厚度 T	粒度 G
A6-10	100,150	63.5	2.1,2.5,3.3,2,3.5,4.5,6	150,180,200,240

Application: Used on Bystronic and Bandong and Byrongson Preprocessing Line

1/4 圆边金刚轮 Standard Waterfall Diamond Wheel (General Style)



■ 用于异形机

规格 Technical Specification Size:(mm)

编号 Code	外径 D	孔径 H	玻璃厚度 G.T	粒度 G
A6-7	100,150	22	8,10,12,15,19	80,150,180,240

Application: It is used for shape machine.

特殊1/4圆边金刚轮 Standard Special Waterfall Diamond Wheel



■ 用于异形机

规格 Technical Specification Size:(mm)

编号 Code	外径 D	孔径 H	玻璃厚度 G.T	粒度 G
A6-8	100,150	22	8,10,12,15,19	80,150,180,240

Application: It is used for shape machine.

周齿金刚轮 Segmented Diamond Profile Wheel(Flat Edge)



■ 用于 CNC 加工中心的粗磨

规格 Technical Specification Size:(mm)

编号 Code	外径 D	孔径 H	玻璃厚度 G.T	粒度 G
A7-1	100,150,200	22	4,6,8,10,12,15,19	80

Application: It is used for rough grinding on CNC Machine.

CNC 金刚轮 CNC Diamond Profile Wheel (With Water flows)



■ 用于 CNC 加工中心

规格 Technical Specification Size:(mm)

编号 Code	外径 D	孔径 H	玻璃厚度 G.T	粒度 G
A7-2	100,120,150	22	3,4,5,6,8,10,12,15,19	150,180,240

Application: CNC diamond wheel with inner cooling system, which is sharper, last for long and can work at a very high speed.

注: 特殊尺寸可按要求订做。Remarks:Different specifications are available if request.

注: 特殊尺寸可按要求订做。Remarks:Different specifications are available if request.

1

金刚石磨轮系列

CNC 金刚轮 CNC Diamond Profile Wheel (no water flows)



■ 用于国产 CNC 加工中心
规格 Technical Specification Size:(mm)

编号 Code	外径 D	孔径 H	玻璃厚度 G.T	粒度 G
A7-3	100,120,150	22	3, 4, 5, 6, 8, 10,12,15,19	150,180,240

Application: CNC diamond wheel no inner cooling system, which is Special for Chinese CNC Machine.

刻花金刚轮 Diamond V-Engraving Wheel(General Style)



■ 用于 刻花机

规格 Technical Specification Size:(mm)

编号 Code	外径 D	孔径 H	刻槽宽度 Groove Width	磨轮角度 V-angle	粒度 G
A7-4	150	22	6,8,10	V152	80,120,150,180,240

Application: It is used for CNC Engraving Machine.

精工金刚轮 Diamond Wheel for JINGGONG Seaming Machine



■ 用于四边磨边机的磨削

规格 Technical Specification Size:(mm)

编号 Code	外径 D	孔径 H	工作层尺寸 Actual work Rim Size	粒度 G
A9-1	160	32	6 x 18, 6 x 20	240

Application: It's used for automatic horizontal glass straight line Seaming Machine.

亿海四边磨金刚轮 Diamond Wheel for Suntech Seaming Machine



■ 用于四边磨边机的磨削

规格 Technical Specification Size:(mm)

编号 Code	外径 D	孔径 H	磨轮厚度 T	粒度 G
A9-2	150	10	22	320

Application: It's used for automatic horizontal glass straight line Seaming Machine.

2

四边磨磨轮系列

V 形槽金刚轮 Diamond V-groove Wheel for Chamfering



■ 用于玻璃边的磨削 (一个轮可磨三种厚度玻璃)

规格 Technical Specification Size:(mm)

编号 Code	外径 D	孔径 H	玻璃厚度 G.T	粒度 G
A8-1	150	22	3, 4, 5, 6,10,12,15	80,150,180,240

Application: It's use for chamfering to 4,5,6 mm glass on one wheel.

多线槽金刚轮 Standard Multi Grooves Diamond Profile Wheel PE / FA

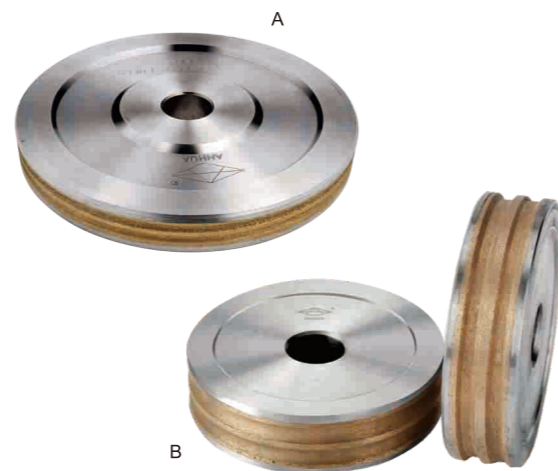

■ 用于直线圆 / 直边及异形机圆直边的磨削

规格 Technical Specification Size:(mm)

编号 Code	外径 D	孔径 H	玻璃厚度 G.T	粒度 G
A8-2	150	100,150,175,200	3, 4, 5, 6	80,150,180,240

Application: It is used for pencil edge / flat with arris.

高力威四边磨金刚轮 Diamond Wheel for Golive Seaming Machine



■ 用于四边磨边机的磨削

规格 Technical Specification Size:(mm)

编号 Code	外径 D	孔径 H	工作层厚度 Work Rim Width	粒度 G
A9-3	160	10/20	10	240, 320

Application: It's used for automatic horizontal glass straight line Seaming Machine.

特能四边磨金刚轮/树脂轮 Diamond Wheel / Resin Wheel for Tenon Seaming Machine



■ 用于四边磨边机的磨削

规格 Technical Specification Size:(mm)

编号 Code	外径 D	孔径 H	工作层宽度 Work Rim Width	粒度 G
A9-4	160	40	10 x 15	200

Application: It's used for automatic horizontal glass straight line Seaming Machine.

注：特殊尺寸可按要求订做。Remarks:Different specifications are available if request.

注：特殊尺寸可按要求订做。Remarks:Different specifications are available if request.

2

四边磨磨轮系列

精工邦通四边磨树脂轮 Resin Wheel for Jinggong Bangtong Seaming Machine



■ 用于四边磨边机的磨削

规格 Technical Specification Size:(mm)

编号 Code	外径 D	孔径 H	工作层尺寸 Actual Work Rim Size	粒度 G
A9-5	160	11/22	10 x 15	200

Application: For Jinggong Bangtong Seaming Machine.

新泓达四边磨金刚轮 Diamond Wheel for Xinhongda Seaming Machine



■ 用于四边磨边机的磨削

规格 Technical Specification Size:(mm)

编号 Code	外径 D	孔径 H	工作层尺寸 Actual Work Rim Size	粒度 G
A9-6	160	10	6 x 22	320

Application: For Xinhongda Seaming Machine.

欧玻四边磨金刚轮 Diamond Wheel for Oubo Seaming Machine



■ 用于四边磨边机的磨削

规格 Technical Specification Size:(mm)

编号 Code	外径 D	孔径 H	工作层尺寸 Actual Work Rim Size	粒度 G
A9-7	150	20	6 x 12	240,320

Application:for Oubo Seaming Machine.

亚龙四边磨轮 Diamond Wheel for Yalong Seaming Machine

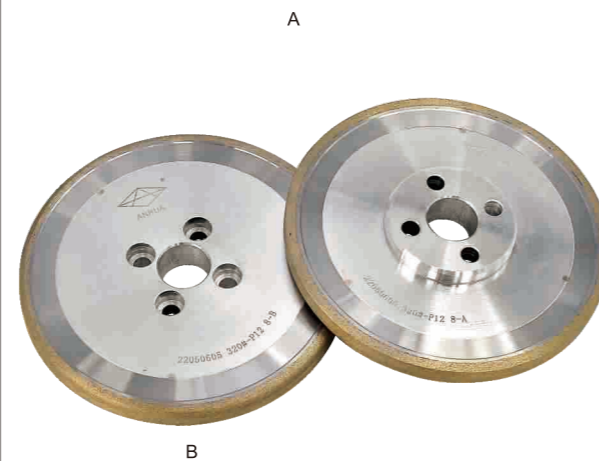

■ 用于四边磨边机的磨削

规格 Technical Specification Size:(mm)

编号 Code	外径 D	孔径 H	工作层尺寸 Actual Work Rim Size	粒度 G
A9-8	160	25	6 x 12	320

Application:Fo Yalong Seaming Machine.

锦泰宏威四边磨树脂轮 Resin Wheel for Jintaihongwei Seaming Machine



■ 用于四边磨边机的磨削

规格 Technical Specification Size:(mm)

编号 Code	外径 D	孔径 H	工作层尺寸 Actual Work Rim Size	粒度 G
A9-9	160	40	10 x 38	200

Application: Fo Jingtai Hongwei Seaming Machine

巨刚四边磨树脂轮 Resin Wheel for Jugang Seaming Machine



■ 用于四边磨边机的磨削

规格 Technical Specification Size:(mm)

编号 Code	外径 D	孔径 H	工作层尺寸 Actual Work Rim Size	粒度 G
A9-10	160	12	10 x 30	200

Application: It's used for automatic horizontal glass Seaming Machine.

特能四边磨树脂轮 Resin Wheel for Tenon Seaming Machine



■ 用于四边磨边机的磨削

规格 Technical Specification Size:(mm)

编号 Code	外径 D	孔径 H	工作层尺寸 Actual Work Rim Size	粒度 G
A9-11	160	68	10 x 38	200

Application: For Tenon Seaming Machine

精工四边磨树脂轮 Resin Wheel for Jinggong Seaming Machine



■ 用于四边磨边机的磨削

规格 Technical Specification Size:(mm)

编号 Code	外径 D	孔径 H	工作层尺寸 Actual Work Rim Size	粒度 G
A9-12	160	32	10 x 20,10 x 18	200

Application: It's used for automatic horizontal glass straight line Seaming Machine.

凯业金刚轮 Diamond Wheel for Kaiye Seaming Machine



■ 用于四边磨边机的磨削

规格 Technical Specification Size:(mm)

编号 Code	外径 D	孔径 H	工作层尺寸 Actual Work Rim Size	粒度 G
A9-13	160	22	10 x 35	200

Application: It's used for automatic horizontal Seaming Machine

尚玻金刚轮 Diamond Wheel for Shangbo Seaming Machine



■ 用于四边磨边机的磨削

规格 Technical Specification Size:(mm)

编号 Code	外径 D	孔径 H	工作层尺寸 Actual Work Rim Size	粒度 G
A9-14	160	35	10 x 40	200

Application: It's used for automatic horizontal glass Seaming Machine.

注：特殊尺寸可按要求订做。Remarks:Different specifications are available if request.

注：特殊尺寸可按要求订做。Remarks:Different specifications are available if request.

2

四边磨磨轮系列

3
岩板磨轮系列

3
岩板磨轮系列

岩板精抛光轮 Fine Polishing Wheel for Sintered Stone

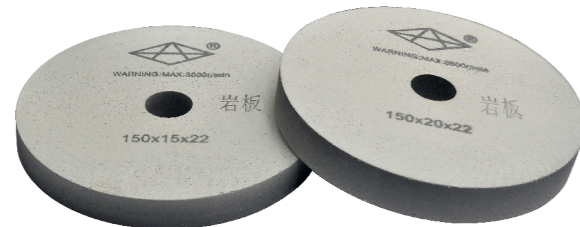

■ 用于岩板CNC/异形机的磨削

规格 Technical Specification Size:(mm)

编号 Code	外径 D	孔径 H	磨轮厚度 T
A10-1	150	22	15,20,25,30

Application: It's used for sintered stone on CNC working center or Shape Machine.

岩板抛光轮 Rough Polishing Wheel for Sintered Stone



■ 用于岩板CNC/异形机的磨削

规格 Technical Specification Size:(mm)

编号 Code	外径 D	孔径 H	磨轮厚度 T
A10-2	150	22	15,20,25,30

Application: It's used for sintered stone on CNC working center or Shape Machine.

岩板全齿1# Full Seginents Diamond Wheel #1 for Sintered Stone



■ 用于岩板直/双边机的磨削

规格 Technical Specification Size:(mm)

编号 Code	外径 D	孔径 H	工作层尺寸 Actual Work Rim Size
A10-5	150	22	15 x 10

Application: It's used for sintered stone on Double Edger.

岩板全齿2# Full Seginents Diamond Wheel #2 for Sintered Stone



■ 用于岩板直/双边机的磨削

规格 Technical Specification Size:(mm)

编号 Code	外径 D	孔径 H	工作层尺寸 Actual Work Rim Size
A10-6	150	22	15 x 10

Application: It's used for sintered stone on Double Edger.

岩板金刚轮 Diamond Wheel for Sintered Stone



■ 用于岩板异形机的磨削

规格 Technical Specification Size:(mm)

编号 Code	外径 D	孔径 H	岩板厚度 T	粒度 G
A10-3	150	22	6,8,10	1#,2#

Application: It's used for sintered stone on Shape Machine.

岩板周齿轮 Protill Segmented Diamond Wheel for Sintered Stone

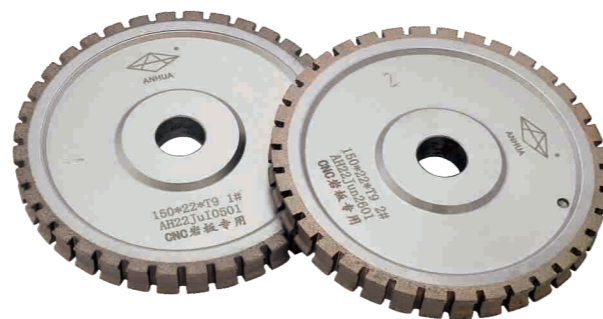

■ 用于岩板CNC/异形机的磨削

规格 Technical Specification Size:(mm)

编号 Code	外径 D	孔径 H	粒度 G
A10-4	150	22	6,8,10,11,12,15

Application: It's used for sintered stone on CNC working center or Shape Machine.

岩板内孔磨轮 Small Diamond Wheels for Sintered Stone



■ 用于岩板CNC/异形机的磨削

规格 Technical Specification Size:(mm)

编号 Code	外径 D	孔径 H	岩板厚度 Actual Work Rim Size	粒度 G
A10-7	35/50	22	6,8,10,12,15	1#,2#

Application: It's used for innerhole grinding on Shape Machine.

异形斜边岩板金刚轮 Full segmented Diamond Wheel For Sintered Stone On Shape Bevel



■ 用于岩板异形斜边机的磨削

规格 Technical Specification Size:(mm)

编号 Code	外径 D	孔径 H	工作层尺寸 Actual Work Rim Size	粒度 G
A10-8	150	22	15X10	40

Application: It's used for sintered stone bevel on Shape Machine.

注：特殊尺寸可按要求订做。Remarks:Different specifications are available if request.

注：特殊尺寸可按要求订做。Remarks:Different specifications are available if request.



树脂轮系列

RESIN WHEEL SERIES

- 斜边机树脂轮
- 双边机树脂轮
- 异形斜边树脂轮
- 直边机树脂轮

树脂轮系列

RESIN WHEEL SERIES



4

树脂轮系列

绿砂密通齿树脂轮(高速) Resin Cup Wheel(Segmented)



■ 用于直边机、双边机及夹胶玻璃

规格 Technical Specification Size:(mm)

编号 Code	外径 D	孔径 H	工作层尺寸 Actual Work Rim Size	粒度 G
B1-1	175	12,22,50	20 × 12	180,240
	150	12,22,50	20 × 12	180,240
	130	12,22,50	20 × 12	180,240

Application: It is used for big removal or laminated on edging machine and double edging machine.

绿砂密齿树脂轮(高速) Resin Cup Wheel(Turbo)



■ 用于直边机、双边机及夹胶玻璃

规格 Technical Specification Size:(mm)

编号 Code	外径 D	孔径 H	工作层尺寸 Actual Work Rim Size	粒度 G
B1-2	175	12,22,50	20 × 12	180,240
	150	12,22,50	20 × 12	180,240
	130	12,22,50	20 × 12	180,240

Application: It is used for big removal or laminated on edging machine and double edging machine.

优质黑砂树脂轮 Resin Cup Wheel(Black Rim)



■ 用于直边机、双边机

规格 Technical Specification Size:(mm)

编号 Code	外径 D	孔径 H	工作层尺寸 Actual Work Rim Size	粒度 G
B1-3	175	12,22,50	10 × 12,15 × 10, 20 × 10	180, 240, 320
	150	12,22,25,50	10 × 12,15 × 10, 20 × 10	180, 240, 320
	130	12,22,50	10 × 12,15 × 10	180, 240, 320
	100	12,50	10 × 12	180, 240, 320

Application: It is used for edging machine and double edging machine, excellent lines removal function.

绿砂树脂轮 Resin Cup Wheel(Standard Green)



■ 用于直边机、双边机

规格 Technical Specification Size:(mm)

编号 Code	外径 D	孔径 H	工作层尺寸 Actual Work Rim Size	粒度 G
B1-4	175	12,22,50	10 × 12,15 × 10, 20 × 10	180, 240, 320
	150	12,22,50	10 × 12,15 × 10, 20 × 10	180, 240, 320
	130	12,22,50	10 × 12,15 × 10, 20 × 10	180, 240, 320
	100	12,50	10 × 12	180, 240, 320

Application: It is used for edging machine and double edging machine.

注: 特殊尺寸可按要求订做。Remarks: Different specifications are available if request.

碗型树脂轮 Resin Wheel (Bowl Shape)



■ 用于斜边机
规格 Technical Specification Size:(mm)

编号 Code	外径 D	孔径 H	工作层尺寸 Actual Work Rim Size	粒度 G
B2-1	150	12,22	15 × 12	3#, 4#, 5#, 6#, 7#

Application: It is used on beveling machine, for mirror beveling

杯型带齿树脂轮 Resin Cup Wheel(turbo)



■ 用于斜边机
规格 Technical Specification Size:(mm)

编号 Code	外径 D	孔径 H	工作层尺寸 Actual Work Rim Size	粒度 G
B2-2	150	12,22	20 × 10	3#, 4#, 5#, 6#, 7#

Application: It is used on beveling machine, for architectural glass bevelling, with high efficiency

三色轮 Three-band Resin Wheel (Aluminum Body)



■ 用于异形斜边机
规格 Technical Specification Size:(mm)

编号 Code	外径 D	孔径 H	工作层尺寸 Actual Work Rim Size	粒度 G
B3-1	150	12,22	15 × 10	粗, 中, 细

Application: It is used for shape-beveling machine, intergrating coarse, medium, fine grits in one wheel.

三色轮 Three-band Resin Wheel



■ 用于异形斜边机
规格 Technical Specification Size:(mm)

编号 Code	外径 D	孔径 H	工作层尺寸 Actual Work Rim Size	粒度 G
B3-2	150	12,22	15 × 10	粗, 中, 细

Application: It is used for shape-beveling machine, intergrating coarse, medium, fine grits in one wheel.

日利树脂轮 RiLi Resin Cup Wheel(Green Base)



■ 用于斜边机
规格 Technical Specification Size:(mm)

编号 Code	外径 D	孔径 H	工作层尺寸 Actual Work Rim Size	粒度 G
B2-3	150	12,22	10 × 10, 15 × 10	3#, 4#, 5#, 6#, 7#

Application: It is used for edging machine and double edging machine excellent lines removal function.

碗形带齿树脂轮 Bowl Resin Wheel(Turbo)



■ 用于斜边机
规格 Technical Specification Size:(mm)

编号 Code	外径 D	孔径 H	工作层尺寸 Actual Work Rim Size	粒度 G
B2-4	150	12,22	16 × 10	3#, 4#, 5#, 6#, 7#

Application: It is used for beveling machine.

异形斜边树脂轮 Shape-beveling Resin Wheel



■ 用于异形斜边机
规格 Technical Specification Size:(mm)

编号 Code	外径 D	孔径 H	工作层尺寸 Actual Work Rim Size	粒度 G
B3-3	150	12,22	15 × 10	120, 180, 240

Application: It is used for shape-beveling machine.

玻璃效果图

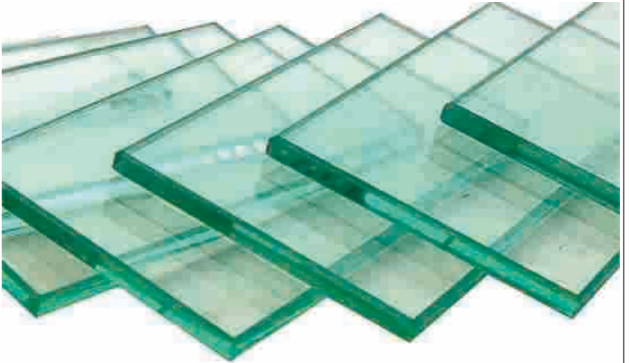

注：特殊尺寸可按要求订做。Remarks: Different specifications are available if request.

注：特殊尺寸可按要求订做。Remarks: Different specifications are available if request.



抛光轮系列 (一)

- 10S抛光轮
- X-5000精抛轮
- CE-3精抛轮



10S抛光轮 Standard 10S Polishing Wheel



规格 Technical Specification Size:(mm)

编号 Code	外径 D	孔径 H	磨轮厚度 T	粒度 G
C1-1	170	70	40	40,60, 80, 120
	150	22, 50, 68, 70	40, 35, 30	40,60, 80, 120
	125,130	22, 50, 60	35	40,60, 80
	100	60	35	40,60, 80

优质10S抛光轮 Upgraded 10S Polishing Wheel



规格 Technical Specification Size:(mm)

编号 Code	外径 D	孔径 H	磨轮厚度 T	粒度 G
C1-2	170	70	40	40,60, 80, 120
	150	22, 50, 68, 70	40, 35, 30	40,60, 80, 120
	125,130	22, 50, 60	35	40,60, 80
	100	60	35	40,60, 80

带座10S抛光轮 Standard 10S Polishing with Base

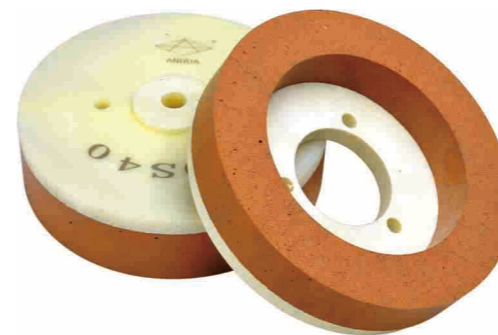

规格 Technical Specification Size:(mm)

编号 Code	外径 D	孔径 H	磨轮厚度 T	粒度 G
C1-3	170	68	40	40,60, 80, 120
	150	12, 22, 50	40	40,60, 80, 120
	125,130	12, 22, 50	35	40,60, 80

优质带座10S抛光轮 Upgraded 10S Polishing with Base



规格 Technical Specification Size:(mm)

编号 Code	外径 D	孔径 H	磨轮厚度 T	粒度 G
C1-4	170	68	40	40,60, 80, 120
	150	12, 22, 50	40	40,60, 80, 120
	125, 130	12, 22, 50	35	40,60, 80

注：特殊尺寸可按要求订做。Remarks: Different specifications are available if request.

窄边10S抛光轮 Standard 10S Polishing with Rim 13mm

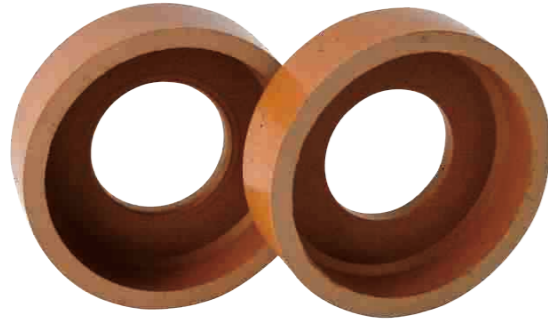

规格 Technical Specification Size:(mm)

编号 Code	外径 D	孔径 H	磨轮厚度 T	环宽 Rim	粒度 G
C1-5	150	70	40	13	40,60

优质窄边10S抛光轮 Upgraded 10S Polishing with Rim 13mm

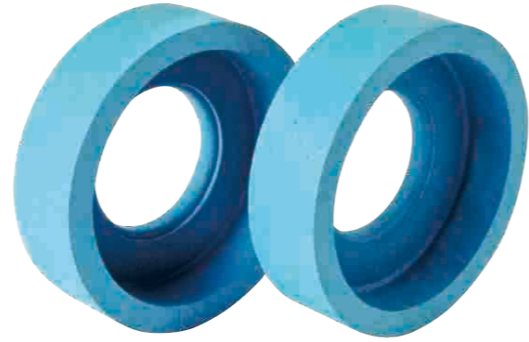

规格 Technical Specification Size:(mm)

编号 Code	外径 D	孔径 H	磨轮厚度 T	环宽 Rim	粒度 G
C1-6	150	70	40	13	40,60

CE-3 精抛轮 CE-3 Polishing

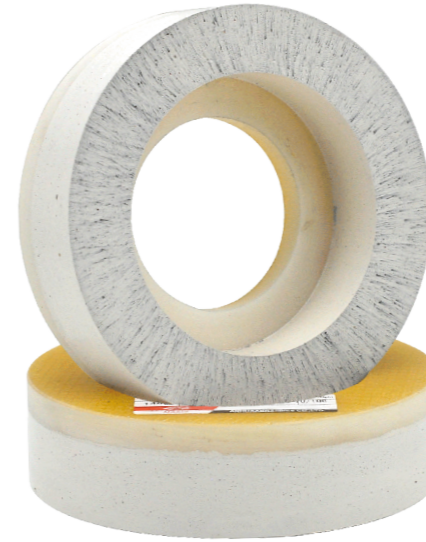

规格 Technical Specification Size:(mm)

编号 Code	外径 D	孔径 H	磨轮厚度 T
C2-1	170	70	40
	150	22,70	40

X5000 精抛轮 X5000 Cerium Wheel



规格 Technical Specification Size:(mm)

编号 Code	外径 D	孔径 H	磨轮厚度 T
C2-2	150	22,50, 68, 70	40, 30

9R 抛光轮 Standard 9R Polishing Wheel



规格 Technical Specification Size:(mm)

编号 Code	外径 D	孔径 H	磨轮厚度 T	粒度 G
C1-7	150	70	40	40,60,80

优质9R 抛光轮 Upgraded 9R Polishing Wheel



规格 Technical Specification Size:(mm)

编号 Code	外径 D	孔径 H	磨轮厚度 T	粒度 G
C1-8	150	70	40	40,60,80

CX09 Cx09 Polishing Wheel



规格 Technical Specification Size:(mm)

编号 Code	外径 D	孔径 H	磨轮厚度 T
C2-3	150	70	30

玻璃效果图

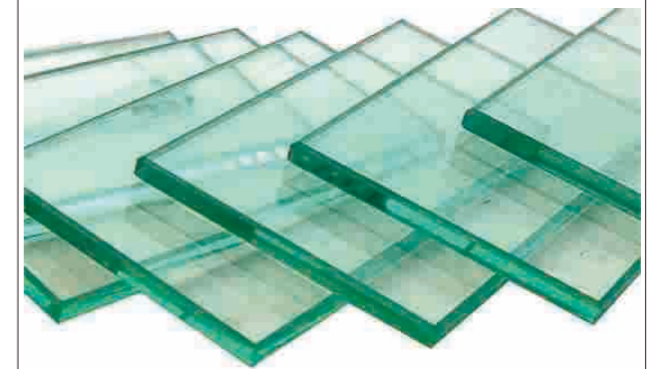

注：特殊尺寸可按要求订做。Remarks:Different specifications are available if request.

注：特殊尺寸可按要求订做。Remarks:Different specifications are available if request.

杯形 BK 抛光轮 BK Cup Polishing Wheel



规格 Technical Specification Size:(mm)

编号 Code	外径 D	孔径 H	磨轮厚度 T	粒度 G
C3-1	150	22,50,68,70	40	40,60,80,120
	170	22,50,60	35	40,60

带座 BK 抛光轮 BK Cup Polishing Wheel with Base



规格 Technical Specification Size:(mm)

编号 Code	外径 D	孔径 H	磨轮厚度 T	粒度 G
C3-2	150	50	40	40,60,80,120

平行硬 BD 抛光轮 BD Polishing Wheel(Hard)



规格 Technical Specification Size:(mm)

编号 Code	外径 D	孔径 H	磨轮厚度 T
C4-1	100,150,200	22	15,20,25,30

平行软BD抛光轮 BD Polishing Wheel (Soft)



规格 Technical Specification Size:(mm)

编号 Code	外径 D	孔径 H	磨轮厚度 T
C4-2	100,150,200	22	15,20,25,30

平行 BK 抛光轮 BK Peripheral Polishing Wheel



规格 Technical Specification Size:(mm)

编号 Code	外径 D	孔径 H	磨轮厚度 T	粒度 G
C3-3	100,150,200	22	15,20,25,30	40,60,80,120,180,240

圆边机 BK 抛光轮 BK Peripheral Polishing Wheel for Round Edger



规格 Technical Specification Size:(mm)

编号 Code	外径 D	孔径 H	磨轮厚度 T	粒度 G
C3-4	200	90	15,20,25,30	40,60,80,120,180,240

平行绿BD抛光轮 Green BD Polishing Wheel



规格 Technical Specification Size:(mm)

编号 Code	外径 D	孔径 H	磨轮厚度 T
C4-3	100,150,200	22	15,20,25,30

CNC BD 轮 BD Polishing Wheel for CNC Machine



规格 Technical Specification Size:(mm)

编号 Code	外径 D	孔径 H	磨轮厚度 T
C4-4	100, 120	22	15, 20, 25, 30

Application: BD polishing wheel with inner cooling system, which is special for CNC Machine.

注：特殊尺寸可按要求订做。Remarks:Different specifications are available if request.

注：特殊尺寸可按要求订做。Remarks:Different specifications are available if request.

圆边机 BD 抛光轮 BD Polishing Wheel (Soft & Hard)



规格 Technical Specification Size:(mm)

编号 Code	外径 D	孔径 H	磨轮厚度 T
C4-5	200	90	15,20,25,30

特殊 BD 抛光轮 Small BD Polishing Wheel



规格 Technical Specification Size:(mm)

编号 Code	外径 D	孔径 H	磨轮厚度 T
C4-6	25, 30	12	25, 30, 35
	50	22	15, 20, 25, 30

带座 BD 抛光轮 BD Polishing with Base



规格 Technical Specification Size:(mm)

编号 Code	外径 D	孔径 H	磨轮厚度 T
C4-7	125	12, 25, 50	45
	150	12, 25, 50	45

刻花 BD 轮 BD V- Engraving Wheel



规格 Technical Specification Size:(mm)

编号 Code	外径 D	孔径 H	磨轮厚度 T
C4-8	140, 150	22	5, 6, 8, 10, 12
	160, 200	22, 40, 50, 90	5, 6, 8, 10, 12

注：特殊尺寸可按要求订做。Remarks:Different specifications are available if request.

LOW-E 玻璃除膜轮系列

LOW-E GLASS COATING DELETION WHEEL SERIES

- 干除膜轮 ■
- 湿除膜轮 ■
- 特殊规格除膜轮 ■



抛光轮系列 (二)

POLISHING WHEEL SERIES (2)

- BD 抛光轮 ■
- BK 抛光轮 ■
- 羊毛轮 ■
- 石头轮 ■

优质蓝标羊毛轮 Spiral Felt Wheel (Standard)



规格 Technical Specification Size:(mm)

编号 Code	外径 D	孔径 H	磨轮厚度 T
C5-1	150	70,105	25, 35, 40
	185	115	25, 35, 40

优质绿标羊毛轮 Spiral Felt Wheel (Upgraded)



规格 Technical Specification Size:(mm)

编号 Code	外径 D	孔径 H	磨轮厚度 T
C5-2	150	70,105	25, 35, 40
	185	115	25, 35, 40

普通羊毛轮 Spiral Felt Wheel



规格 Technical Specification Size:(mm)

编号 Code	外径 D	孔径 H	磨轮厚度 T
C5-3	150	70,105	25, 35, 40
	185	115	25, 35, 40

蓝色羊毛轮 Spiral Felt(Blue)

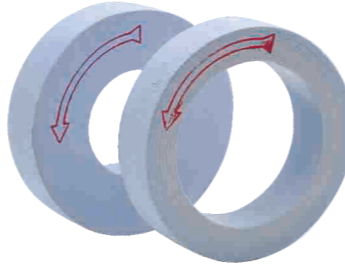

规格 Technical Specification Size:(mm)

编号 Code	外径 D	孔径 H	磨轮厚度 T
C5-4	150	70,105	25, 35, 40
	185	115	25, 35, 40

氧化铈羊毛轮 Spiral Felt Wheel with Cerium Oxide



规格 Technical Specification Size:(mm)

编号 Code	外径 D	孔径 H	磨轮厚度 T
C5-5	150	70, 105	25, 35, 40

澳毛纯羊毛轮 Pure Wool Felt



规格 Technical Specification Size:(mm)

编号 Code	款式 Type	外径 D	孔径 H	磨轮厚度 T
C5-6	A	150, 200, 250, 300	22	25, 30, 35, 40
	B	150	70	40

注：特殊尺寸可按要求订做。Remarks:Different specifications are available if request.

杯形石头轮 Stone Wheel



规格 Technical Specification Size:(mm)

编号 Code	外径 D	孔径 H	磨轮厚度 T
C6-1	150	12, 22, 50, 70	40
	130	12, 22, 50, 70	35,40

石头轮 Stone Wheel



规格 Technical Specification Size:(mm)

编号 Code	外径 D	孔径 H	磨轮厚度 T
C6-2	100	12, 22, 50	40

石头轮功能介绍

石头轮主要用于玻璃倒角用，前不需要用金刚轮，后面也不需要抛光轮，可以单独倒角，磨出来的效果非常光亮。因此，此产品可以大大节省公司生产成本。石头轮一经问世就收到广大企业的青睐。平行石头轮主要用于玻璃倒安全角，代替倒角BD轮，耐磨度更高。

Stone Wheel

Stone wheel series are mainly used for making and polishing arris as well , no need diamond wheel before it , only one wheel can obtain excellent performance on the arris . It' s well welcomed by glass processing factories because it can save much cost . The periheral one has longer life than BD polishing , which is mainly used for making and polishing safety arris of glass , so many factories always use it in place of BD polishing.

石头轮工作示意图

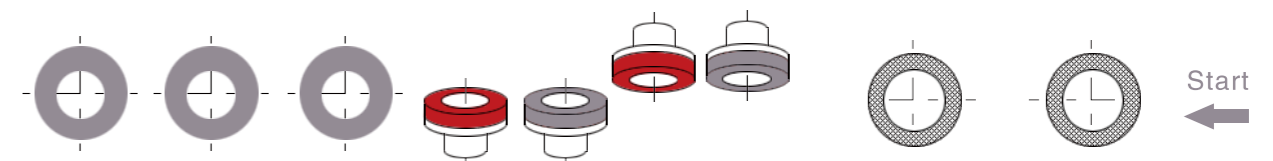

注：特殊尺寸可按要求订做。Remarks:Different specifications are available if request.

5

抛光轮系列

进口10S抛光轮 R.B.M. 10S Polishing Wheel



规格 Technical Specification Size:(mm)

编号 Code	外径 D	孔径 H	磨轮厚度 T	粒度 G
C7-1	170	70	40	40, 60
	150	70	40, 35, 30	40, 60, 80, 120
	130	60	35	40, 60, 80

进口9R抛光轮 R.B.M. 9R Polishing Wheel



规格 Technical Specification Size:(mm)

编号 Code	外径 D	孔径 H	磨轮厚度 T	粒度 G
C7-2	150	70	40	40, 60, 80
	130	60	35	40, 60

进口9RS抛光轮 R.B.M. 9RS Polishing Wheel



规格 Technical Specification Size:(mm)

编号 Code	外径 D	孔径 H	磨轮厚度 T	粒度 G
C7-3	150	50	40	40,60,80

进口窄边10S抛光轮 R.B.M. 10S Polishing Wheel with Rim 13mm



规格 Technical Specification Size:(mm)

编号 Code	外径 D	孔径 H	厚度 T	环宽 T	粒度 G
C7-4	150	70	40	12	40,60

进口开齿10S抛光轮 R.B.M. 10S Polishing Wheel Segmented



规格 Technical Specification Size:(mm)

编号 Code	外径 D	孔径 H	磨轮厚度 T	粒度 G
C7-5	150	70	40	40,60

进口开齿9RS抛光轮 R.B.M. 9RS Polishing Wheel Segmented



规格 Technical Specification Size:(mm)

编号 Code	外径 D	孔径 H	磨轮厚度 T	粒度 G
C7-6	150	70	40	40,60

注：特殊尺寸可按要求订做。Remarks:Different specifications are available if request.

6

进口抛光轮系列

进口9RS抛光轮 R.B.M. 9RS Polishing Wheel Segmented



规格 Technical Specification Size:(mm)

编号 Code	外径 D	孔径 H	磨轮厚度 T	粒度 G
C7-7	150	50/90	30	40,60

进口10s抛光轮 R.B.M. 10S Polishing Wheel



规格 Technical Specification Size:(mm)

编号 Code	外径 D	孔径 H	磨轮厚度 T	粒度 G
C7-8	130	22	35	40,60,80
	150	22	40	40,60,80

进口HS40高速抛光轮 R.B.M. HS Polishing Wheel (for High Speed)



规格 Technical Specification Size:(mm)

编号 Code	外径 D	孔径 H	磨轮厚度 T
C7-9	150	70	40

进口RR40抛光轮 R.B.M. RR Polishing Wheel



规格 Technical Specification Size:(mm)

编号 Code	外径 D	孔径 H	磨轮厚度 T
C7-10	150	70	40

注：特殊尺寸可按要求订做。Remarks:Different specifications are available if request.

进口X081抛光轮 R.B.M. X081 Polishing Wheel



规格 Technical Specification Size:(mm)

编号 Code	外径 D	孔径 H	磨轮厚度 T
C7-11	150	70	30

进口X09抛光轮 R.B.M. X09 Polishing Wheel



规格 Technical Specification Size:(mm)

编号 Code	外径 D	孔径 H	磨轮厚度 T
C7-12	150	70	40

进口异形斜边 BK 抛光轮 Imported BK Polishing Wheel for Shape Beveling Machine

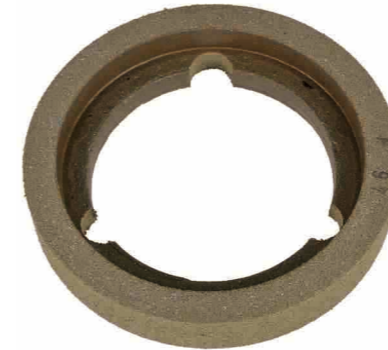

规格 Technical Specification Size:(mm)

编号 Code	外径 D	孔径 H	磨轮厚度 T	粒度 G
C7-17	150	100	25	46,60

进口BK抛光轮 Artifex BK Polishing Wheel



规格 Technical Specification Size:(mm)

编号 Code	外径 D	孔径 H	磨轮厚度 T	粒度 G
C7-18	150	70	40	46,60
	130	60	35	46,60

进口石头轮 R.B.M. MB3 Polishing Wheel



规格 Technical Specification Size:(mm)

编号 Code	外径 D	孔径 H	磨轮厚度 T
C7-13	150	70, 12	40
	130	60, 12	35

进口石头轮 R.B.M. MB3 Polishing Wheel



规格 Technical Specification Size:(mm)

编号 Code	外径 D	孔径 H	磨轮厚度 T
C7-14	100	12	45

进口 AO 轮 Artifex AO Polishing Wheel



规格 Technical Specification Size:(mm)

编号 Code	外径 D	孔径 H	磨轮厚度 T	粒度 G
C7-19	150	50, 70	40	40,60

进口 BJ AO 轮 Artifex BJ AO Polishing Wheel



规格 Technical Specification Size:(mm)

编号 Code	外径 D	孔径 H	磨轮厚度 T	粒度 G
C7-20	150	70	40	60

进口卷状羊毛轮 Imported Spiral Felt Wheel



规格 Technical Specification Size:(mm)

编号 Code	外径 D	孔径 H	磨轮厚度 T
C7-15	150	70	35
	150	105	35

进口高密纯羊毛轮 Imported Pure Wool Felt Wheel



规格 Technical Specification Size:(mm)

编号 Code	外径 D	孔径 H	磨轮厚度 T
C7-16	150	70	40
	200, 150	22	40

进口 CE-3 Artifex CE-3 Polishing Wheel



规格 Technical Specification Size:(mm)

编号 Code	外径 D	孔径 H	磨轮厚度 T
C7-21	170	70	40
	150	70	40

进口WEL抛光轮 Artifex WEL Polishing Wheel



规格 Technical Specification Size:(mm)

编号 Code	外径 D	孔径 H	磨轮厚度 T	粒度 G
C7-22	150	70	40	600,800

注：特殊尺寸可按要求订做。Remarks:Different specifications are available if request.

注：特殊尺寸可按要求订做。Remarks:Different specifications are available if request.

LOW-E 进口材料除膜轮 Coating Deletion Wheel (Dry Use)



规格 Technical Specification Size:(mm)

编号 Code	外径 D	孔径 H	磨轮厚度 T
D-1	200	76.2	8,10,12,15,20,25,30

LOW-E 玻璃除膜轮(单银、双银、三银) Coating Deletion Wheel (Dry Use)



规格 Technical Specification Size:(mm)

编号 Code	外径 D	孔径 H	磨轮厚度 T
D-2	200	76.2	8,10,12,15,20,25,30

湿除膜轮 Coating Deletion Wheel (Wet Use)



规格 Technical Specification Size:(mm)

编号 Code	外径 D	孔径 H	磨轮厚度 T
D-3	150,200	22,50,76.2	8,10,12,15,20,25

孔位除膜轮 Coating Deletion Wheel (Dry Use)



规格 Technical Specification Size:(mm)

编号 Code	外径 D	孔径 H	磨轮厚度 T
D-4	50,60,65	6	6,8,10,15,20,25,30

注：特殊尺寸可按要求订做。Remarks: Different specifications are available if request.



玻璃钻铣系列

MILLING TOOLS / DRILL BITS SERIES

- 整体钻、整体倒角器 ■ 其它定制带柄磨头 ■
- 烧结钻、烧结倒角器 ■ 电镀钻、倒角器 ■
- CNC铣刀、内孔磨头 ■ 水嘴、连接头 ■
- 倒角套 ■ 白刚玉 ■

8

玻璃钻铣系列

组合铣刀 Combi Tools for Milling+Edging



规格 Technical Specification Size:(mm)

编号 Code	规格 Spec
E1-1	FE-FA6 SS CC 15x95 YG1/2
	FE-FA8 SS CC 15x105 YG1/2
	FE-FA10 SS CC 15x105 YG1/2
	FE-FA12 SS CC 15x105 YG1/2

铣刀 Router / Milling



规格 Technical Specification Size:(mm)

编号 Code	规格 Spec	刀头长度 Diamond Length
E1-2	75x10x3, 75x12x3	25
	80x14x4, 80x16x4, 80x18x4 80x20x5, 80x22x5, 80x22x6 80x24x5, 80x24x6, 80x26x5, 80x26x6	40

CNC内孔磨轮 CNC Trap Wheels(General Style)



规格 Technical Specification Size:(mm)

编号 Code	长度 Total Height	铣刀规格 Size of Router Part	玻璃厚度 Glass Thickness
E1-5	75	15,20,25	4,6,8,10,12,15,19
	95	15,20,25	4,6,8,10,12,15,19
	108	15,20,25	4,6,8,10,12,15,19

Remark:Belgium type Gas1/2", with inner cooling water flows

整体倒角器 Countersink Bits with Thread (General Style)



规格 Technical Specification Size:(mm)

编号 Code	长度 Total Height	直径 Dia
E1-6	75mm	0-16 to 0-80mm
	95mm	0-16 to 0-80mm

Remark:Belgium Type Gas 1/2", with inner cooling water flows

8

玻璃钻铣系列

铣刀 Router / Milling



规格 Technical Specification Size:(mm)

编号 Code	规格 Spec	刀头长度 Diamond Length
E1-3	108x10x4, 108x16x5, 108x20x5	20

铣刀(直筋) Router / Milling



规格 Technical Specification Size:(mm)

编号 Code	规格 Spec	刀头长度 Diamond Length
E1-4	75x10x4, 75x12x4	25

金刚石钻头 Diamond Drill



规格 Technical Specification Size:(mm)

编号 Code	长度 Total Height	直径 Dia
E2-1	75mm	4-80mm
	95mm	4-80mm

Remark:Belgium type Gas1/2", steel body painted to rust resistance.

金刚石钻头 Diamond Drill Special for 2-4mm Glass



规格 Technical Specification Size:(mm)

编号 Code	长度 Total Height	直径 Dia
E2-2	75mm	4-100mm
	95mm	4-100mm

Remark:Belgium type Gas1/2", steel body, wall thickness 0.6mm, special for2-4MM glass

特殊金刚石钻头 Special Diamond Drill



规格 Technical Specification Size:(mm)

编号 Code	长度 Total Height	直径 Dia
E2-3	75mm	81-160mm
	95mm	81-160mm

Remark:Belgium type Gas1/2", steel body .

烧结钻 Diamond Drill



规格 Technical Specification Size:(mm)

编号 Code	直径 Dia
E2-4	4-150mm

Remark:Cone Shank&Straight Shank

注：特殊尺寸可按要求订做。Remarks:Different specifications are available if request.

注：特殊尺寸可按要求订做。Remarks:Different specifications are available if request.

8

玻璃钻铣系列

倒角套 Countersink



规格 Technical Specification Size:(mm)

编号 Code	壁厚 Wall Thickness	直径 Dia
E2-5	3.5mm	5-130mm
	5mm	5-130mm

免磨倒角套 Countersink (Dressing-free)



规格 Technical Specification Size:(mm)

编号 Code	直径 Dia
E3-1	5-130mm

烧结倒角器 Countersink Bits(General Style)



规格 Technical Specification Size:(mm)

编号 Code	直径 Dia
E4-1	0-8 to 0-80mm

特殊整体倒角器 Special Countersink Bits wish Thread



规格 Technical Specification Size:(mm)

编号 Code	长度 Total Height	直径 Dia
E4-2	定做 Customized	定做 Customized

8

玻璃钻铣系列

免磨整体钻头 Diamond Drill (Dressing-free)



规格 Technical Specification Size:(mm)

编号 Code	长度 Total Height	直径 Dia
E3-2	75mm	4-45mm
	95mm	4-45mm

Remark:Belgium type Gas1/2",steel body.

免磨烧结钻 Diamond Drill (Dressing-free)



规格 Technical Specification Size:(mm)

编号 Code	直径 Dia
E3-3	4-150mm

Remark:Cone Shank&Straight Shank

带柄金刚石磨头 Straight Shank FE Diamond Grinding Bit



规格 Technical Specification Size:(mm)

编号 Code	直径 Dia
E4-3	定做 Customized

Remark:FE style& straight shank

带柄金刚石磨头 Straight Shank FA Diamond Grinding Bit



规格 Technical Specification Size:(mm)

编号 Code	直径 Dia
E4-4	定做 Customized

Remark:FE style& straight shank

钻盘&钻片 Cricle Cutter Disc and its Cutters

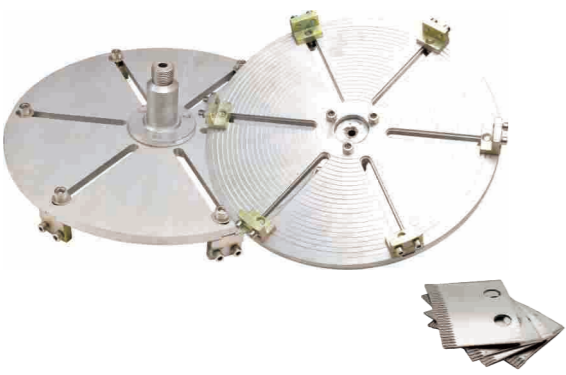

规格 Technical Specification Size:(mm)

编号 Code	规格 Spec
E3-4	60-200mm, 60-250mm, 60-300mm, 60-350mm

白刚玉、油石条 Dressing Stone



规格 Technical Specification Size:(mm)

编号 Code	规格 Spec	粒度 G
E3-5	150 x 25 x 15	80,100
	120 x 25 x 15	80,100

其他规格可按要求定做 Different specification are available request.

电镀直柄钻头 Electroplated Straight Shank Core Drill



规格 Technical Specification Size:(mm)

编号 Code	钻头直径 Dia
E5-1	3-150mm

电镀倒角器 Electroplated Countersink Bit



规格 Technical Specification Size:(mm)

编号 Code	钻头直径 Dia
E5-2	0-15 to 0-60mm

注：特殊尺寸可按要求订做。Remarks:Different specifications are available if request.

注：特殊尺寸可按要求订做。Remarks:Different specifications are available if request.

- 铝托盘/铝托座
- 其他配件
- 压板/链条
- 防水套
- 水泵/电机

8

玻璃钻铣系列

三角钻 TCT Drill Bits



规格 Technical Specification Size:(mm)

编号 Code	规格 Spec
E5-3	4mm,5mm,6mm

连接头 Adapter



规格 Technical Specification Size:(mm)

编号 Code	E5-4
------------	------

打孔机水嘴 Water Chuck for Drilling Machine



规格 Technical Specification Size:(mm)

编号 Code	E5-5
------------	------

水嘴(连接直柄钻) Water Chuck for Straight Shank Drill Bit



规格 Technical Specification Size:(mm)

编号 Code	E5-6
------------	------

水嘴(连接锥柄钻) Water Chuck for Cone Shank Drill Bit

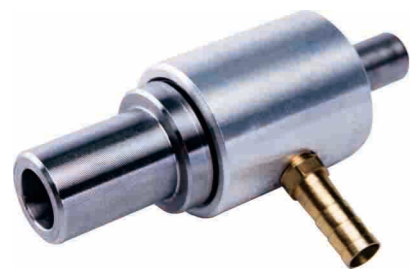

规格 Technical Specification Size:(mm)

编号 Code	E5-7
------------	------

水嘴(连接整体钻) Water Chuck for Thread Drill Bit



规格 Technical Specification Size:(mm)

编号 Code	E5-8
------------	------

注：特殊尺寸可按要求订做。Remarks: Different specifications are available if request.



铝托盘 Aluminum Mounting Plate



编号 Code F1-1

铝托座 Aluminum Base



编号 Code F1-2

电机、水泵 Motor / Water Pump

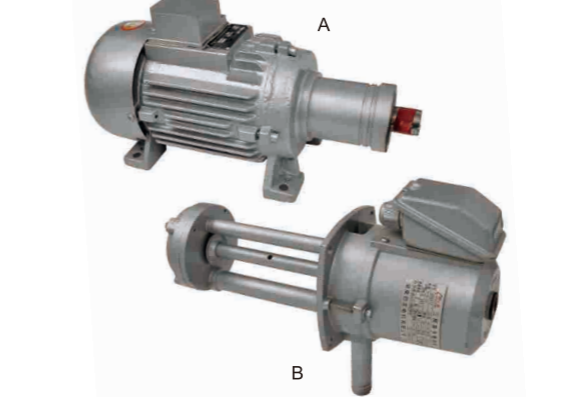

编号 Code F2-4

优质输送链条和斜面胶粒 Upgraded Conveyor Chain & Rubber Pad

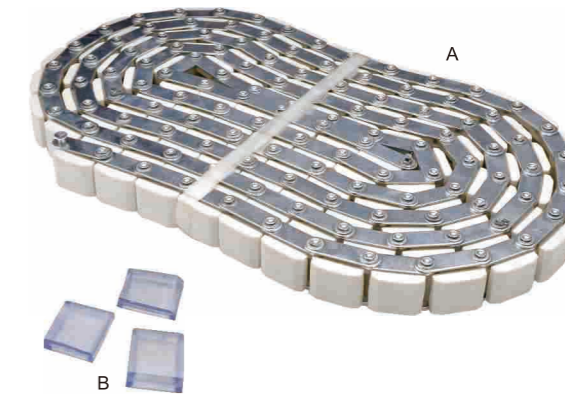

编号 Code F2-5

压盖 Aluminum Fitting



编号 Code F1-3

百节喉水管、接头 Water Pipe/Connector

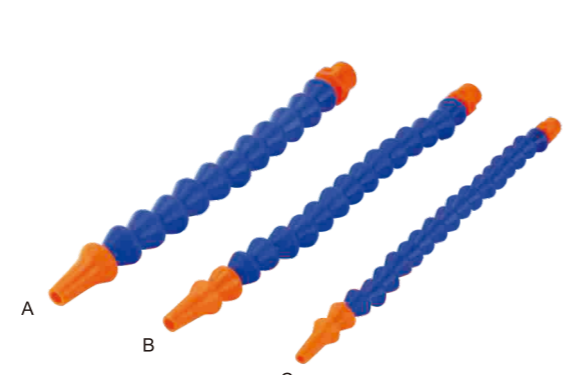

编号 Code F2-1

输送链条和斜面胶粒 Conveyor Chain & Rubber Pad



编号 Code F2-6

直边机防水套 Watercover for Straight-line Edger



编号 Code F2-7

皮带/同步带 Timed Belt



编号 Code F2-2

毛刷 Brush



编号 Code F2-3

直边机压板 Pressure Plate for Straight Line Edging Machine

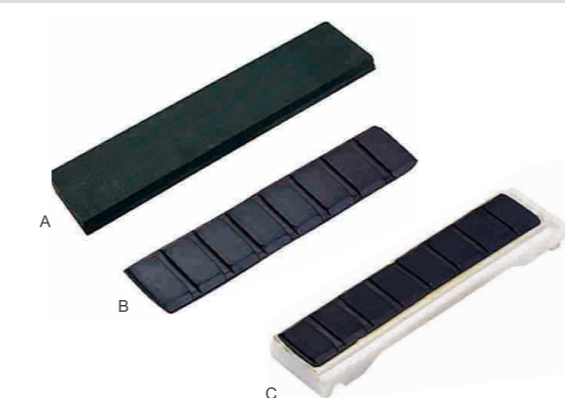

编号 Code F3-1

压板 Pressure Plate(For Bavelloni)



编号 Code F3-2

压板 Pressure Plate

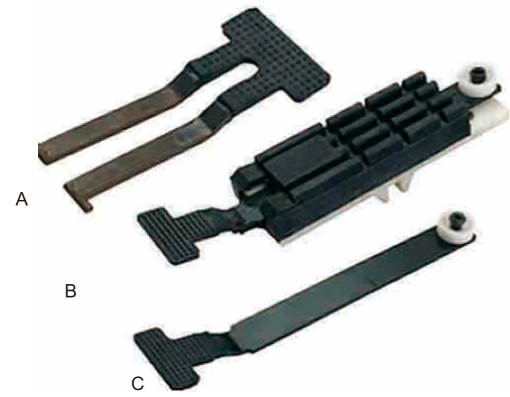

编号
Code F3-3

斜边机后压板定制 Rear Pressure Plate(Customized)

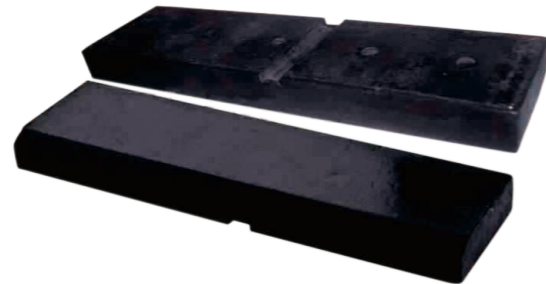

编号
Code F3-4

异型机吸盘 Sucker for Shape Machine



编号
Code F4-1

推拉阀 Switch Valve



编号
Code F4-2

进口真空发生器 Vacuum Generator (Imported)



编号
Code F4-3

真空发生器 Vacuum Generator



编号
Code F4-4

输送铁链条 Supporting Frame Pulley



编号
Code F3-5

靠轮 Support Guide Wheel

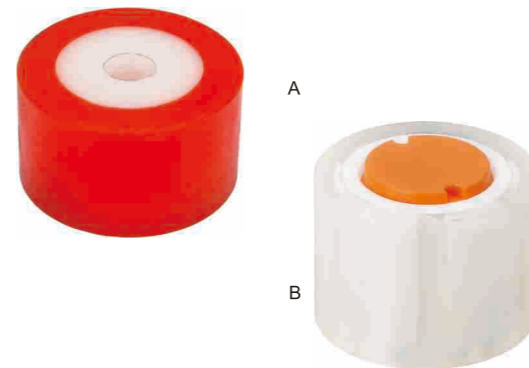

编号
Code F3-6

气缸 Cylinder



编号
Code F4-5

固特继电器 Relay



编号
Code F4-6

靠轮 Support Guide Wheel

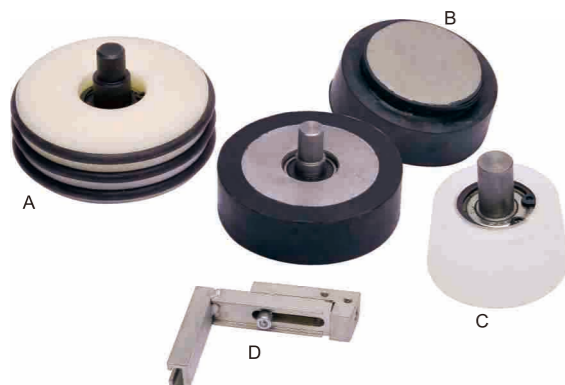

编号
Code F3-7

切割机上片吸盘 Glass Loading Suction for CNC Cutting Table



编号
Code F3-8

U型玻璃护夹 U Type Glass Clip



编号
Code F4-7

数字器 Position Indicator



编号
Code F4-8

万向水管三通接头 Tee Coupling for Universal Water Pipe



编号
Code L4-9

玻璃捆绑绳 Fastening Rope for Glass



编号
Code L5-1

防黑边胶 Mirror Edge Seal



编号
Code F7-1

Application: Keeping the edge of mirror silver from oxygenizing

进口UV胶水 LOXEAL UA Glue



编号 Code	重量 Weight	型号 Type
F7-2	50ml	loxeal 30-23, 30-21
	250ml	loxeal 30-23, 30-21, 30-20

Application: Glass surface to surface applies LOXEAL 30.23
Glass to metal or Glass surface to edge applies LOXEAL 30.21 30.20

钢化炉防火绳 Kevlar Rope and Tape for Toughening Furnace



编号
Code F5-2

绿色圆带 Polyurethane Rope Belt



编号
Code F5-3

手套 Gloves



编号
Code F8-1

护腕 Wristlet



编号
Code F8-2

吊带 Glass Sling



编号
Code F5-4

防水标签 Water Proof Tag



编号
Code F6-1

金刚石手擦 Diamond Hand Pad



编号
Code F9-1

砂带 Sand Belts & Discs

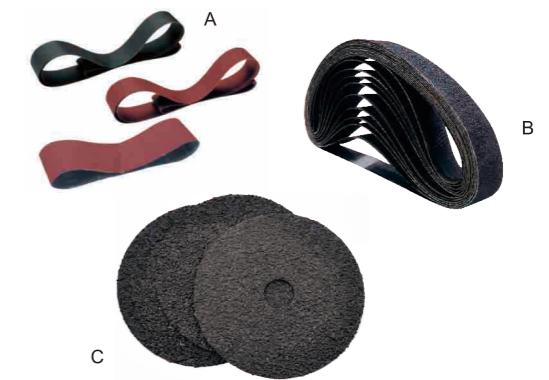

编号
Code F9-2



氧化铈抛光粉 Cerium Oxide



■ 适用于高精密光学镜片，液晶显示屏玻璃，手机屏玻璃等

编号 Code	AN-718
外观 Color	纯白色粉末 White
参数 Parameter	REO≥96% CeO2/REO≥70%
D50	0.8-1.0um
D100	≤3.2um
悬浮性 Suspension	好 Good
包装 Packing	5KG/袋, 25KG/箱, 20-35KG/桶 20kgs/plastic pail, 540kgs/pallet

Application: Excellent Polishing For Precious Optical Lens, LED Screen, Mobile LED Screen Etc.

氧化铈抛光粉 Cerium Oxide



■ 各类光学玻璃,电子玻璃,液晶屏,手机屏,超白镜面,汽车后视镜等

编号 Code	AN-738
外观 Color	红色粉末 Pink
参数 Parameter	REO≥96% CeO2/REO≥70%
D50	1.2-1.3um
D100	≤3.2um
悬浮性 Suspension	好 Good
包装 Packing	20KG/箱 20kgs/plastic pail, 540kgs/pallet

Application: Excellent Polishing For Precious Optical Lens, LED Screen, Mobile LED Screen Etc.

氧化铈抛光粉 Cerium Oxide



■ 适用于高精密光学镜片，液晶显示屏玻璃，手机屏玻璃等

编号 Code	AN-818
外观 Color	纯白色粉末 White
参数 Parameter	REO≥99.9% CeO2/REO≥99.9%
D50	0.8-1.0um
D100	≤3.2um
悬浮性 Suspension	好 Good
包装 Packing	5KG/袋, 25KG/箱, 20-35KG/桶 20kgs/plastic pail, 540kgs/pallet

Application: Excellent Polishing For Precious Optical Lens, LED Screen, Mobile LED Screen Etc.

氧化铈抛光粉 Cerium Oxide



■ 适用于眼镜片,相机镜头,摄像机镜头,棱镜,透镜,过滤镜等

编号 Code	AN-828
外观 Color	红色粉末 Pink
参数 Parameter	REO≥95% CeO2/REO≥70%
D50	1.0-1.2um
D100	≤2.0um
悬浮性 Suspension	好 Good
包装 Packing	5KG/袋, 25KG/箱, 20-35KG/桶 20kgs/plastic pail, 540kgs/pallet

Application: Excellent Polishing For Precious Optical Lens, LED Screen, Mobile LED Screen Etc.

氧化铈抛光粉 Cerium Oxide



■ 普通玻璃的抛光，斜边镜子，马赛克

编号 Code	AN-428
外观 Color	米白色粉末 White
参数 Parameter	REO≥80% CeO2/REO≥50%
D50	1.8-2.0um
D100	≤3.2um
悬浮性 Suspension	一般 Normal
包装 Packing	5KG/袋, 25KG/箱, 20-35KG/桶 20kgs/plastic pail, 540kgs/pallet

Application: Normal Use For Glass Polishing, Beveling Polishing, Mosaic Polishing.

氧化铈抛光粉 Cerium Oxide



■ 普通玻璃的抛光，斜边镜子，马赛克等

编号 Code	AN-438
外观 Color	红色粉末 Pink
参数 Parameter	REO≥80% CeO2/REO≥45%
D50	1.8-2.0um
D100	≤3.2um
悬浮性 Suspension	一般 Normal
包装 Packing	5KG/袋, 25KG/箱, 20-35KG/桶 20kgs/plastic pail, 540kgs/pallet

Application: Normal Use For Glass Polishing, Beveling Polishing, Mosaic Polishing.