

www.glasstoolseshop.com
www.anhuaglasstools.com



ANHUA 广州安华磨具
专注研磨抛光



WASON

广州安华磨具有限公司

广州梓尔颂五金制品有限公司

地址: 广州市天河区东圃汇彩路盈彩街领汇创展商业中心D8栋5楼

电话: 0086-20-82162591 82161536

传真: 0086-20-82160381

E-mail: info@anhuaglasstools.com / info@wasonhardware.com

Http://www.glasstoolseshop.com

Http://www.anhuaglasstools.com

淘 宝: 广州安华玻璃磨具耗材工具店

旺旺号: 安华磨具2010

Address: suite 501, Bldg. D8, Linghui Chuangzhan Commercial
Centre, Yingcai St., Huicai Rd., dongpu, Tianhe District
Guangzhou, China

Tel.: 0086-20-82162591 82161536

Fax: 0086-20-82160381

E-mail: info@anhuaglasstools.com / info@wasonhardware.com

Skype: anhua_glasstools

Http://www.anhuaglasstools.com

所有产品颜色及尺寸仅供参考, 以产品实样为准, 广州安华公司保留最终解释权, 模仿必究。
All sizes and colours of these products are just for reference, please subject to
actual products. All right of explanation reserved, any copying without Anhua
company's written permission is definitely prohibited.



Anhua provides you a powerful technical
support for glass processing
High quality glass tools

广州安华磨具
专注研磨抛光



8

ANHUA





Factory

ANHUA 广州安华磨具 
 专注 研 磨 抛 光

广州安华磨具创立于1990年，历经27载，已成为行业中集产品设计、研发、生产、销售、物流配送及售后服务为一体的综合型领导企业。通过ISO9001:2000德国MPA质量认证。

工厂直销，拥有先进的生产设备，和创新的研发团队，为你量身定制专属的VIP产品。

意大利著名品牌RBM、LOXEAL等中国区代理，保证100%原装进口直销。

汽车玻璃、家电玻璃金刚轮领域中，我司不断钻研创新，取得了飞跃性的突破与发展。

行业首创，微信商城下单系统，种类齐全、操作简单便捷，倡导“购物零风险”理念，品种涵盖玻璃深加工企业中的所有耗材，全力打造玻璃耗材自选、自购的“一站式”商城平台。

“品质保证、客户受益”是安华的一贯宗旨，对客户负责，对产品负责是安华一贯的服务态度，欢迎海内外朋友与安华开展友好合作，共创美好未来。

We are manufacturer of Glass Grinding and Polishing Wheels and Tools for glass deep processing for 27 years, not only the manufacturer and supplier but also the solution provider.

With Advanced Automatic Production Equipment and Innovative Research and Development Team, keeping stable quality continuity and sustainability is the principle and concept to ensure customers lowest-cost but high efficient production.

In the fields of Vehicle Glass and Appliance Glass, our profile diamond wheels have their well reputation on on Price Performance Ratio.

As per Rubber products for Glass Machine Accessories and Simple Glass Hand Tools, we set up dedicated production line.

Regarding international cooperation, we are the authorized Chinese dealer and distributor of RBM ITALIA and LOXEAL etc. 100% original guarantee.

The purpose of our above investments is to make quality control as the responsibility and service to customers and have them one-stop purchase.

We are sure that you will be of well service with our full experience in the glass field.



GLASS TOOLS



P2-11 金刚石磨轮系列
 DIAMOND GRINDING WHEEL SERIES
 双边机金刚轮 / 直边机金刚轮 / 斜边机金刚轮 / 异形机金刚轮 / 其他



P12 四边磨磨轮系列
 DIAMOND WHEELS & RESIN WHEELS FOR FOUR SIDES EDGER
 四边磨金刚轮 / 四边磨树脂轮



P13-15 树脂轮系列
 RESIN WHEEL SERIES
 双边树脂轮 / 直边树脂轮 / 斜边树脂轮 / 异形斜边树脂轮



P16-24 抛光轮系列
 POLISHING WHEEL SERIES
 10S抛光轮 / CE-3、X-5000精抛轮 / BK抛光轮 / BD抛光轮 / 羊毛轮 / 石头轮



P25-27 进口抛光轮系列
 IMPORTED POLISHING WHEELS
 进口10S、9R抛光轮/进口BK、AO抛光轮/进口精抛轮



P28 Low-E玻璃除膜轮系列
 LOW-E GLASS COATING DELETION WHEEL SERIES
 干除磨轮 / 湿除膜轮 / 特殊规格除膜轮



P29-33 玻璃钻头系列
 DIAMOND TOOL SERIES
 电镀钻头、倒角器 / 烧结钻头、倒角器 / 整体钻头、CNC磨头 / 水嘴、连接头

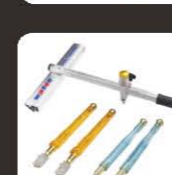

P34-38 手动切割工具系列
 CUTTING TOOLS
 玻璃尺 / T型推刀 / 圆规刀 / 椭圆刀 / 玻璃刀 / 切圆台 / 玻璃钳 / 其他配件



P39-41 吸提搬运工具系列
 SUCTIONS & GLASS SHEETS CARRYING TOOLS
 吸盘 / 吊夹 / 搬运夹 / 软木垫片



P42 UV灯、胶水系列
 UV LAMP,UV GLUE & DETECTORS SERIES
 无影灯 / UV 胶水 / 正反面灯 (锡面仪) / 钢化灯



P43 劳保防护用品、喷砂系列
 SANDING BLASTING SERIES & LABOUR PROTECTION APPLIANCE
 手套 / 护腕 / 防护服 / 喷砂枪 / 枪嘴



P44-46 简易机器设备系列
 POWER TOOLS SERIES
 手提除膜轮 / 手提抛光轮 / 划痕修复机 / 简易钻孔机



P47-50 电动切割、打磨工具系列
 CUTTING & GRINDING TOOLS SERIES
 角磨机/烧结切割片 / 电镀切割片 / 打磨片



P51-57 机械配件系列
 MACHINE FITTING SERIES
 铝托盘、铝托座 / 其他配件 / 压板、链条 / 防水套 / 水泵、电机



P58-59 玻璃辅材、硅酮胶系列
 GLASS AUXILIARY MATERIAL
 玻璃胶/玻璃胶枪/刮胶棉/进口耳塞/其他



60-61 氧化铈抛光系列
 CERIUM OXIDE
 氧化铈抛光粉



金刚石磨轮系列

DIAMOND GRINDING WHEEL SERIES

- 双边机金刚轮
- 斜边机金刚轮
- 直边机金刚轮
- 异形机金刚轮
- 其他

1

金刚石磨轮系列

全齿金刚轮 Segmented Diamond Wheel



■ 用于直边机、双边机的磨削
规格 Technical Specification Size:(mm)

编号 Code	外径 D	孔径 H	工作层尺寸 Actual Work Rim Size	粒度 G
A1-1	150	12,22,25,50	15 × 10,10 × 10	80,100,120,140
	175	12,50	15 × 10	80,100,120,140

Application: It is used for edging machine and for double edging machine as position 1.

弧形全齿金刚轮 Curve Segmented Diamond Wheel



■ 用于直边机、双边机，薄片和厚片通吃，走速快不崩边
规格 Technical Specification Size:(mm)

编号 Code	外径 D	孔径 H	工作层尺寸 Actual Work Rim Size	粒度 G
A1-2	150	12,22,25,50	15 × 10,8 × 10	80, 100
	175	12,22,50	10 × 8 15X10	80, 100

Application: For 3-19mm glass on Edger or Double Edger , as position 1. Fast Feeding Speed.Little Chips.

外半齿金刚轮 Outer Segmental Diamond Wheel



■ 用于直边机、双边机的磨削
规格 Technical Specification Size:(mm)

编号 Code	外径 D	孔径 H	工作层尺寸 Actual Work Rim Size	粒度 G
A1-3	150	12,22,25,50	12 × 10	100,150,240
	175	12,50	12 × 10	100,150

Application: 1.) It is used as position 2 for straight-line edger and double edger;
2.) Special for laminated glass as position 1 & position 2.

内齿金刚轮 Inner Segmented Diamond Wheel



■ 用于直边机、双边机的磨削
规格 Technical Specification Size:(mm)

编号 Code	外径 D	孔径 H	工作层尺寸 Actual Work Rim Size	粒度 G
A1-4	150	12,22,25,50	10 × 8	140,180,240

Application: It is used for edging machine and for double edging machine as position 2.

注：特殊尺寸可按要求订做。Remarks:Different specifications are available if request.

杯形金刚轮 Diamond Cup Wheel



170623 100# Q5

■ 用于直边机、双边机的磨削
规格 Technical Specification Size:(mm)

编号 Code	外径 D	孔径 H	工作层尺寸 Actual Work Rim Size	粒度 G
A1-5	175	12,50	8×8	100,140,180,240
	150	12,22,25,50	8×8	100,140,180,240
	130	12,22,50	8×8	240,320
	100	12,22,50	8×8	240,320

Application: It is used for edging machine and double edging machine.

外齿金刚轮 Outer Segmented Diamond Wheel



170623 100# Q5

■ 用于斜边机的磨削
规格 Technical Specification Size:(mm)

编号 Code	外径 D	孔径 H	工作层尺寸 Actual Work Rim Size	粒度 G
A2-1	150	12,22,25,50	8×10	100,140,180

Application: It is used for beveling machine.

Q4 圆边/直边金刚轮 Standard Diamond Profile Wheel PE / FA



■ 用于直线圆/直边及异形机圆/直边的磨削
规格 Technical Specification Size:(mm)

编号 Code	外径 D	孔径 H	玻璃厚度 G.T	粒度 G
A3-1	80,100,150,175,200	22	2,3,4,5,6,8,10,12,15,19	80,150,180,240

Application: It is used for pencil edge / flat with arris on shape machine.

圆边金刚轮 Diamond Profile Wheel for Schiatti



■ 用于意大利Schiatti机圆边的磨削。
规格 Technical Specification Size:(mm)

编号 Code	外径 D	孔径 H	玻璃厚度 G.T	粒度 G
A3-2	175	25	3,4,5,6,8,10	80,150,180,240

Application: It is used for pencil edge on Schiatti machine, keyway size 4 x 8mm

杯形金刚轮 Diamond Cup Wheel



170623 100# Q5

■ 用于斜边机的磨削
规格 Technical Specification Size:(mm)

编号 Code	外径 D	孔径 H	工作层尺寸 Actual Work Rim Size	粒度 G
A2-2	150	12,22,25,50	5×10	100,140,180,240

Application: It is used for beveling machine & for SB-10 shape beveling machine.

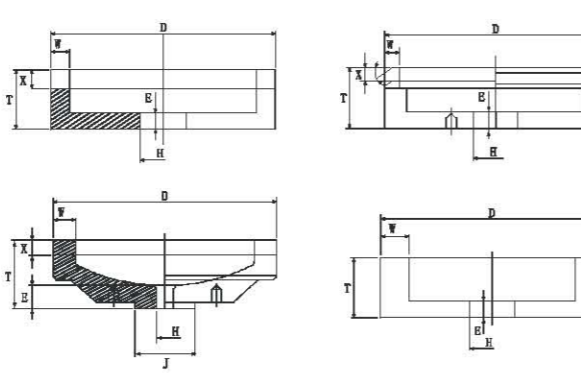

磨轮参数定义

D 磨轮外径	D Wheel diameter
E 磨轮内孔处厚度	E Hub thickness at the bore
H 磨轮内孔	H Bore diameter
J 底座台阶直径	J Hub diameter
T 磨轮总高	T Total wheel height
V 斜边角度	V Bevel angle
W 边部	W Diamond section width
X 金刚石断面厚度	X Diamond section depth

Q5 圆边 / 直边金刚轮 Standard Diamond Profile Wheel PE / FA (For China Market)



■ 用于直线圆/直边及异形圆/直边的磨削
规格 Technical Specification Size:(mm)

编号 Code	外径 D	孔径 H	玻璃厚度 G.T	粒度 G
A3-3	150,175,200	22	3,4,5,6,8,10,12,15,19	80,150,180,240

Application: It is used for pencil edge / flat with arrison shape machine.

Q6 优质圆边/直边金刚轮 Upgraded Diamond Profile Wheel PE / FA



■ 用于直线圆/直边及异形机圆直边的磨削。
规格 Technical Specification Size:(mm)

编号 Code	外径 D	孔径 H	玻璃厚度 G.T	粒度 G
A3-4	150,175,200	22	2,3,4,5,6,8,10,12,15,19	80,150,180,240

Application: Adopt Imported raw material making wheels sharper and more wear-resistant,used for pencil edge / flat with arris on Shape Machine.

注：特殊尺寸可按要求订做。Remarks:Different specifications are available if request.

注：特殊尺寸可按要求订做。Remarks:Different specifications are available if request.

1
金刚石磨轮系列

1
金刚石磨轮系列

Q6优质圆边 / 直边金刚轮 Upgraded Diamond Profile Wheel PE / FA (General Style)



■ 用于直线圆/直边及异形机圆/直边的磨削
规格 Technical Specification Size:(mm)

编号 Code	外径 D	孔径 H	玻璃厚度 G.T	粒度 G
A3-5	80, 100	22	2, 3, 4, 5, 6, 8, 10, 12, 15, 19	80, 150, 180, 240

Application: Adopt imported raw material making wheels sharper and more wear-resistant, used for pencil edge / flat with aris on Shape Machine.

Q4圆边 / 直边金刚轮 Standard Diamond Profile Wheel PE / FA



■ 用于异形机圆/直边的磨削
规格 Technical Specification Size:(mm)

编号 Code	外径 D	孔径 H	玻璃厚度 G.T	粒度 G
A3-6	25	12	3, 4, 5, 6, 8, 10, 12, 15, 19	80, 150, 180, 240
	35, 50	22	3, 4, 5, 6, 8, 10, 12, 15, 19	80, 150, 180, 240

Application: It is used for pencil edge / flat with aris.

直线圆边机金刚轮 Profile Diamond Wheel for Round Edge Machine



■ 用于直线圆边机的磨削
规格 Technical Specification Size:(mm)

编号 Code	外径 D	孔径 H	玻璃厚度 G.T	粒度 G
A4-1	175, 200	90	3, 2, 3, 8, 4, 5, 6, 8, 10	120, 150, 180, 240

Application: 1.) Used on vertical/horizontal round glass edge machine
2.) Edge shape: PE/FA
3.) Fixing hole: 80mm

直线圆边机金刚轮 Profile Diamond Wheel for Round Edge Machine



■ 用于直线圆边机的磨削
规格 Technical Specification Size:(mm)

编号 Code	外径 D	孔径 H	玻璃厚度 G.T	粒度 G
A4-2	200	50	4, 5, 6, 8, 10	80, 150, 180, 240

Application: 1.) Used on vertical/horizontal round glass edge machine
2.) Edge shape: PE, FA
3.) Fixing hole: 50mm

Q6优质圆边 / 直边金刚轮 (铜边) Upgraded Diamond Profile Wheel PE / FA (Brass Rim)



■ 用于直线圆/直边及异形机圆/直边的磨削
规格 Technical Specification Size:(mm)

编号 Code	外径 D	孔径 H	玻璃厚度 G.T	粒度 G
A3-7	150, 175, 200	22	2, 3, 4, 5, 6, 8, 10, 12, 15, 19	80, 150, 180, 240

Application: Adopt imported raw material making wheels sharper and more wear-resistant, used for pencil edge / flat with aris on Round Edger or Shape Machine.

Q6优质圆边 / 直边金刚轮 (铜边) Upgraded Diamond Profile Wheel PE / FA (Brass Rim)



■ 用于异形机圆直边的磨削
规格 Technical Specification Size:(mm)

编号 Code	外径 D	孔径 H	玻璃厚度 G.T	粒度 G
A3-8	80, 100	22	2, 3, 4, 5, 6, 8, 10, 12, 15, 19	80, 150, 180, 240

Application: Adopt imported raw material making wheels sharper and more wear-resistant, used for pencil edge / flat with aris on Shape Machine.

汽车玻璃金刚轮 (MR. VRP 槽形) Profile Diamond Wheel for Auto Glass (MR/VRP Groove)



■ 用于坂东预处理线(第一代)
规格 Technical Specification Size:(mm)

编号 Code	外径 D	孔径 H	玻璃厚度 T	粒度 G
A4-3	100, 150	30	2.1, 2.5, 3, 3.2, 3.5, 4.5, 6	150, 180, 200, 240

Application: Use on Bando preprocessing Line(1st Version)

汽车玻璃金刚轮 (MR. VRP 槽形) Profile Diamond Wheel for Auto Glass (MR/VRP Groove)



■ 用于百超.坂东机预处理线
规格 Technical Specification Size:(mm)

编号 Code	外径 D	孔径 H	玻璃厚度 T	粒度 G
A4-4	100, 150	22	2.1, 2.5, 3, 3.2, 3.5, 4.5, 6	150, 180, 200, 240

Application: Used on Bystronic and Bando Preprocessing Line

注: 特殊尺寸可按要求订做。Remarks: Different specifications are available if request.

注: 特殊尺寸可按要求订做。Remarks: Different specifications are available if request.

平行金刚轮 Standard Diamond Flat Edge Wheel (General Style)

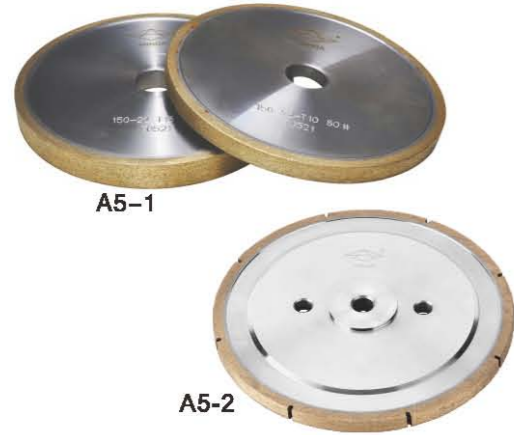

■ 用于直线圆/直边及异形机的磨削
规格 Technical Specification Size:(mm)

编号 Code	外径 D	孔径 H	磨轮厚度 T	粒度 G
A5-1	100,150,175,200	22	10,15,20,25,30	80,150,180,240
A5-2	175,200	12	定做 customized	80,150,180,240

FE style, this is used for round edge machine and shape machine.

45° 斜坡金刚轮 45° Miter Diamond Wheel



■ 用鸭嘴边金刚轮前,可以减少鸭嘴轮的损耗
规格 Technical Specification Size:(mm)

编号 Code	外径 D	孔径 H	玻璃厚度 G.T	粒度 G
A6-1	100,150	22	8,10,12,15,19	80,150,180,240

Application: It is used for shape edge before OG wheel and can reduce the waste of OG wheel.

三鸭嘴金刚轮 Standard 3-OG Diamond Wheel



■ 用于三鸭嘴边的磨削
规格 Technical Specification Size:(mm)

编号 Code	外径 D	孔径 H	磨轮厚度 G.T	粒度 G
A6-4	100,150	22	10,12,15,19	80,240

Application: It is used for rough grinding of 3-OG shape.

长鸭嘴金刚轮 Standard Long OG Diamond Wheel



■ 用于长鸭嘴边的磨削
规格 Technical Specification Size:(mm)

编号 Code	外径 D	孔径 H	磨轮厚度 G.T	粒度 G
A6-5	100,150	22	8,10,12	80,240

Application: It is used for rough grinding of longer OG shape.

单鸭嘴金刚轮 Standard OG Diamond Wheel



■ 用于单鸭嘴边的磨削
规格 Technical Specification Size:(mm)

编号 Code	外径 D	孔径 H	玻璃厚度 G.T	粒度 G
A6-2	100,150,175	22	8,10,12,15,19	80,240

Application: It is used for rough grinding of OG shape.

双鸭嘴金刚轮 Standard 2-OG Diamond Wheel



■ 用于双鸭嘴边的磨削
规格 Technical Specification Size:(mm)

编号 Code	外径 D	孔径 H	玻璃厚度 G.T	粒度 G
A6-3	100,150	22	8,10,12,15,19	80,240

Application: It is used for rough grinding of 2-OG shape.

30° 长鸭嘴金刚轮 30° Long OG Diamond Wheel



■ 用于异形机
规格 Technical Specification Size:(mm)

编号 Code	外径 D	孔径 H	玻璃厚度 G.T	粒度 G
A6-6	100,150	22	8,10,12	80,150,180,240

Application: It is used for shape machine.

1/4 圆边金刚轮 Standard Waterfall Diamond Wheel (General Style)



■ 用于异形机
规格 Technical Specification Size:(mm)

编号 Code	外径 D	孔径 H	玻璃厚度 G.T	粒度 G
A6-7	100,150	22	8,10,12,15,19	80,150,180,240

Application: It is used for shape machine.

注: 特殊尺寸可按要求订做。Remarks: Different specifications are available if request.

注: 特殊尺寸可按要求订做。Remarks: Different specifications are available if request.

特殊1/4圆边金刚轮 Standard Special Waterfall Diamond Wheel



■ 用于异形机

规格 Technical Specification Size:(mm)

编号 Code	外径 D	孔径 H	玻璃厚度 G.T	粒度 G
A6-8	100,150	22	8,10,12,15,19	80,150,180,240

Application: It is used for shape machine.

周齿金刚轮 Standard Segmented Diamond Profile Wheel(Flat Edge)



■ 用于 CNC 加工中心的粗磨

规格 Technical Specification Size:(mm)

编号 Code	外径 D	孔径 H	玻璃厚度 G.T	粒度 G
A7-1	100,150,200	22	6,8,10,12,15,19	80,240

Application: It is used for rough grinding on CNC Machine.

CNC 金刚轮 CNC Diamond Profile Wheel (General Style)



■ 用于异形机

规格 Technical Specification Size:(mm)

编号 Code	外径 D	孔径 H	玻璃厚度 G.T	粒度 G
A7-4	100,120,150	22	3, 4, 5, 6, 8, 10,12,15,19	150,180,240

Application: CNC diamond wheel with inner cooling system, which is sharper, last for long and can work at a very high speed.

刻花金刚轮 Diamond V-Engraving Wheel(General Style)



■ 用于CNC加工中心粗磨

规格 Technical Specification Size:(mm)

编号 Code	外径 D	孔径 H	刻槽宽度 Groove Width	磨轮角度 V-angle	粒度 G
A8-1	100,150,200	22	6,8,10	V90,V127, V152,V156, V160,V165	80,120,150, 180,240

Application: It is used for CNC Engraving Machine.

特殊周齿金刚轮 Special Segmented Diamond Profile Flat Edge Wheel



■ 用于 CNC 加工中心粗磨

规格 Technical Specification Size:(mm)

编号 Code	外径 D	孔径 H	磨轮厚度 T	粒度 G
A7-2	定做 customized	22	定做 customized	80,150

Application: It is used for rough grinding on CNC Machine.

45° 周齿斜坡轮 Segmented 45° Miter Diamond Wheel



■ 用于 CNC 加工中心粗磨

规格 Technical Specification Size:(mm)

编号 Code	外径 D	孔径 H	磨轮厚度 T	粒度 G
A7-3	100	22	定做 customized	80

Application: It is used for rough grinding on CNC Machine.

V 形槽金刚轮 Diamond V-groove Wheel for Chamfering



■ 用于玻璃边的磨削 (一个轮可磨三种厚度玻璃)

规格 Technical Specification Size:(mm)

编号 Code	外径 D	孔径 H	玻璃厚度 G.T	粒度 G
A9-1	150	22	3, 4, 5, 6	80,150, 180,240

Application: It's use for chamfering to 4,5,6 mm glass on one wheel.

多线槽金刚轮 Standard Multi Grooves Diamond Profile Wheel PE / FA



■ 用于直线圆 / 直边及异形机圆直边的磨削

规格 Technical Specification Size:(mm)

编号 Code	外径 D	孔径 H	玻璃厚度 G.T	粒度 G
A9-2	150	100,150, 175,200	3, 4, 5, 6	80,150, 180,240

Application: It is used for pencil edge / flat with arris.

注: 特殊尺寸可按要求订做。Remarks:Different specifications are available if request.

注: 特殊尺寸可按要求订做。Remarks:Different specifications are available if request.

翌东四边磨金刚轮 Diamond Wheel for ZHAO DONG Four Sides Edger



■ 用于四边磨边机的磨削
规格 Technical Specification Size:(mm)

编号 Code	外径 D	孔径 H	工作层尺寸 Actual work Rim Size	粒度 G
A10-1	80	30	10x10	240

Application: It's used for automatic horizontal glass straight line four sides edger.

亿海四边磨金刚轮 Diamond Wheel for Suntech Four Sides Edger



■ 用于四边磨边机的磨削
规格 Technical Specification Size:(mm)

编号 Code	外径 D	孔径 H	磨轮厚度 T	粒度 G
A10-2	150	10	22	320

Application: It's used for automatic horizontal glass straight line four sides edger.

高力威四边磨金刚轮 Diamond Wheel for Golive Four Sides Edger



■ 用于四边磨边机的磨削
规格 Technical Specification Size:(mm)

编号 Code	外径 D	孔径 H	工作层宽度 Work Rim Width	粒度 G
A10-3	160	10/20	10	240,320

Application: It's used for automatic horizontal glass straight line four sides edger.

特能四边磨金刚轮/树脂轮 Diamond Wheel / Resin Wheel for Tenon Four Sides Edger



■ 用于四边磨边机的磨削
规格 Technical Specification Size:(mm)

编号 Code	外径 D	孔径 H	工作层宽度 Work Rim Width	粒度 G
A10-4	160	40	10x15	200

Application: It's used for automatic horizontal glass straight line four sides edger.

特能四边磨树脂轮 Diamond Wheel for Tenon Four Sides Edger



■ 用于四边磨边机的磨削
规格 Technical Specification Size:(mm)

编号 Code	外径 D	孔径 H	工作层尺寸 Actual Work Rim Size	粒度 G
A10-5	160	68	40x10	200

Application: It's used for automatic horizontal glass straight line four sides edger.

精工四边磨树脂轮 Diamond Wheel for Precision Four Sides Edger



■ 用于四边磨边机的磨削
规格 Technical Specification Size:(mm)

编号 Code	外径 D	孔径 H	工作层尺寸 Actual Work Rim Size	粒度 G
A10-6	160	32	10x20	200

Application: It's used for automatic horizontal glass straight line four sides edger.

注：特殊尺寸可按需求订做。Remarks: Different specifications are available if request.



树脂轮系列

RESIN WHEEL SERIES

- 斜边机树脂轮 ■ 双边机树脂轮 ■
- 异形斜边树脂轮 ■ 直边机树脂轮 ■

杯形树脂轮 Resin Cup Wheel (Red Rim)



■ 用于直边机、双边机

规格 Technical Specification Size:(mm)

编号 Code	外径 D	孔径 H	工作层尺寸 Actual Work Rim Size	粒度 G
B1-1	175	12,22,50	10 × 10, 15 × 10, 20 × 10	180, 240, 320
	150	12,22,25,50	10 × 10, 15 × 10, 20 × 10	180, 240, 320
	130	12,22,50	10 × 10, 15 × 10, 20 × 10	180, 240, 320
	100	12,50	10 × 10	180, 240, 320

Application: It is used for edging machine and double edging machine.

杯形树脂轮 Resin Cup Wheel (Green Rim)



■ 用于直边机、双边机

规格 Technical Specification Size:(mm)

编号 Code	外径 D	孔径 H	工作层尺寸 Actual Work Rim Size	粒度 G
B1-2	175	12,22,50	10 × 10, 15 × 10, 20 × 10	180, 240, 320
	150	12,22,25,50	10 × 10, 15 × 10, 20 × 10	180, 240, 320
	130	12,22,50	10 × 10, 15 × 10, 20 × 10	180, 240, 320
	100	12,50	10 × 10	180, 240, 320

Application: It is used for edging machine and double edging machine.

碗形带齿树脂轮 Bowl Resin Wheel (Turbo)



■ 用于斜边机

规格 Technical Specification Size:(mm)

编号 Code	外径 D	孔径 H	工作层尺寸 Actual Work Rim Size	粒度 G
B2-3	150	12,22,50	16 × 10	3#, 4#, 5#, 6#, 7#

Application: It is used for beveling machine.

三色轮 Three-band Resin Wheel (Aluminum Body)



■ 用于异形斜边机

规格 Technical Specification Size:(mm)

编号 Code	外径 D	孔径 H	工作层尺寸 Actual Work Rim Size	粒度 G
B3-1	150	12,22	15 × 10	粗, 中, 细

Application: It is used for shape-beveling machine, intergrating coarse, medium, fine grits in one wheel.

碗形树脂轮 Resin Wheel (Bowl Shape)



■ 用于斜边机

规格 Technical Specification Size:(mm)

编号 Code	外径 D	孔径 H	工作层尺寸 Actual Work Rim Size	粒度 G
B2-1	150	12,22,25,50	15 × 12	3#, 4#, 5#, 6#, 7#

Application: It is used on beveling machine, for mirror beveling

杯形带齿树脂轮 Resin Cup Wheel (turbo)



■ 用于斜边机

规格 Technical Specification Size:(mm)

编号 Code	外径 D	孔径 H	工作层尺寸 Actual Work Rim Size	粒度 G
B2-2	150	12,22,25,50	20 × 10	3#, 4#, 5#, 6#, 7#

Application: It is used on beveling machine, for architectural glass bevelling, with high efficiency

三色轮 Three-band Resin Wheel



■ 用于异形斜边机

规格 Technical Specification Size:(mm)

编号 Code	外径 D	孔径 H	工作层尺寸 Actual Work Rim Size	粒度 G
B3-2	150	12,22	15 × 10	粗, 中, 细

Application: It is used for shape-beveling machine, intergrating coarse, medium, fine grits in one wheel.

异形斜边树脂轮 Shape-beveling Resin Wheel



■ 用于异形斜边机

规格 Technical Specification Size:(mm)

编号 Code	外径 D	孔径 H	工作层尺寸 Actual Work Rim Size	粒度 G
B3-3	150	12,22	15 × 10	120, 180, 240

Application: It is used for shape-beveling machine.

注: 特殊尺寸可按要求订做。Remarks: Different specifications are available if request.

注: 特殊尺寸可按要求订做。Remarks: Different specifications are available if request.



抛光轮系列 (一)

POLISHING WHEEL SERIES (1)

- 10S抛光轮
- X-5000精抛轮
- CE-3精抛轮



10S抛光轮 Standard 10S Polishing Wheel



规格 Technical Specification Size:(mm)

编号 Code	外径 D	孔径 H	磨轮厚度 T	粒度 G
C1-1	170	70	40	40,60, 80, 120
	150	22, 50, 68, 70	40, 35, 30	40,60, 80, 120
	125,130	22, 50, 60	35	40,60, 80
	100	60	35	40,60, 80

优质10S抛光轮 Upgraded 10S Polishing Wheel



规格 Technical Specification Size:(mm)

编号 Code	外径 D	孔径 H	磨轮厚度 T	粒度 G
C1-2	170	70	40	40,60, 80, 120
	150	22, 50, 68, 70	40, 35, 30	40,60, 80, 120
	125,130	22, 50, 60	35	40,60, 80
	100	60	35	40,60, 80

带座10S抛光轮 Standard 10S Polishing with Base



规格 Technical Specification Size:(mm)

编号 Code	外径 D	孔径 H	磨轮厚度 T	粒度 G
C1-3	150	12, 22, 50	40	40,60, 80, 120
	125,130	12, 22, 50	35	40,60, 80

优质带座10S抛光轮 Upgraded 10S Polishing with Base



规格 Technical Specification Size:(mm)

编号 Code	外径 D	孔径 H	磨轮厚度 T	粒度 G
C1-4	150	12, 22, 50	40	40,60, 80, 120
	125, 130	12, 22, 50	35	40,80, 80

注：特殊尺寸可按要求订做。Remarks: Different specifications are available if request.

窄边10S抛光轮 Standard 10S Polishing with Rim 13mm

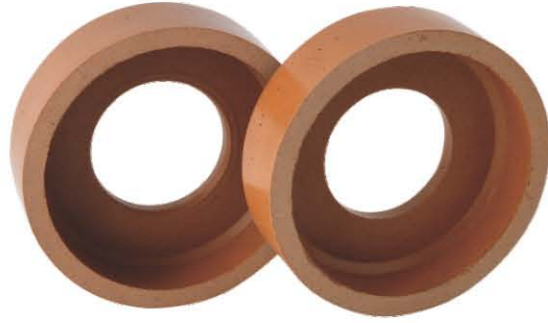

规格 Technical Specification Size:(mm)

编号 Code	外径 D	孔径 H	磨轮厚度 T	环宽 Rim	粒度 G
C1-5	150	70	40	13	40,60

优质窄边10S抛光轮 Upgraded 10S Polishing with Rim 13mm



规格 Technical Specification Size:(mm)

编号 Code	外径 D	孔径 H	磨轮厚度 T	环宽 Rim	粒度 G
C1-6	150	70	40	13	40,60

CE-3 精抛轮 CE-3 Polishing



规格 Technical Specification Size:(mm)

编号 Code	外径 D	孔径 H	磨轮厚度 T
C2-1	170	70	40
	150	70	40

X5000 精抛轮 X5000 Cerium Wheel



规格 Technical Specification Size:(mm)

编号 Code	外径 D	孔径 H	磨轮厚度 T
C2-2	150	22,50, 68, 70	40, 30

9R 抛光轮 Standard 9R Polishing Wheel



规格 Technical Specification Size:(mm)

编号 Code	外径 D	孔径 H	磨轮厚度 T	粒度 G
C1-7	150	70	40	40,60,80

优质9R 抛光轮 Upgraded 9R Polishing Wheel



规格 Technical Specification Size:(mm)

编号 Code	外径 D	孔径 H	磨轮厚度 T	粒度 G
C1-8	150	70	40	40,60,80

CX09 Cx09 Polishing Wheel



规格 Technical Specification Size:(mm)

编号 Code	外径 D	孔径 H	磨轮厚度 T
C2-3	150	70	30

玻璃效果图



注：特殊尺寸可按要求订做。Remarks:Different specifications are available if request.

注：特殊尺寸可按要求订做。Remarks:Different specifications are available if request.

杯形 BK 抛光轮 BK Cup Polishing Wheel



规格 Technical Specification Size:(mm)

编号 Code	外径 D	孔径 H	磨轮厚度 T	粒度 G
C3-1	150	22, 50, 68, 70	40	40, 60, 80, 120
	130	22, 50, 60	35	40, 60

带座 BK 抛光轮 BK Cup Polishing Wheel with Base



规格 Technical Specification Size:(mm)

编号 Code	外径 D	孔径 H	磨轮厚度 T	粒度 G
C3-2	150	50	40	40, 60, 80, 120

平行绿BD抛光轮 Green BD Polishing Wheel



规格 Technical Specification Size:(mm)

编号 Code	外径 D	孔径 H	磨轮厚度 T
C4-3	100, 150, 200	22	15, 20, 25, 30

CNC BD 轮 BD Polishing Wheel for CNC Machine



规格 Technical Specification Size:(mm)

编号 Code	外径 D	孔径 H	磨轮厚度 T
C4-4	100, 120	22	15, 20, 25, 30

Application: BD polishing wheel with inner cooling system, which is special for CNC Machine.

平行 BK 抛光轮 BK Peripheral Polishing Wheel



规格 Technical Specification Size:(mm)

编号 Code	外径 D	孔径 H	磨轮厚度 T	粒度 G
C3-3	100, 150, 200	22	15, 20, 25, 30	46, 60, 80, 120, 180, 240

圆边机 BK 抛光轮 BK Peripheral Polishing Wheel for Round Edger



规格 Technical Specification Size:(mm)

编号 Code	外径 D	孔径 H	磨轮厚度 T	粒度 G
C3-4	200	90	15, 20, 25, 30	46, 60, 80, 120, 180, 240

圆边机 BD 抛光轮 BD Polishing Wheel (Soft & Hard)



规格 Technical Specification Size:(mm)

编号 Code	外径 D	孔径 H	磨轮厚度 T
C4-5	200	90	15, 20, 25, 30

特殊 BD 抛光轮 Small BD Polishing Wheel



规格 Technical Specification Size:(mm)

编号 Code	外径 D	孔径 H	磨轮厚度 T
C4-6	25, 30	12	25, 30, 35
	50	22	15, 20, 25, 30

平行硬 BD 抛光轮 BD Polishing Wheel(Hard)



规格 Technical Specification Size:(mm)

编号 Code	外径 D	孔径 H	磨轮厚度 T
C4-1	100, 150, 200	22	15, 20, 25, 30

平行软BD抛光轮 BD Polishing Wheel (Soft)



规格 Technical Specification Size:(mm)

编号 Code	外径 D	孔径 H	磨轮厚度 T
C4-2	100, 150, 200	22	15, 20, 25, 30

带座 BD 抛光轮 BD Polishing with Base



规格 Technical Specification Size:(mm)

编号 Code	外径 D	孔径 H	磨轮厚度 T
C4-7	A 150, 130, 125	12, 25, 50	40
	B 150, 130, 125	12, 25, 50	40

刻花 BD 轮 BD V-Engraving Wheel



规格 Technical Specification Size:(mm)

编号 Code	外径 D	孔径 H	磨轮厚度 T
C4-8	140, 150	22	5, 6, 8, 10, 12
	160, 200	22, 40, 50, 90	5, 6, 8, 10, 12

注：特殊尺寸可按要求订做。Remarks:Different specifications are available if request.

注：特殊尺寸可按要求订做。Remarks:Different specifications are available if request.



抛光轮系列 (二)

POLISHING WHEEL SERIES (2)

- BD 抛光轮
- BK 抛光轮
- 羊毛轮
- 石头轮

LOW-E 玻璃除膜轮系列

LOW-E GLASS COATING DELETION WHEEL SERIES

- 干除膜轮
- 湿除膜轮
- 特殊规格除膜轮



优质蓝标羊毛轮 Spiral Felt Wheel (Standard)



规格 Technical Specification Size:(mm)

编号 Code	外径 D	孔径 H	磨轮厚度 T
C5-1	150	70,105	25, 35, 40
	185	115	25, 35, 40

优质绿标羊毛轮 Spiral Felt Wheel (Upgraded)



规格 Technical Specification Size:(mm)

编号 Code	外径 D	孔径 H	磨轮厚度 T
C5-2	150	70,105	25, 35, 40
	185	115	25, 35, 40

进口材料羊毛轮 Spiral Felt(Imported Raw Material)



规格 Technical Specification Size:(mm)

编号 Code	外径 D	孔径 H	磨轮厚度 T
C5-3	150	70,105	25, 35, 40
	185	115	25, 35, 40

普通羊毛轮 Spiral Felt Wheel



规格 Technical Specification Size:(mm)

编号 Code	外径 D	孔径 H	磨轮厚度 T
C5-4	150	70,105	25, 35, 40
	185	115	25, 35, 40

氧化铈羊毛轮 Spiral Felt Wheel with Cerium Oxide



规格 Technical Specification Size:(mm)

编号 Code	外径 D	孔径 H	磨轮厚度 T
C5-5	150	70, 105	25, 35, 40

澳毛纯羊毛轮 Pure Wool Felt



规格 Technical Specification Size:(mm)

编号 Code	款式 Type	外径 D	孔径 H	磨轮厚度 T
C5-6	A	150, 200, 250, 300	22	25, 30, 35, 40
	B	150	70	40

注：特殊尺寸可按要求订做。Remarks: Different specifications are available if request.

杯形石头轮 Stone Wheel

规格 Technical Specification Size:(mm)			
编号 Code	外径 D	孔径 H	磨轮厚度 T
C6-1	150	12, 22, 50, 70	40
	130	12, 22, 50, 70	35, 40

石头轮 Stone Wheel

规格 Technical Specification Size:(mm)			
编号 Code	外径 D	孔径 H	磨轮厚度 T
C6-2	100	12, 22, 50	40

石头轮功能介绍

石头轮主要用于玻璃倒角用，前不需要用金刚轮，后面也不需要抛光轮，可以单独倒角，磨出来的效果非常光亮。因此，此产品可以大大节省公司生产成本。石头轮一经问世就收到广大企业的青睐。平行石头轮主要用于玻璃倒安全角，代替倒角BD轮，耐磨度更高。

Stone Wheel

Stone wheel series are mainly used for making and polishing arris as well , no need diamond wheel before it , only one wheel can obtain excellent performance on the arris . It' s well welcomed by glass processing factories because it can save much cost . The periheral one has longer life than BD polishing , which is mainly used for making and polishing safety arris of glass , so many factories always use it in place of BD polishing.

石头轮工作示意图

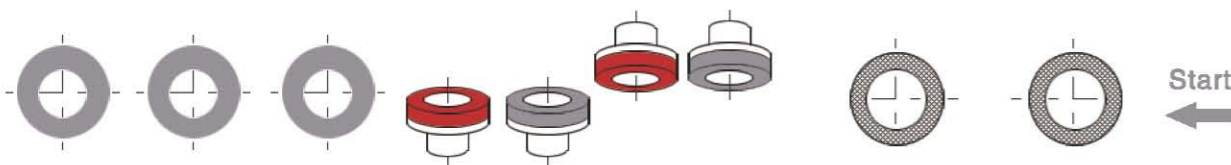

注：特殊尺寸可按要求订做。Remarks:Different specifications are available if request.

进口10S抛光轮 R.B.M. 10S Polishing Wheel

规格 Technical Specification Size:(mm)				
编号 Code	外径 D	孔径 H	磨轮厚度 T	粒度 G
C7-1	170	70	40	40, 60
	150	70	40, 35, 30	40, 60, 80, 120
	130	60	35	40, 60, 80

进口9R抛光轮 R.B.M. 9R Polishing Wheel

规格 Technical Specification Size:(mm)				
编号 Code	外径 D	孔径 H	磨轮厚度 T	粒度 G
C7-2	150	70	40	40, 60, 80
	130	60	35	40, 60

进口9RS抛光轮 R.B.M. 9RS Polishing Wheel

规格 Technical Specification Size:(mm)				
编号 Code	外径 D	孔径 H	磨轮厚度 T	粒度 G
C7-3	150	50, 70	40	40, 60

进口窄边10S抛光轮 R.B.M. 10S Polishing Wheel with Rim 13mm

规格 Technical Specification Size:(mm)				
编号 Code	外径 D	孔径 H	磨轮厚度 T	粒度 G
C7-4	150	70	40	40, 60

进口开齿10S抛光轮 R.B.M. 10S Polishing Wheel Segmented

规格 Technical Specification Size:(mm)				
编号 Code	外径 D	孔径 H	磨轮厚度 T	粒度 G
C7-5	150	50, 70	40	40, 60

进口开齿9RS抛光轮 R.B.M. 9RS Polishing Wheel Segmented

规格 Technical Specification Size:(mm)				
编号 Code	外径 D	孔径 H	磨轮厚度 T	粒度 G
C7-6	150	50, 70	40	40, 60

注：特殊尺寸可按要求订做。Remarks:Different specifications are available if request.

5

进口抛光轮系列

进口X081抛光轮 R.B.M. X081 Polishing Wheel



规格 Technical Specification Size:(mm)

编号 Code	外径 D	孔径 H	磨轮厚度 T
C7-7	150	70	30

进口X09抛光轮 R.B.M. X09 Polishing Wheel



规格 Technical Specification Size:(mm)

编号 Code	外径 D	孔径 H	磨轮厚度 T
C7-8	150	70	40, 30

进口石头轮 R.B.M. MB3 Polishing Wheel



规格 Technical Specification Size:(mm)

编号 Code	外径 D	孔径 H	磨轮厚度 T
C7-9	150	70, 12	40
	130	60, 12	35

进口石头轮 R.B.M. MB3 Polishing Wheel



规格 Technical Specification Size:(mm)

编号 Code	外径 D	孔径 H	磨轮厚度 T
C7-10	100	12	45

进口卷状羊毛轮 Imported Spiral Felt Wheel



规格 Technical Specification Size:(mm)

编号 Code	外径 D	孔径 H	磨轮厚度 T
C7-11	150	70	35
	150	105	35

进口高密纯羊毛轮 Imported Pure Wool Felt Wheel



规格 Technical Specification Size:(mm)

编号 Code	外径 D	孔径 H	磨轮厚度 T
C7-12	150	70	40
	200, 150	22	40

注：特殊尺寸可按要求订做。Remarks: Different specifications are available if request.

进口异形斜边 BK 抛光轮 Imported BK Polishing Wheel for Shape Beveling Machine



规格 Technical Specification Size:(mm)

编号 Code	外径 D	孔径 H	磨轮厚度 T	粒度 G
C7-13	150	100	25	40,60

进口BK抛光轮 Artifex BK Polishing Wheel



规格 Technical Specification Size:(mm)

编号 Code	外径 D	孔径 H	磨轮厚度 T	粒度 G
C7-14	150	70	40	46,60
	130	60	35	46,60

进口 AO 轮 Artifex AO Polishing Wheel



规格 Technical Specification Size:(mm)

编号 Code	外径 D	孔径 H	磨轮厚度 T	粒度 G
C7-15	150	50, 70	40	40,60

进口 CE-3 Artifex CE-3 Polishing Wheel



规格 Technical Specification Size:(mm)

编号 Code	外径 D	孔径 H	磨轮厚度 T
C7-16	170	70	40
	150	70	40

注：特殊尺寸可按要求订做。Remarks: Different specifications are available if request.

5

进口抛光轮系列

LOW-E 玻璃除膜轮(单银、双银) Coating Deletion Wheel (Dry Use)



规格 Technical Specification Size:(mm)

编号 Code	外径 D	孔径 H	磨轮厚度 T
D-1	200	76.2	8,10,12,15,20,25,30

LOW-E 玻璃除膜轮(单银、双银、三银) Coating Deletion Wheel (Dry Use)



规格 Technical Specification Size:(mm)

编号 Code	外径 D	孔径 H	磨轮厚度 T
D-2	200	76.2	8,10,12,15,20,25,30

湿除膜轮 Coating Deletion Wheel (Wet Use)



规格 Technical Specification Size:(mm)

编号 Code	外径 D	孔径 H	磨轮厚度 T
D-3	150,200	22,50,76.2	8,10,12,15,20,25

孔位除膜轮 Coating Deletion Wheel (Dry Use)



规格 Technical Specification Size:(mm)

编号 Code	外径 D	孔径 H	磨轮厚度 T
D-4	50,80,65	6	6,8,10,15,20,25,30

注：特殊尺寸可按要求订做。Remarks: Different specifications are available if request.



玻璃钻头系列

DIAMOND TOOLS SERIES

- 其它定制带柄磨头
- 电镀钻、倒角器
- 水嘴、接头
- 白刚玉
- 整体钻、整体倒角器
- 烧结钻、烧结倒角器
- CNC铣刀、内孔磨头
- 倒角套

金刚石钻头 Diamond Drill



编号 Code	长度 Total Height	直径 Dia
E1-1	75mm	4-150mm
	95mm	4-150mm

Remark: Belgium type Gas 1/2", steel body painted to rust resistance.

金刚石钻头 Diamond Drill Special for 2-4mm Glass



编号 Code	长度 Total Height	直径 Dia
E1-2	75mm	4-100mm
	95mm	4-100mm

Remark: Belgium type Gas 1/2", steel body, wall thickness 0.6mm, special for 2-4mm glass

倒角套 Countersink



编号 Code	壁厚 Wall Thickness	直径 Dia
E2-1	3.5mm	5-130mm
	5mm	5-130mm

烧结倒角器 Countersink Bits (General Style)



编号 Code	直径 Dia
E2-2	0-8 to 8-80mm

CNC金刚石钻头 Diamond Drill Special for CNC Machine



编号 Code	长度 Total Height	直径 Dia
E1-3	75mm	4-45mm
	95mm	4-45mm

Remark: Belgium type Gas 1/2", steel body.

钻盘&钻片 Cricle Cutter Disc and its Cutters

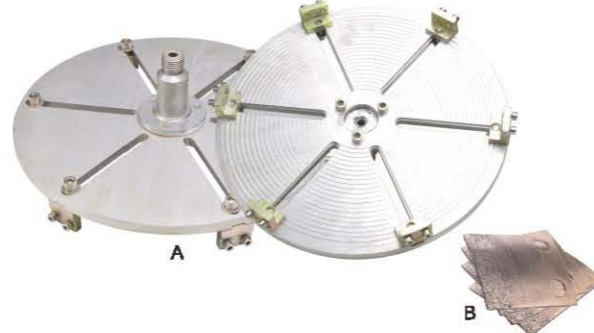

编号 Code	规格 Spec
E1-4	60-200mm, 60-250mm, 60-300mm, 60-350mm

特殊整体倒角器 Special Countersink Bits with Thread



编号 Code	长度 Total Height	直径 Dia
E2-3	定做 Customized	定做 Customized

整体倒角器 Countersink Bits with Thread (General Style)



编号 Code	长度 Total Height	直径 Dia
E2-4	75mm	0-16 to 0-80mm
	95mm	0-16 to 0-80mm

Remark: Belgium Type Gas 1/2", with inner cooling water flows

特殊金刚石钻头 Special Diamond Drill



编号 Code	长度 Total Height	直径 Dia
E1-5	定做 Customized	定做 Customized

Remark: Belgium type Gas 1/2", steel body, it is used for Granite, Marble, Rock, Ceramic, Glass Tile ect

烧结钻 Diamond Drill



编号 Code	直径 Dia
E1-6	4-150mm

Remark: Cone Shank & Straight Shank

带柄金刚石磨头 Straight Shank FE Diamond Grinding Bit



编号 Code	直径 Dia
E2-5	定做 Customized

Remark: FE style & straight shank

带柄金刚石磨头 Straight Shank FA Diamond Grinding Bit



编号 Code	直径 Dia
E2-6	定做 Customized

Remark: FE style & straight shank

注: 特殊尺寸可按要求定做. Remarks: Different specifications are available if request.

注: 特殊尺寸可按要求定做. Remarks: Different specifications are available if request.

7

玻璃钻头系列

钻铣磨一体铣刀 Combi Tool for Drilling+Milling+Edging



编号 Code	直径 Dia
E3-1	定做 Customized

Remark:FE style& straight shank

CNC铣刀 Router



编号 Code	款式 Type	长度 Total Height	直径 Dia	节 Segments	刀头长度 Diamond Length
E3-2	A	108	10,16	3	20
			20	4,5	
B	80	8,10,12	3		
		14,16,18	4		
		20,22	4,5		40
		24,25,26	5,6		

Remark:Belgium type Gas1/2"

电镀直柄钻头 Electroplated Straight Shank Core Drill



编号 Code	钻头直径 Dia
E5-1	3-150mm

电镀锥形磨头 Electroplated Countersink Bit



编号 Code	钻头直径 Dia
E5-2	0-15 to 0-60mm

7

玻璃钻头系列

CNC内孔磨轮 CNC Trap Wheels(General Style)



编号 Code	长度 Total Height	铣刀规格 Size of Router Part	玻璃厚度 Glass Thickness
E3-3	75	15,18,20,25	4,6,8,10,12,15,19
	95	15,18,20,25	4,6,8,10,12,15,19
	108	15,18,20,25	4,6,8,10,12,15,19

Remark:Belgium type Gas1/2", with inner cooling water flows

白刚玉、油石条 Dressing Stone

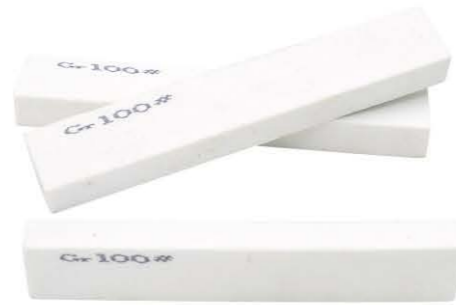

编号 Code	规格 Spec	粒度 G
E4-1	150X25X15	80,100
	120X25X15	80,100

其他规格可按要求定做 Different specification are available request.

打孔机水嘴 Water Chuck for Drilling Machine



编号 Code	规格
E5-3	

水嘴(连接直柄钻) Water Chuck for Straight Shank Drill Bit



编号 Code	规格
E5-4	

三角钻 TCT Drill Bits



编号 Code	规格 Spec
E4-2	4mm,5mm,6mm

连接头 Adapter



编号 Code	规格
E4-3	

水嘴(连接锥柄钻) Water Chuck for Cone Shank Drill Bit



编号 Code	规格
E5-5	

水嘴(连接整体钻) Water Chuck for Thread Drill Bit



编号 Code	规格
E5-6	

注：特殊尺寸可按要求定做。 Remarks: Different specifications are available if request.

注：特殊尺寸可按要求定做。 Remarks: Different specifications are available if request.

WASON推刀 WASON T-Cutter



编号 Code	规格 Spec	包装 Standard Packing
F1-1	60cm, 90cm, 120cm, 150cm, 180cm, 210cm	6 pcs/ctn

KD T型推刀 KD T-Cutter



编号 Code	规格 Spec	包装 Standard Packing
F1-2	60cm, 90cm, 120cm, 150cm, 180cm, 210cm	6 pcs/ctn

圆规刀 Circle Cutter

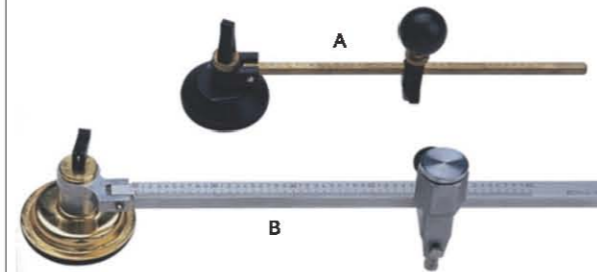

编号 Code	规格 Cutting Diameter
F2-1	60cm, 90cm, 120cm, 150cm, 180cm

椭圆刀 Oval Cutter



编号 Code	规格 Spec
F2-2	15-60cm, 22-122cm, 22-200cm

WASON

手动切割工具系列

CUTTING TOOLS

- 玻璃尺
- 玻璃刀
- T型推刀
- 椭圆刀
- 切圆台
- 圆规刀
- 玻璃钳

8

手动切割工具系列

T型推刀头 T-Cutter Head



编号
Code F2-3

推刀轮 Small Wheels for T-Cutter



编号
Code F2-4

油缸 Oil Tank with Cutter Head



编号
Code F2-5

刀头 Cutter Head



编号 Code	款式 Type
F2-6	A:切圆台刀头 For F4-2
	B:异形切圆台刀头 For F4-1
	C:椭圆刀头 For Oval Cutter
	D:圆规刀头 For Circle Cutter

WASON玻璃刀 WASON Glass Cutter



编号 Code	玻璃厚度 Cutting Thickness	包装 Pcs/Box
F2-7	A 3-12mm	10
	B 6-12mm	10

WASON玻璃刀 WASON Glass Cutter



编号 Code	玻璃厚度 Cutting Thickness	包装 Pcs/Box
F2-8	A 8-15mm	6
	B 2-6mm, 6-12mm, 12-19mm	6

L形尺 L-Ruler with Brace

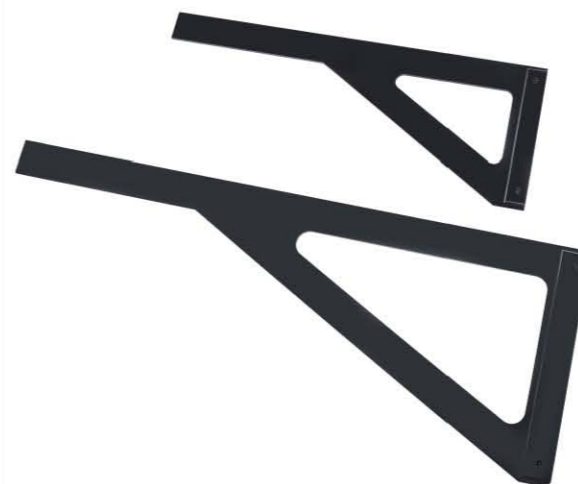

编号 Code	规格 Spec
F3-1	650mm,950mm,1250mm,1650mm,1850mm

三角尺 Triangular Ruler

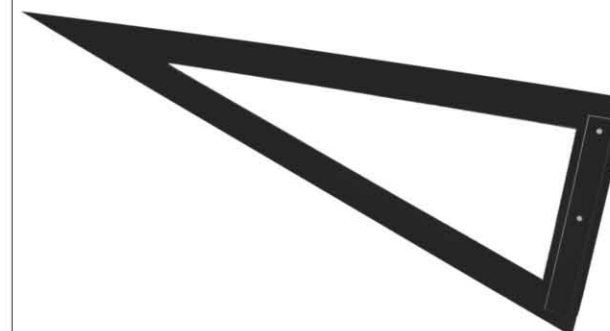

编号 Code	规格 Spec
F3-2	650mm,950mm,1250mm,1650mm,1850mm

L形尺 L-Shape Ruler



编号 Code	规格 Spec
F3-3	650mm,950mm,1250mm,1650mm,1850mm

卷尺 Tapeline



编号 Code	规格 Spec
F3-4	5m

8

手动切割工具系列

异形切圆台 Manual Shape Cutting Table



编号
Code F4-1

切圆台 Manual Round Cutting Table

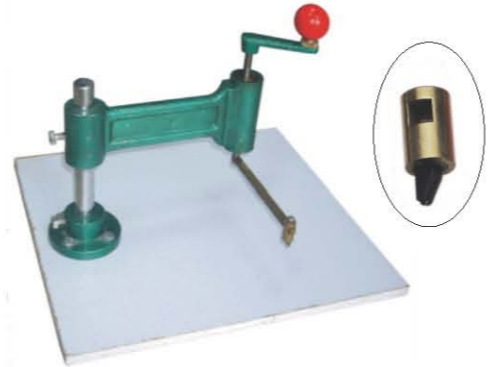

编号
Code F4-2

<table border="1"> <thead> <tr> <th>编号 Code</th> <th>规格 Spec</th> <th>玻璃厚度 T</th> </tr> </thead> <tbody> <tr> <td rowspan="3">R1 可调分边钳 Adjustable Splitting Plier</td> <td>大 Big</td> <td>5-26mm</td> </tr> <tr> <td>中 Medium</td> <td>5-15mm</td> </tr> <tr> <td>小 Small</td> <td>2-8mm</td> </tr> </tbody> </table>	编号 Code	规格 Spec	玻璃厚度 T	R1 可调分边钳 Adjustable Splitting Plier	大 Big	5-26mm	中 Medium	5-15mm	小 Small	2-8mm	<p>R2 花边钳 Plier for scallop</p>	<p>R3 大头钳 Waving Plier</p>
编号 Code	规格 Spec	玻璃厚度 T										
R1 可调分边钳 Adjustable Splitting Plier	大 Big	5-26mm										
	中 Medium	5-15mm										
	小 Small	2-8mm										
<p>R4 鹰嘴钳 Plier</p>	<p>R5 简易分边钳 Plier with three points</p>	<p>R6 平口钳 Plier with flat open</p>										
<p>R7 修边钳 Plier for edge trimming</p>	<p>R8 玻璃钳 Plier for Mosaic</p>											

吸提搬运工具系列

SUCTIONS & GLASS SHEETS CARRYING TOOLS

- 吸盘
- 搬运夹
- 吊夹
- 软木垫片

UV 灯、胶水系列

UV LAMP, UV GLUE & DETECTORS SERIES

- 无影灯
- 正反面灯 (锡面灯)
- UV 胶水
- 钢化灯

劳保防护、喷砂工具系列

SANDING BLASTING SERIES
&
LABOUR PROTECTION APPLIANCE

- 手套
- 保护膜
- 护腕
- 喷砂枪
- 防护衣
- 枪嘴



9

吸提搬运工具系列

优质黑砂吸盘 Cap Suction (Black)



编号 Code	最大吸力 Max Carrying Capacity	胶垫直径 Cup Dia	包装 Pcs/Ctn
H1-1	A	180kgs	120mm
	B	130kgs	120mm
	C	80kgs	120mm

优质黄砂吸盘 Cap Suction (Yellow)



编号 Code	最大吸力 Max Carrying Capacity	胶垫直径 Cup Dia	包装 Pcs/Ctn
H1-2	A	140kgs	120mm
	B	110kgs	120mm
	C	50kgs	120mm

大吊夹 Big Pinch Grab



编号 Code	最大吊重 Max Carrying Capacity	玻璃厚度 Glass Thickness
H2-1	1000kgs	3-28mm, 28-38mm

吸盘王 Powerful Cap Suction



编号 Code	最大吸力 Max Carrying Capacity	胶垫直径 Cup Dia	包装 Pcs/Ctn
H1-3	A	210kgs	127mm
	B	180kgs	127mm

真空泵大吸盘 Big Vacuum Suction



编号 Code	最大吸力 Max Carrying Capacity	吸皮直径 Cup Dia
H1-4	150kgs	206mm

小吊夹 Small Pinch Grab



编号 Code	最大吊重 Max Carrying Capacity	玻璃厚度 Glass Thickness
H2-2	500kgs	3-25mm

角度可调吸盘 Angle Adjustable Suction



编号 Code	最大吸力 Max Carrying Capacity	可调角度 Adjustable Angle
H1-5	35kgs	45° -270°

真空充气吸盘 Vacuum Suction



编号 Code	最大吸力 Max Carrying Capacity	吸皮直径 Cup Dia
H1-6	A	100kgs
	B	40kgs

手提玻璃夹 Hand Pinch Grab



编号 Code	最大吊重 Max Carrying Capacity	玻璃厚度 Glass Thickness
H2-3	A	250kgs
	B	100kgs

软木垫片 Cork Pads (Glue Back)



编号 Code	Code
H3-1	

9

吸提搬运工具系列



10

UV灯、胶水系列

无影灯 UV Lamp



编号 Code IA1-1

Application: For solidifying UV Glue

进口UV胶水 Loxeal UV Glue



编号 Code	重量 Weight	型号 Type
IA1-2	250ml	loxeal 30-23, 30-21
	50ml	loxeal 30-23, 30-21, 30-20

Application: Glass surface to surface applies LOXEAL 30.23
Glass to metal or Glass surface to edge applies LOXEAL 30.21 30.20

防黑边胶 Mirror Edge Seal



编号 Code IA1-3

Application: Keeping the edge of mirror silver from oxygenizing

安华UV胶水 ANHUA UV Glue



编号 Code	重量 Weight	型号 Type
IA1-4	250g	AAA-01, AAA-02

Application: Glass surface to surface applies AAA-01
Glass to metal or Glass surface to edge applies AAA-02

玻璃正反面灯 Tin Side Detector



编号 Code IA2-1

Application: To distinguish/tell the tin side of glass

铝合金正反面灯 Tin Side Detector with ALU Alloy Shell



编号 Code IA2-2

Application: To distinguish/tell the tin side of glass.

11

劳动防护、喷砂工具系列

手套 Gloves



编号 Code J1-1

简易搬运胶皮 Rubber Pad for Glass Carrying



编号 Code J1-2

护腕 Wristlet



编号 Code J1-3

棕刚砂&环保砂 Aluminum Oxide & Dustless Sand for Blasting



编号 Code	用途 Application
J2-1	A 棕刚砂 Aluminum Oxide
	B 环保砂 Dustless Sand for Blasting

套装喷砂枪 Sand Gun Kit



编号 Code J2-2

枪嘴 Nozzle



编号 Code	款式 Type	用途 Application
J2-3	A 铁枪咀 Iron Nozzle	for J2-2 A
	B 碳化硼枪咀 Boron Carbide Nozzle	for J2-2 B
	C 钨钢枪咀 Tungsten Steel Nozzle	for J2-2 B
	D 陶瓷枪咀 Ceramic Nozzle	for J2-2 C

简易机器设备系列

POWER TOOLS SERIES

- 手提除膜机
- 手提抛光机
- 气动划痕修复机
- 简易钻孔机
- 简易切割机

CUTTING & GRINDING TOOLS SERIES

- 烧结切割片
- 电镀切割片
- 打磨片



POWER TOOLS SERIES

手提式Low-E除膜机 Low-E Coating Removal Hand Machine



编号 Code	K1-1
额定输入功率 Rate Power Input	1050w
负载电流 No-load speed	5.3A
空载转速 Max.Rotate Speed	600-3000r/min
除膜轮直径 Wheel Diameter	200mm

台式Low-E除膜机 Low-E Coating Removal Table Machine



■ 配合除膜轮用于镀膜玻璃加工时，除去玻璃边缘的金属层。

编号 Code	K1-2
电源 Power supply	单项交流 220v 50Hz AC220V, single phase, 50HZ
额定输入功率 Rate Power Input	2.2kw
空载转速 Max.Rotate Speed	2800r/min
除膜轮 Wheel Size	200×76.2×10mm
宽度可调尺寸 The Range of Coating Removal Size	10-100mm
厚度可调尺寸 Glass Thickness Range	可根据玻璃厚度随意调节 Thickness adjustable per the glass
Application: Fix with coating removal wheel, it's special for removing the coating from glass surface	

玻璃划痕修复工具 Glass Scratch Removal Tools



编号 Code	K1-3
角磨机 Grinder	1020w, 220v, 50Hz, 13000r/min
干磨片 Grinding Disc(Dry use)	2", 3"
羊毛片 Felt Pad	2", 3"
海绵抛光盘 Sponge Polishing Pad	2", 3", 5"
抛光膏 Polishing Cream	N/A
底托 Connetting Base	2", 3", 5"



12

简易机器设备系列

普通手提抛光机 Standard Hand Polisher

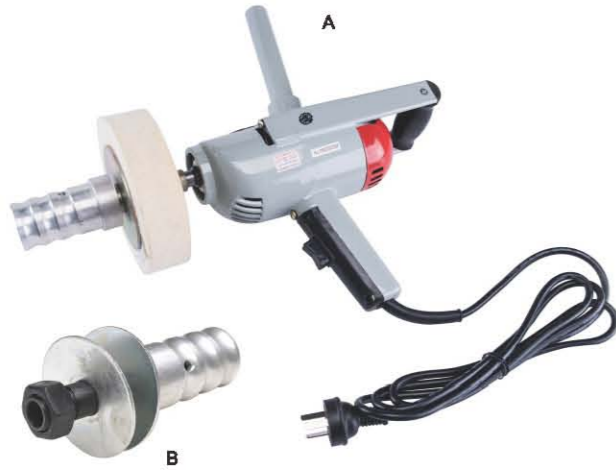

编号
Code K2-1

优质手提抛光机 Upgraded Hand Polisher

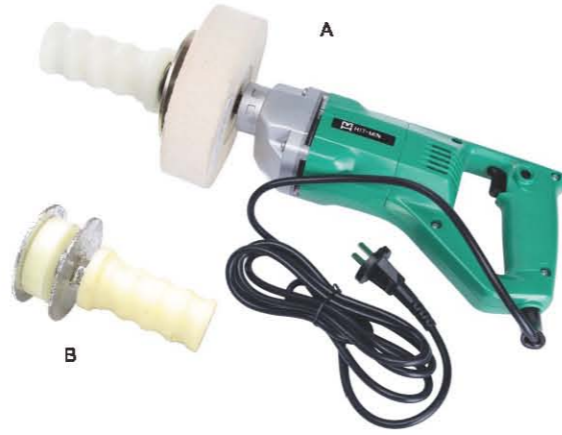

编号
Code K2-2

砂轮机 Bench Grinder



编号
Code K3-1

角磨机(博世牌) Grinder(BOSCH)



编号
Code K3-2

多功能磨边机 Multifunctional Edge Grinding & Polishing Machine



编号
Code K2-3

简易钻孔机 Drilling Machine



编号
Code K2-4

角磨机(格锐牌) Grinder(GERUI)



编号
Code K3-3

手电钻(格锐牌) Hand Drill(GERUI)



编号
Code K3-4

13

电动切割、打磨工具系列

13

电动切割、打磨工具系列

直径300-150mm玻璃切割片 Sintering Cutting Disc



编号 Code	规格 Dia
K4-1	150mm,200mm,250mm,300mm

安华切割片 Cutting Disc

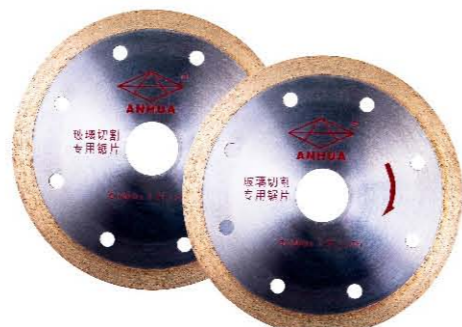

编号 Code	规格 Dia
K4-2	80mm,100mm

金刚石手擦 Diamond Hand Pad



编号 Code	K5-1
------------	------

砂布轮打磨叶片 Flap Wheel



编号 Code	K5-2
------------	------

牧田切割片 Cutting Disc(for Makita)



编号 Code	规格 Dia
K4-3	85mm

金刚石磨盘 Diamond Grinding Disc



编号 Code	K4-4
Remark:	With magnetic back

GC/WA打磨片 GC Glass Grinding Disc



编号 Code	K5-3
------------	------

PVA海绵抛光轮 PVA Spongy Polishing Wheel



编号 Code	K5-4
------------	------

金刚石打磨片 Grinding Disc



编号 Code	K4-5
------------	------

直径100mm电镀切割片 Electroplated Cutter Disc



编号 Code	K4-6
------------	------

13

电动切割、打磨工具系列

角磨机除膜尼龙轮 (红色) Nylon Wheel (Red)
Mounted On grinder for
Edge Deletion



编号
Code K5-5

优质带盖羊毛片 (橙色) Capped Wool Felt Disc



编号
Code K5-6

砂带 Grinding Belt

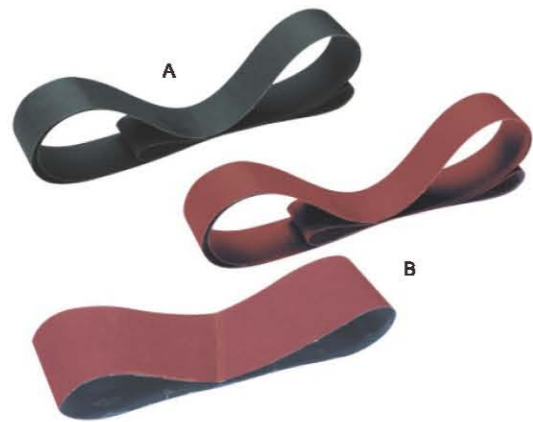

编号
Code K5-7

烧结磨片 Sintered Diamond Grinding Disc



编号
Code K6-1

机械配件系列

MACHINE ACCESSORIES

- 铝托盘/铝托座
- 其他配件
- 压板/链条
- 防水套
- 水泵/电机



铝托盘 Aluminum Mounting Plate



编号 Code L1-1

铝托座 Aluminum Base



编号 Code L1-2

压盖 Aluminum Fitting



编号 Code L1-3

百节喉水管、接头 Water Pipe/Connector

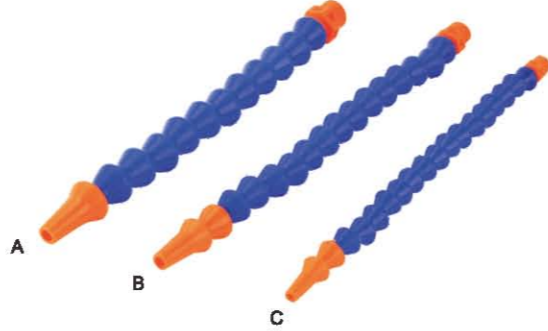

编号 Code L2-1

皮带/同步带 Timed Belt



编号 Code L2-2

毛刷 Brush



编号 Code L2-3

电机、水泵 Motor / Water Pump

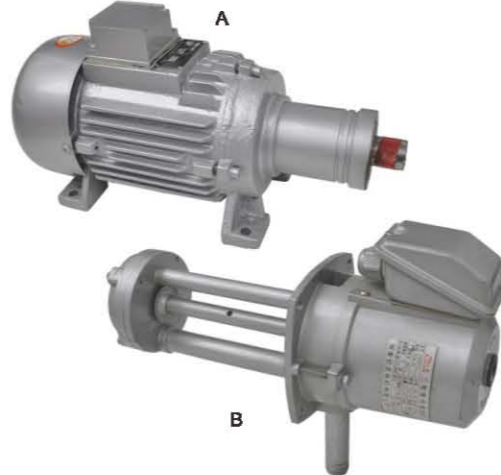

编号 Code L2-4

优质输送链条和斜面胶粒 Upgraded Conveyor Chain & Rubber Pad

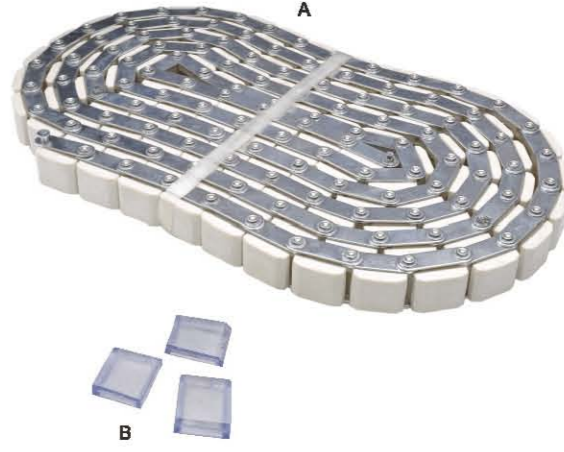

编号 Code L2-5

输送链条和斜面胶粒 Conveyor Chain & Rubber Pad



编号 Code L2-6

直边机防水套 Watercover for Straight-line Edger



编号 Code L2-7

14

机械配件系列

直边机压板 Pressure Plate for Straight Line Edging Machine

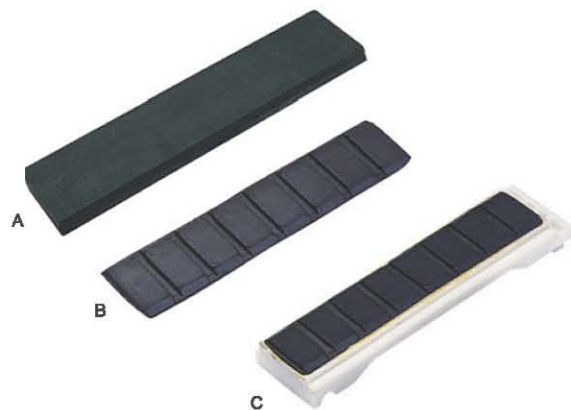

编号
Code L3-1

压板 Pressure Plate(For Bavelloni)

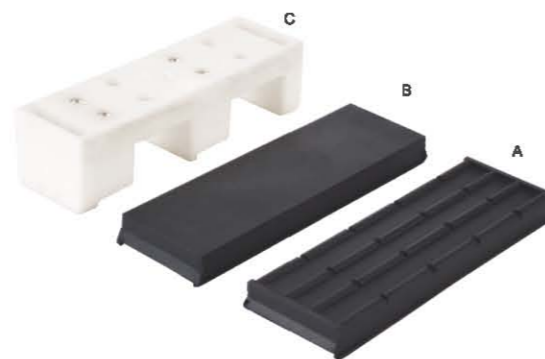

编号
Code L3-2

输送铁链条 Supporting Frame Pulley

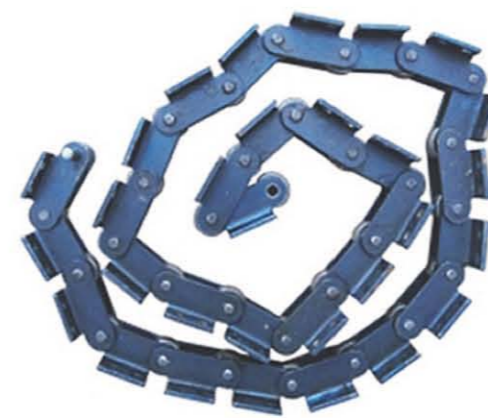

编号
Code L3-5

靠轮 Support Guide Wheel



编号
Code L3-6

压板 Pressure Plate

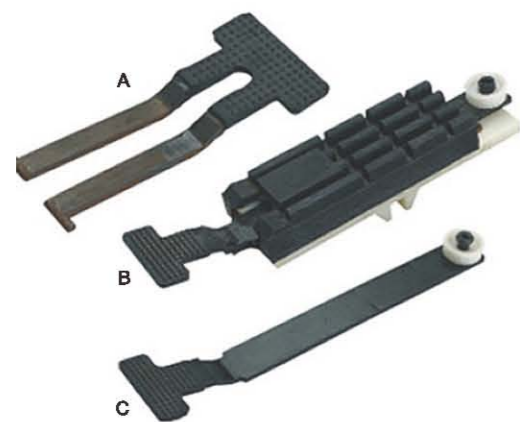

编号
Code L3-3

斜边机后压板定制 Rear Pressure Plate(Customized)



编号
Code L3-4

靠轮 Support Guide Wheel

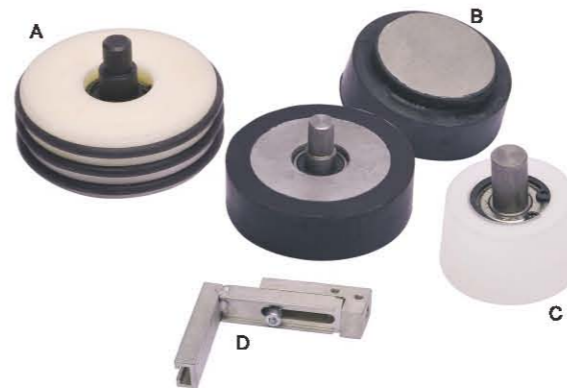

编号
Code L3-7

切割机上片吸盘 Glass Loading Suction for CNC Cutting Table



编号
Code L3-8

14

机械配件系列

14

机械配件系列

异型机吸盘 Sucker for Shape Machine



编号
Code L4-1

推拉阀 Switch Valve



编号
Code L4-2

进口真空发生器 Vacuum Generator (Imported)



编号
Code L4-3

真空发生器 Vacuum Generator



编号
Code L4-4

气缸 Cylinder



编号
Code L4-5

固特继电器 Relay



编号
Code L4-6

U型玻璃护夹 U Type Glass Clip



编号
Code L4-7

数字器 Position Indicator



编号
Code L4-8

万向水管三通接头 Tee Coupling for Universal Water Pipe



编号
Code L4-9

玻璃捆绑绳 Fastening Rope for Glass



编号
Code L5-1

钢化炉防火绳 Kevlar Rope and Tape for Toughening Furnace



编号
Code L5-2

绿色圆带 Polyurethane Rope Belt



编号
Code L5-3

吊带 Glass Sling



编号
Code L5-4

防水标签 Water Proof Tag



编号
Code L6-1

14

机械配件系列

15

玻璃辅材、硅酮胶系列

刮胶棉 Scraping Sponge and Roller for Insulating Glass

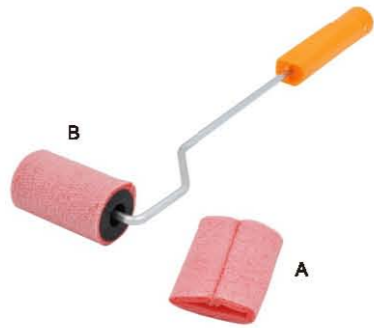

编号 Code	款式 Type	
F6-2	A	Scraping Sponge
	B	Scraping Roller

作业口罩 Mask



编号
Code L6-3

欧利雅玻璃胶(硬包装) OLA Silicone Sealant(Cartridge)



编号
Code M1-1

欧利雅玻璃胶(软包装) OLA Silicone Sealant(Sausage)



编号
Code M1-2

Low-E测膜笔 Low-E Testing Pen



编号
Code L6-4

邦迪防水创口贴 Waterproof Woundplast(Band-aid)



编号
Code L6-5

手动玻璃胶枪(软装专用) Silicone Sealant Gun for Sausage



编号
Code M2-1

手动玻璃胶枪(硬装专用) Silicone Sealant Gun for Cartridge



编号
Code M2-2

医用脱脂纱布绷带 Medical Absorbent Gauze Bandage
Medical Tape



编号
Code L6-6

进口耳塞 Earplug(Imported)



编号
Code L6-7

胶枪及胶使用图例 Using Direction



15

玻璃辅材、硅酮胶系列



氧化铈抛光粉 Cerium Oxide



■ 适用于高精密光学镜片, 液晶显示屏玻璃, 手机屏玻璃等

编号 Code	AN-718
外观 Color	纯白色粉末 White
参数 Parameter	REO≥96% CeO2/REO≥70%
D50	0.8-1.0um
D100	≤3.2um
悬浮性 Suspension	好 Good
包装 Packing	5KG/袋, 25KG/箱, 20-35KG/桶 20kgs/plastic pail, 540kgs/pallet

Application: Excellent Polishing For Precious Optical Lens, LED Screen, Mobile LED Screen Etc.

氧化铈抛光粉 Cerium Oxide



■ 各类光学玻璃, 电子玻璃, 液晶屏, 手机屏, 超白镜面, 汽车后视镜等

编号 Code	AN-738
外观 Color	红色粉末 Pink
参数 Parameter	REO≥96% CeO2/REO≥70%
D50	1.2-1.3um
D100	≤3.2um
悬浮性 Suspension	好 Good
包装 Packing	20KG/箱 20kgs/plastic pail, 540kgs/pallet

Application: Excellent Polishing For Precious Optical Lens, LED Screen, Mobile LED Screen Etc.

氧化铈抛光粉 Cerium Oxide



■ 适用于高精密光学镜片, 液晶显示屏玻璃, 手机屏玻璃等

编号 Code	AN-818
外观 Color	纯白色粉末 White
参数 Parameter	REO≥99.9% CeO2/REO≥99.9%
D50	0.8-1.0um
D100	≤3.2um
悬浮性 Suspension	好 Good
包装 Packing	5KG/袋, 25KG/箱, 20-35KG/桶 20kgs/plastic pail, 540kgs/pallet

Application: Excellent Polishing For Precious Optical Lens, LED Screen, Mobile LED Screen Etc.

氧化铈抛光粉 Cerium Oxide



■ 适用于眼镜片, 相机镜头, 摄像机镜头, 棱镜, 透镜, 过滤镜等

编号 Code	AN-828
外观 Color	红色粉末 Pink
参数 Parameter	REO≥95% CeO2/REO≥70%
D50	1.0-1.2um
D100	≤2.0um
悬浮性 Suspension	好 Good
包装 Packing	5KG/袋, 25KG/箱, 20-35KG/桶 20kgs/plastic pail, 540kgs/pallet

Application: Excellent Polishing For Precious Optical Lens, LED Screen, Mobile LED Screen Etc.

氧化铈抛光粉 Cerium Oxide



■ 普通玻璃的抛光, 斜边镜子, 马赛克等

编号 Code	AN-428
外观 Color	米白色粉末 White
参数 Parameter	REO≥80% CeO2/REO≥50%
D50	1.8-2.0um
D100	≤3.2um
悬浮性 Suspension	一般 Normal
包装 Packing	5KG/袋, 25KG/箱, 20-35KG/桶 20kgs/plastic pail, 540kgs/pallet

Application: Normal Use For Glass Polishing, Beveling Polishing, Mosaic Polishing.

氧化铈抛光粉 Cerium Oxide



■ 普通玻璃的抛光, 斜边镜子, 马赛克等

编号 Code	AN-438
外观 Color	红色粉末 Pink
参数 Parameter	REO≥80% CeO2/REO≥45%
D50	1.8-2.0um
D100	≤3.2um
悬浮性 Suspension	一般 Normal
包装 Packing	5KG/袋, 25KG/箱, 20-35KG/桶 20kgs/plastic pail, 540kgs/pallet

Application: Normal Use For Glass Polishing, Beveling Polishing, Mosaic Polishing.