

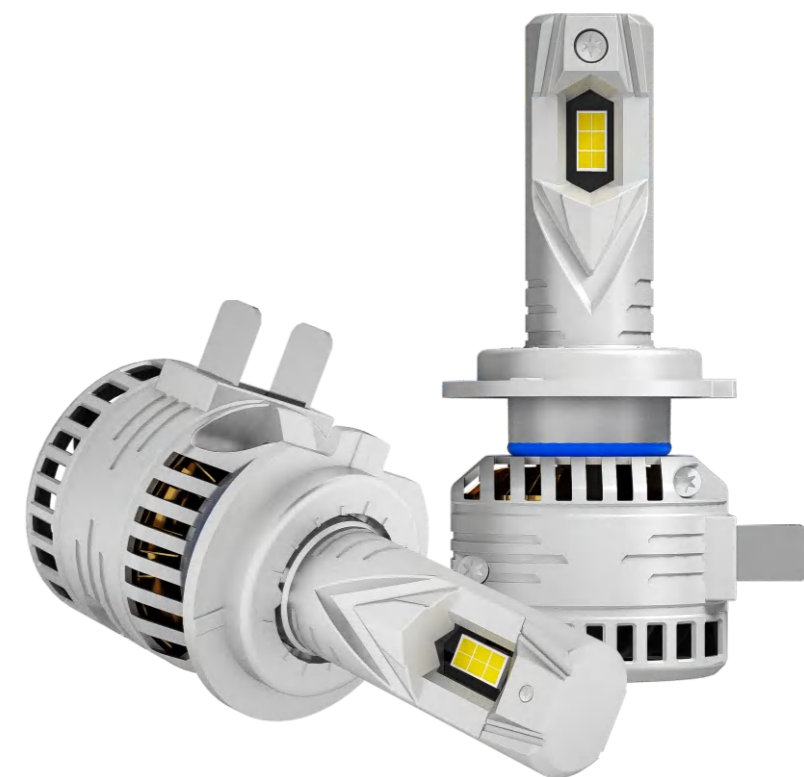

NSSC GROUP

# PROFESSIONAL AUTO LED LIGHTING



Guangzhou North and South Lighting Technology Co.,Ltd

Add:7th Bldg., No.68 Hongmian Ave.,Huadu,Guangzhou

Web: [www.nssclighting.com](http://www.nssclighting.com)

<http://nssclighting.com>

# CATALOG REFERENCE



ABOUT NSSC-----	01~04
2024 SPRING CANTON FAIR NEW PRODUCT SERIES----- (NL19PRO,NHC,FHZ,FH,Z9,Z7,Z5,Z4,X2,K5,K3,WORK LIGHT&LIGHT BAR)	05~34
PLUG & PLAY SERIES LED HEADLIGHT (FH/X9/NH/DX)-----	35~40
EXTERNAL DECODER SERIES LED HEADLIGHT (/Z3/Z6)-----	41~44
“ONE BODY” SERIES LED HEADLIGHT(K2)-----	45~46
MINI LENS SERIES LED HEADLIGHT (Z6L19/NL19)-----	47~50
LED PROJECTOR LENS LIGHT-----	51~54
BI-LED PROJECTOR LENS FOG LAMP-----	55
AUTO BULB REFERENCE-----	56~58
AUTOMOTIVE LED BULBS -----	59~74
FOLDABLE CAMPING LIGHT-----	75~76
“LIGHT FOR EVERYWHERE” SLIM LED BAR-----	77~78
LED WORK LIGHT & LIGHT BAR-----	79~80
BMW LED MARKER-----	81~82
DAYTIME RUNNING LIGHT-----	83~84
UNIVERSAL LED HEADLIGHT ADAPTER-----	85~86

## AUTOMOTIVE LED BULBS

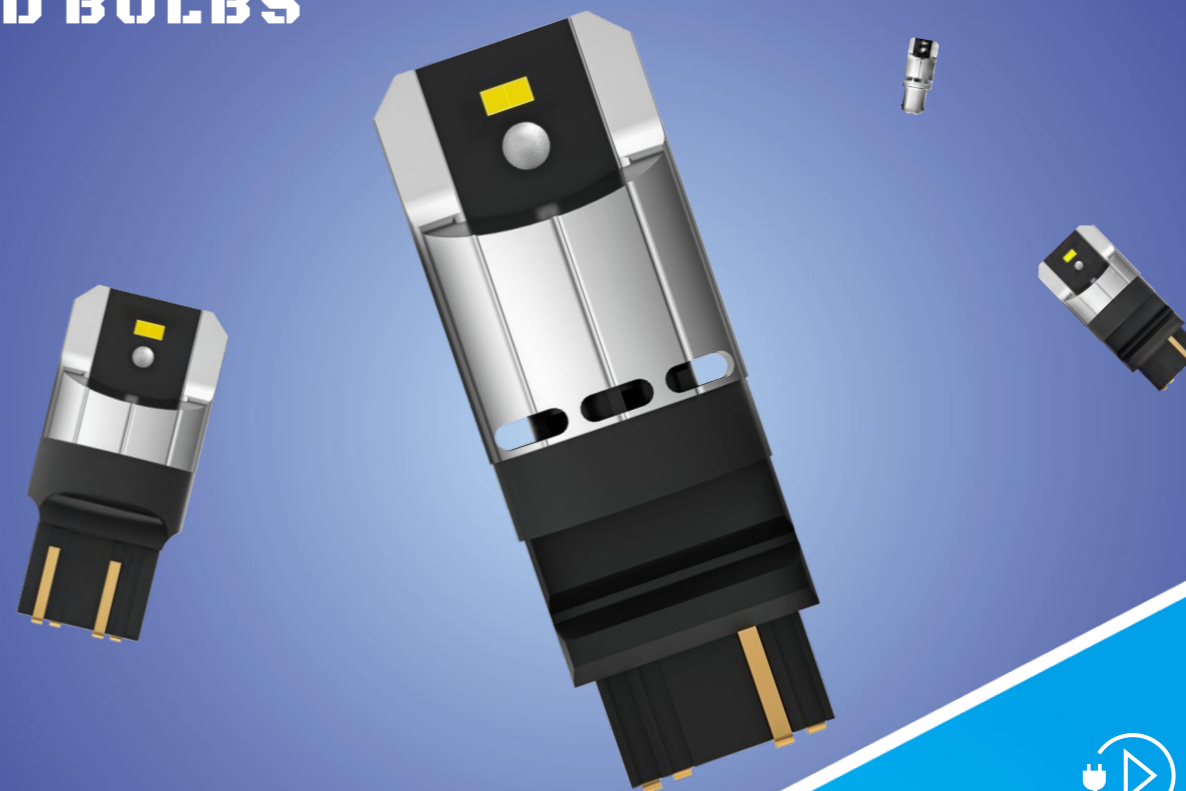

PLUG AND PLAY  
**MODEL:X9**

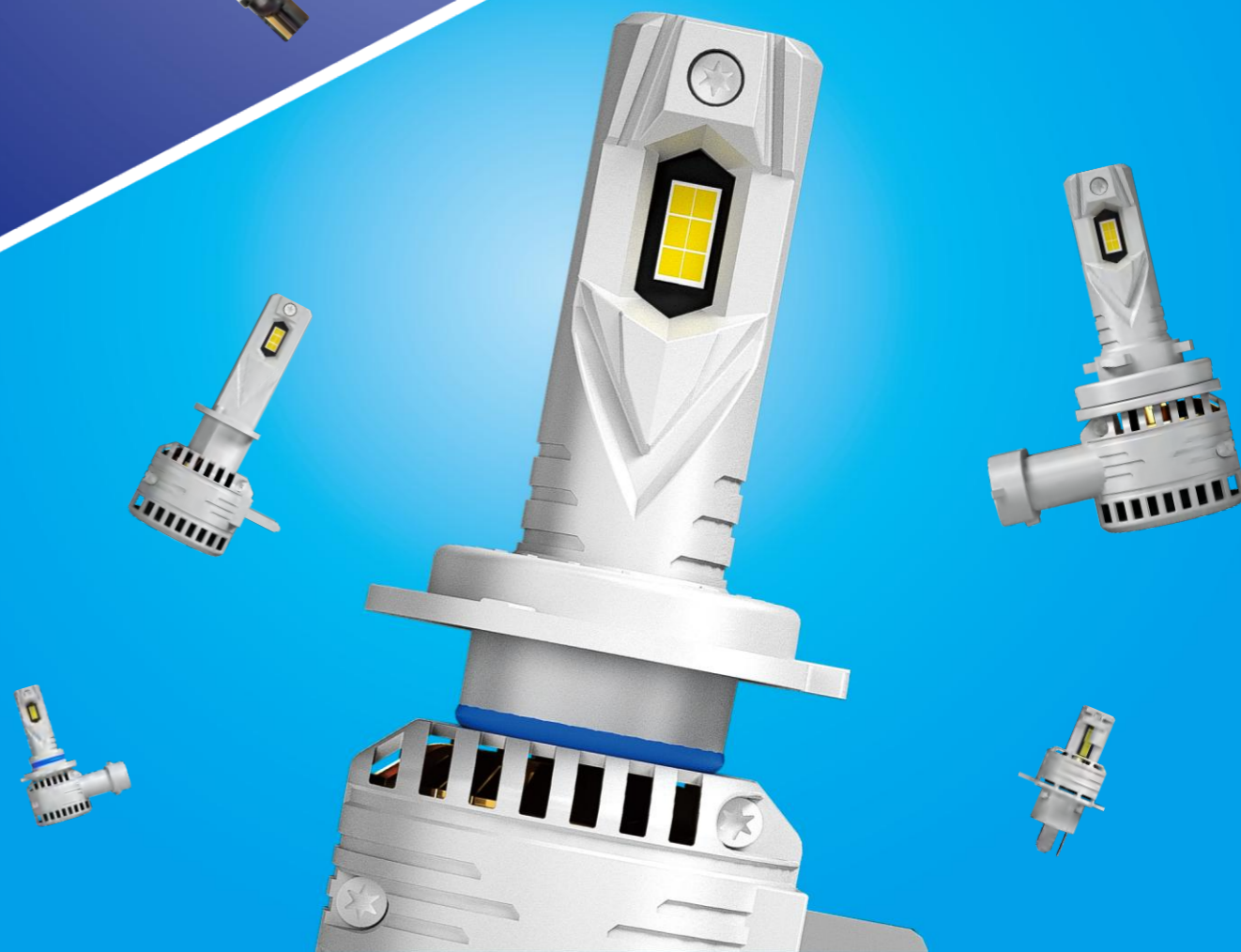

# ABOUT NSSC



## OVERVIEW

Established in 2006 and located in Guangzhou City, NSSC Group is one of the earliest HID ballast/LED light manufacturer for automotive lighting in China. Our GOAL is to supply the best quality automotive lights with affordable price !

## FACILITY & WORKFORCE

NSSC Group has over 86,000 sq. ft. facility with state-of-the-art equipments and seven in-house production lines. There are over 250 experienced workers in production lines and over 30 professional engineers to offer technical guidance and supervision.

## GREEN PRODUCTION

As a member of China Environmental Protection Association, NSSC Group strictly implements the related environment protection regulations. All products manufactured here are photobiologically tested and proved up to international standards and safe for human skin and eyes.

## MARKETING

NSSC Group has a strong sales team with 32 sales engineers, 12 merchandisers and 8 support staffs. They are well experienced, professional and have built up business relationships with hundreds of companies in over 85 countries across the world.

# ABOUT NSSC

## QUALITY CONTROL

NSSC is ISO9001, IATF16949 & ISO14001 certified and has perfect quality control system, all incoming materials and components will be strictly inspected and tested before used in mass production, all finished products must be entirely inspected and tested to ensure up to all preset standards before they are packed for delivery, NSSC will also positively do extra rigorous testing to verify our products' performance under harsh conditions.

### Incoming Materials and Components Inspection and Test

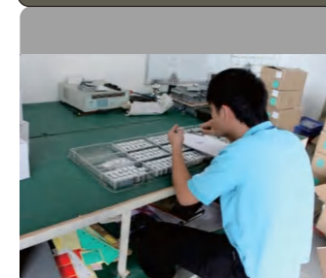

Appearance Inspection

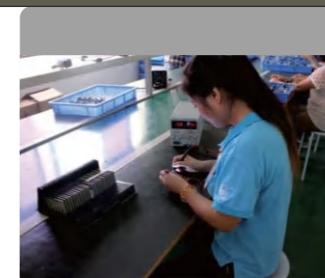

LED Chip Inspection

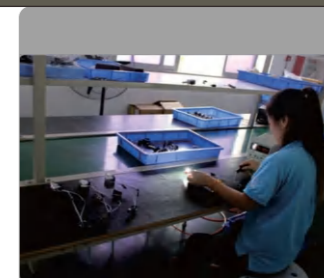

Cable Inspection



Thermostatic Dryer

### Finished Products Inspection and Test



Parameter Testing

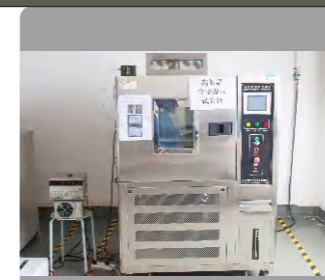

High-Low Temp Testing

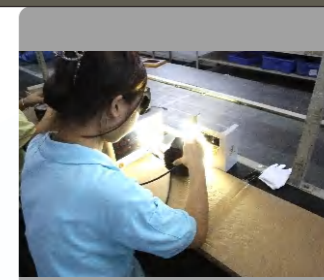

Finished Product Test

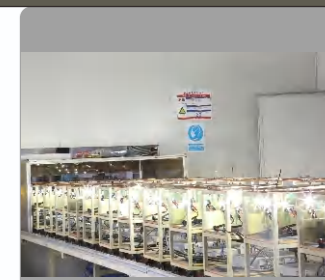

Aging Testing

### Extra Rigorous Test



Cable Bending Testing



Saline Spray Testing

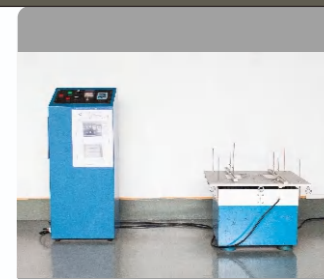

Vibration Test Machine



Tortured Testing

# ABOUT NSSC

## PRODUCT EVOLUTION

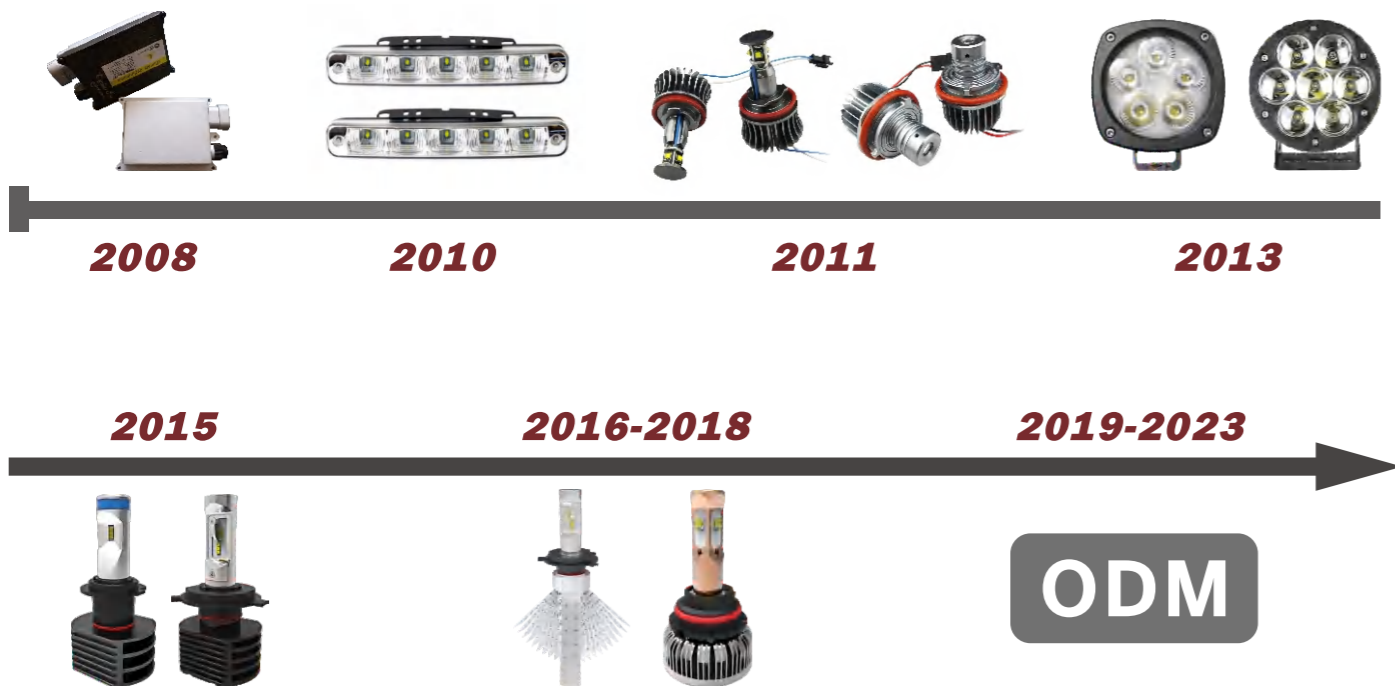

### Constant Innovation

- 2008:** China FIRST factory developed CANBUS FREE ballast.
- 2010:** China FIRST factory made FULL series Daytime Running Lights with both Emark R87 & R7 certification.
- 2011:** The FIRST factory with Full item of BMW led marker, with best quality .
- 2013:** Series tough&heavy duty LED light bars 4"-50 " and 4.3",6.5",9.7" led driving lights released, with very best quality, which called "China Rigid" by U. S. clients .
- 2015:** First fanless design, with perfect cut-off line headlights released .
- 2016-2018:** Start providing in-depth ODM products services to value clients for their own market, with great successes.
- 2019-2023:** Win great ODM cooperations, become a solution provider for professional automotive lighting.



# ABOUT NSSC

## ODM

NSSC has a R&D team with highest professional sense for products "Industrial Design - Optical Design - Structural Design - Circuit Design". Since 2015, NSSC start providing in-depth ODM products services to value clients for their own market, with great successes.

### INDUSTRIAL DESIGN & STRUCTURAL DESIGN

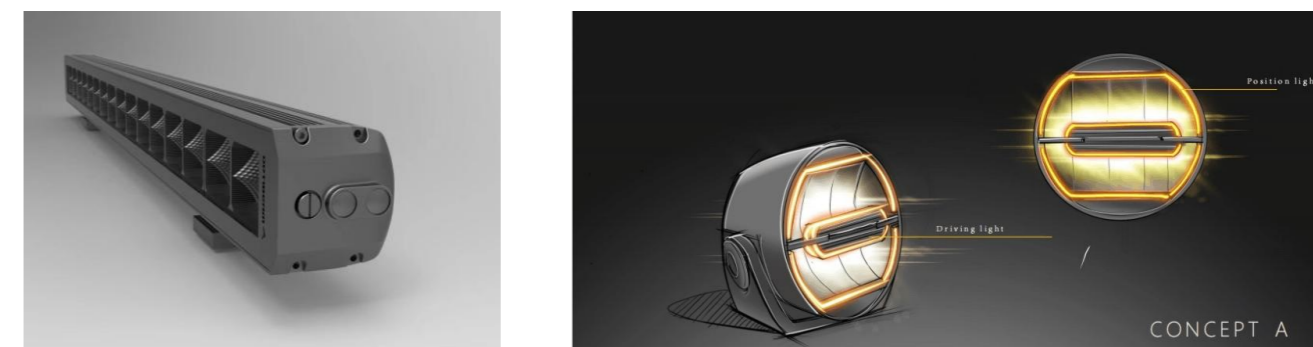

### PROFESSIONAL OPTICAL DESIGN



### CIRCUIT DESIGN

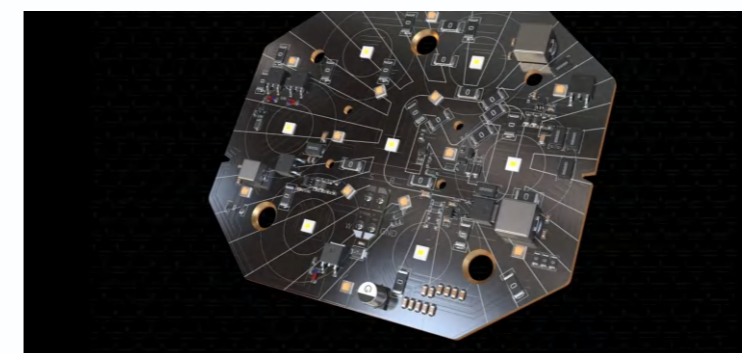

Design performance:  
 650M 1lux long range,  
 60m 1lux wide,  
 Meets ECE R149 Ref.40  
 Meet the standard of CISPR25  
 CLASS3

# APOLLO LIGHT

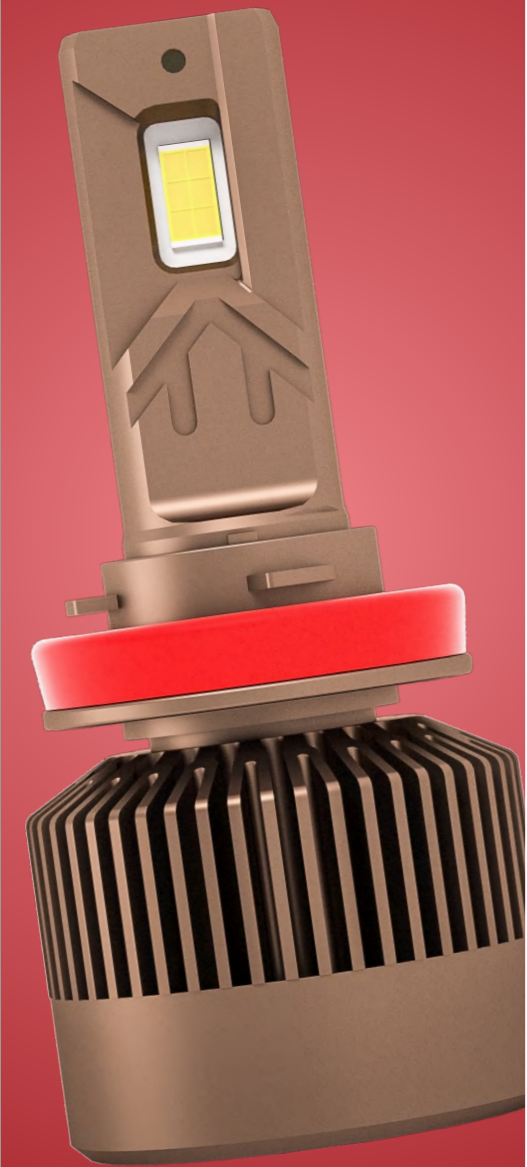

Z7

8000lm

# PURE LIGHT



X9

4500lm

# PURE LIGHT



NI19 PRO

5000lm

# CLASSIC

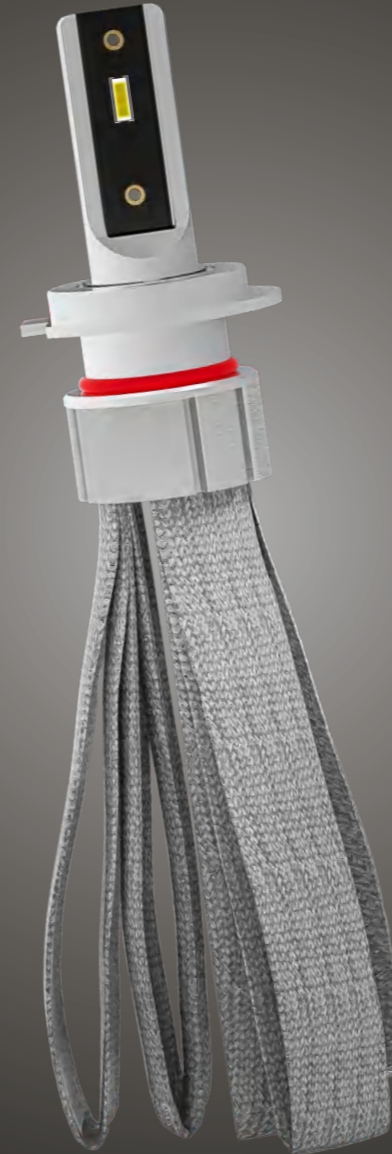

Z6

2700lm

# SEEKER PRO



FHZ

2500lm

# SEEKER



NHC

1800lm

# LED LIGHTING 5S-NL19PRO SERIES

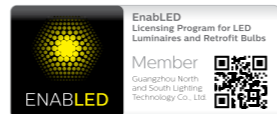

Scan code for products details

19MM MINI LENS DESIGN

LHD AND RHD ARE AVAILABLE

PERFECT CUTTING-LINE LIGHT PATTERN

STRONGLY SHINE DOWN ON ROAD

CANBUS ERROR FREE

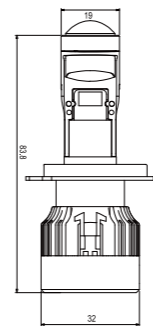
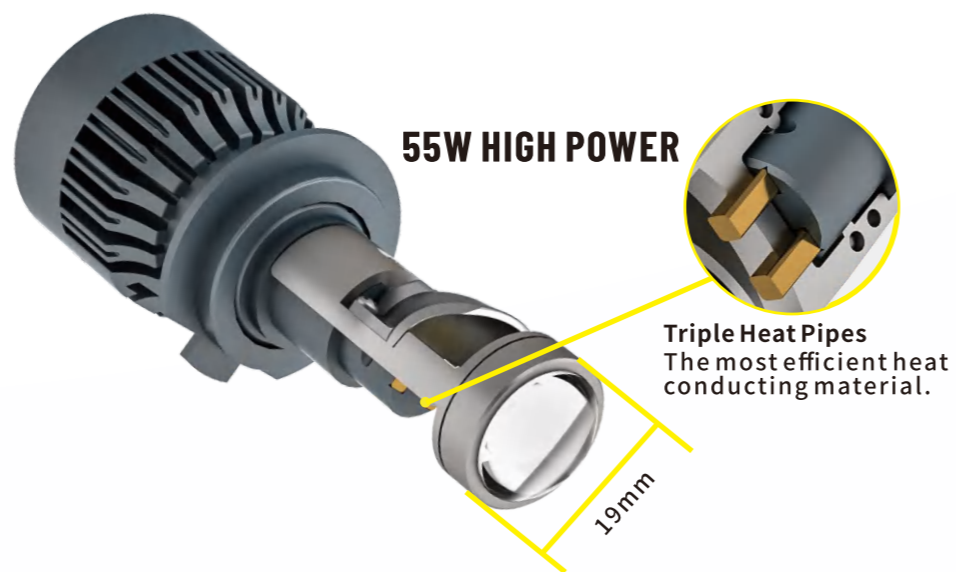

## H4

START POWER	WORKING POWER	VOLTAGE	LUMEN	LED CHIPS	COLOR TEMPERATURE
60W	55W	DC 9-32V	3860lm	7545 CSP	6000K

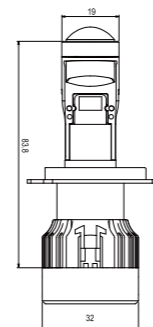

## H7

START POWER	WORKING POWER	VOLTAGE	LUMEN	LED CHIPS	COLOR TEMPERATURE
60W	55W	DC 9-32V	4000lm	7545 CSP	6000K

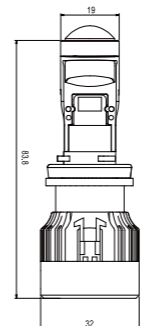

## H8/H9/H11

START POWER	WORKING POWER	VOLTAGE	LUMEN	LED CHIPS	COLOR TEMPERATURE
60W	55W	DC 9-32V	4000lm	7545 CSP	6000K

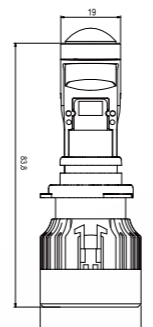

## 9005

START POWER	WORKING POWER	VOLTAGE	LUMEN	LED CHIPS	COLOR TEMPERATURE
60W	55W	DC 9-32V	4000lm	7545 CSP	6000K

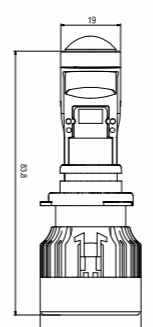

## 9006/9012

START POWER	WORKING POWER	VOLTAGE	LUMEN	LED CHIPS	COLOR TEMPERATURE
60W	55W	DC 9-32V	4000lm	7545 CSP	6000K

# LED LIGHTING 5S-NHC SERIES

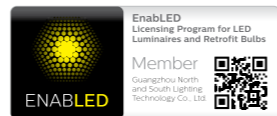

MINI 1:1 SAME SIZE AS HALOGEN BULB

PLUG & PLAY QUICK INSTALLATION

NO ADDITIONAL ADAPTER REQUIRED

STABLE WORKING POWER: 16W

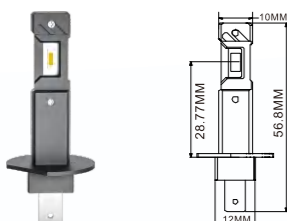
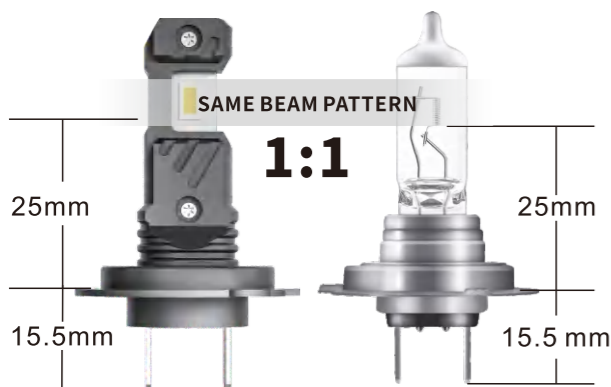

## H1

START POWER	WORKING POWER	VOLTAGE	LUMEN	LED CHIPS	COLOR TEMPERATURE
19W	7.5W	DC 12V	1278lm	1860 CSP	6000K

## 5S-NHC SERIES



## H4

START POWER	WORKING POWER	VOLTAGE	LUMEN	LED CHIPS	COLOR TEMPERATURE
20W	16W	DC 9-32V	1278lm	5530 CSP	6000K



## H7

START POWER	WORKING POWER	VOLTAGE	LUMEN	LED CHIPS	COLOR TEMPERATURE
20W	16W	DC 9-32V	1350lm	5530 CSP	6000K



## H8/H9/H11

START POWER	WORKING POWER	VOLTAGE	LUMEN	LED CHIPS	COLOR TEMPERATURE
20W	16W	DC 9-32V	1350lm	5530 CSP	6000K



## 9005

START POWER	WORKING POWER	VOLTAGE	LUMEN	LED CHIPS	COLOR TEMPERATURE
20W	16W	DC 9-32V	1350lm	5530 CSP	6000K



## 9006

START POWER	WORKING POWER	VOLTAGE	LUMEN	LED CHIPS	COLOR TEMPERATURE
20W	16W	DC 9-32V	1350lm	5530 CSP	6000K



## 9012

START POWER	WORKING POWER	VOLTAGE	LUMEN	LED CHIPS	COLOR TEMPERATURE
20W	16W	DC 9-32V	1350lm	5530 CSP	6000K

LED HEADLIGHT

# LED LIGHTING 5S-FHZ SERIES



- 1:1 SAME AS HALOGEN BULB
- PLUG & PLAY QUICK INSTALLATION
- NO ADDITIONAL ADAPTER REQUIRED
- CANBUS ERROR FREE

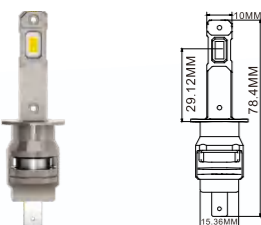
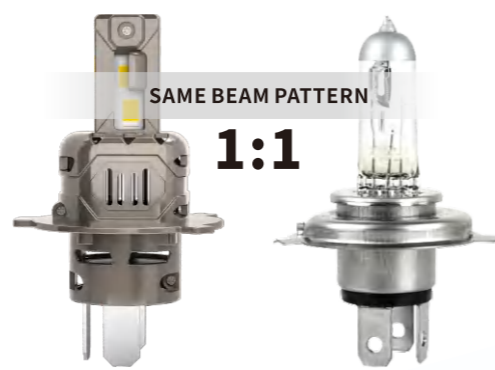
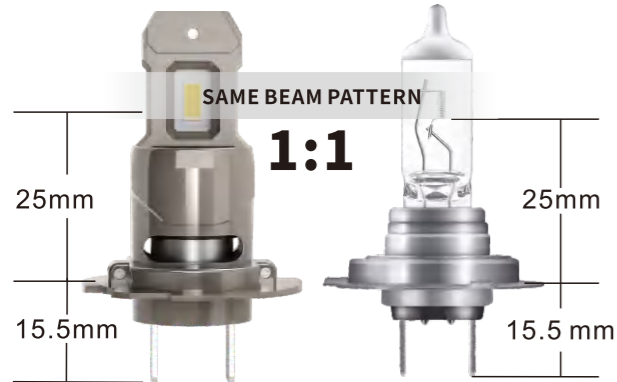

## H1

START POWER	WORKING POWER	VOLTAGE	LUMEN	LED CHIPS	COLOR TEMPERATURE
40W	21W	DC 12V	1691lm	3570 CSP	6000K

## 5S-FHZ SERIES

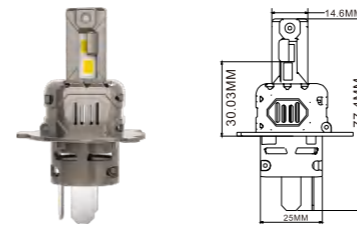

## H4

START POWER	WORKING POWER	VOLTAGE	LUMEN	LED CHIPS	COLOR TEMPERATURE
41W	21W	DC 12V	1691lm	3570 CSP	6000K

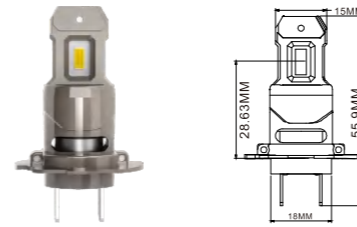

## H7

START POWER	WORKING POWER	VOLTAGE	LUMEN	LED CHIPS	COLOR TEMPERATURE
42W	23W	DC 12V	1840lm	3570 CSP	6000K

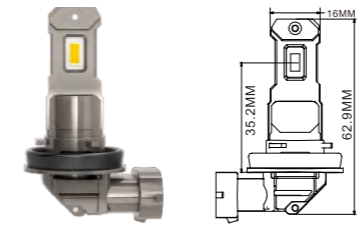

## H8/H9/H11

START POWER	WORKING POWER	VOLTAGE	LUMEN	LED CHIPS	COLOR TEMPERATURE
42W	23W	DC 12V	1840lm	3570 CSP	6000K

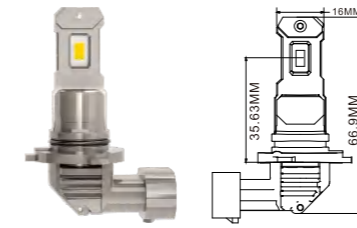

## 9005

START POWER	WORKING POWER	VOLTAGE	LUMEN	LED CHIPS	COLOR TEMPERATURE
42W	23W	DC 12V	1840lm	3570 CSP	6000K

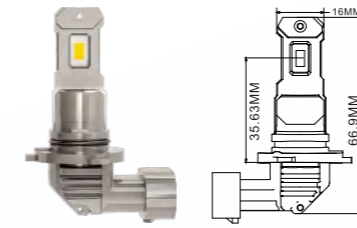

## 9006

START POWER	WORKING POWER	VOLTAGE	LUMEN	LED CHIPS	COLOR TEMPERATURE
42W	23W	DC 12V	1840lm	3570 CSP	6000K

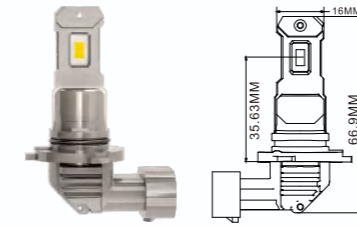

## 9012

START POWER	WORKING POWER	VOLTAGE	LUMEN	LED CHIPS	COLOR TEMPERATURE
42W	23W	DC 12V	1840lm	3570 CSP	6000K



5S-FH SERIES

# LED LIGHTING 5S-FH SERIES

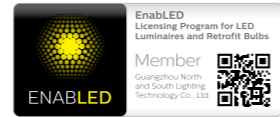

Scan code for products details

1:1 SAME AS HALOGEN BULB

PLUG & PLAY QUICK INSTALLATION

NO ADDITIONAL ADAPTER REQUIRED

CANBUS ERROR FREE



FAN built-in  
15,000 RPM Turbo Fan



SAME BEAM PATTERN

1:1

## H1

START POWER	WORKING POWER	VOLTAGE	LUMEN	LED CHIPS	COLOR TEMPERATURE
40W	21.8W	DC 12V	1710lm	3570 CSP	6000K

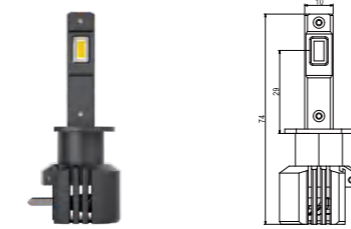

## H4

START POWER	WORKING POWER	VOLTAGE	LUMEN	LED CHIPS	COLOR TEMPERATURE
41W	20W	DC 12V	1623lm	3570 CSP	6000K

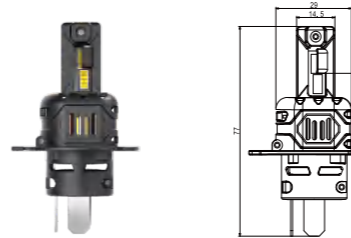

## H7

START POWER	WORKING POWER	VOLTAGE	LUMEN	LED CHIPS	COLOR TEMPERATURE
42W	22W	DC 12V	1750lm	3570 CSP	6000K

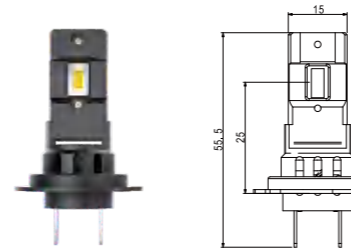

## H8/H9/H11

START POWER	WORKING POWER	VOLTAGE	LUMEN	LED CHIPS	COLOR TEMPERATURE
42W	22W	DC 12V	1750lm	3570 CSP	6000K

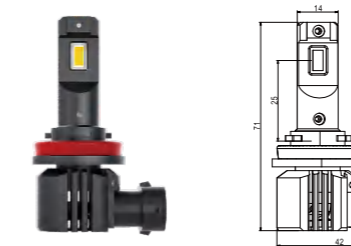

## 9005

START POWER	WORKING POWER	VOLTAGE	LUMEN	LED CHIPS	COLOR TEMPERATURE
42W	22W	DC 12V	1750lm	3570 CSP	6000K

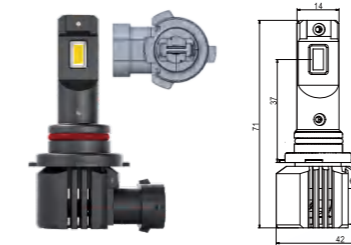

## 9006

START POWER	WORKING POWER	VOLTAGE	LUMEN	LED CHIPS	COLOR TEMPERATURE
42W	22W	DC 12V	1750lm	3570 CSP	6000K

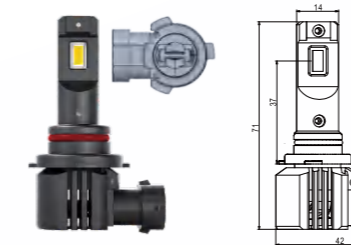

## 9012

START POWER	WORKING POWER	VOLTAGE	LUMEN	LED CHIPS	COLOR TEMPERATURE
42W	22W	DC 12V	1750lm	3570 CSP	6000K

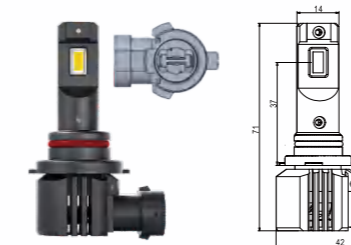

# LED LIGHTING 5S-Z9 SERIES



**Triple Heat Pipes**  
The most efficient heat  
conducting material.

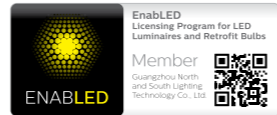

Scan code for  
products details

**TRIPLE HEAT PIPES + FAN  
COOLING**

**90 WATTS SUPER WORKING  
POWER**

**BUILT-IN STRONG CANBUS,  
ERROR FREE, NO FLASHING**

**PERFECTLY WORKING ON CAR,  
TRUCK AND MOTORCYCLE**

## 5S-Z9 SERIES

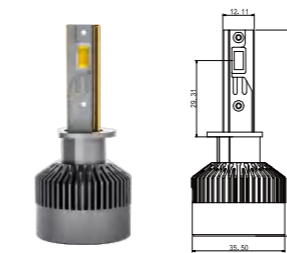

### H1

START POWER	WORKING POWER	VOLTAGE	LUMEN	LED CHIPS	COLOR TEMPERATURE
91W	70W	DC 9-32V	5800lm	3570 CSP	6000K

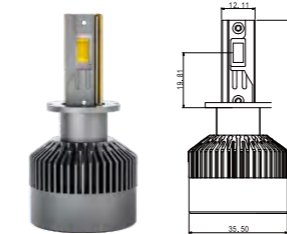

### H3

START POWER	WORKING POWER	VOLTAGE	LUMEN	LED CHIPS	COLOR TEMPERATURE
91W	70W	DC 9-32V	5800lm	4575 CSP	6000K

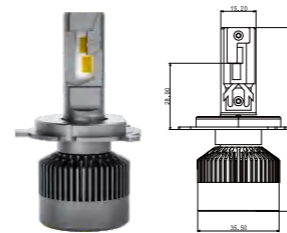

### H4

START POWER	WORKING POWER	VOLTAGE	LUMEN	LED CHIPS	COLOR TEMPERATURE
110W	65W	DC 9-32V	4800lm	4575 CSP	6000K

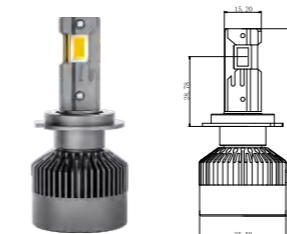

### H7

START POWER	WORKING POWER	VOLTAGE	LUMEN	LED CHIPS	COLOR TEMPERATURE
110W	86W	DC 9-32V	6800lm	4575 CSP	6000K

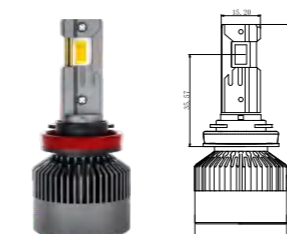

### H8/H9/H11

START POWER	WORKING POWER	VOLTAGE	LUMEN	LED CHIPS	COLOR TEMPERATURE
110W	86W	DC 9-32V	6800lm	4575 CSP	6000K

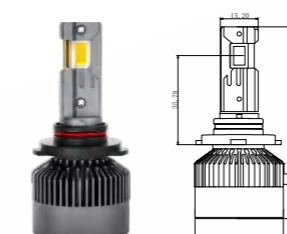

### 9005

START POWER	WORKING POWER	VOLTAGE	LUMEN	LED CHIPS	COLOR TEMPERATURE
110W	86W	DC 9-32V	6800lm	4575 CSP	6000K

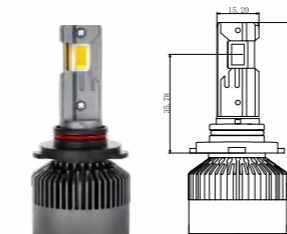

### 9006/9012

START POWER	WORKING POWER	VOLTAGE	LUMEN	LED CHIPS	COLOR TEMPERATURE
110W	86W	DC 9-32V	6800lm	4575 CSP	6000K



# LED LIGHTING 5S-Z7 SERIES

## 5S-Z7 SERIES

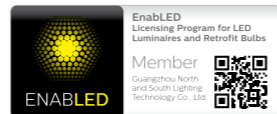

Scan code for products details

TRIPLE HEAT PIPES + FAN COOLING

90 WATTS SUPER POWER

BUILT-IN STRONG CANBUS, ERROR FREE, NO FLASHING

PERFECTLY WORKING ON CAR, TRUCK AND MOTORCYCLE



Triple Heat Pipes  
The most efficient heat conducting material.

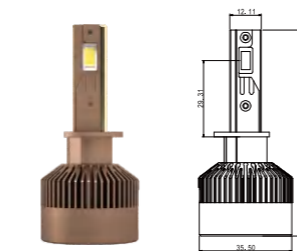

### H1

START POWER	WORKING POWER	VOLTAGE	LUMEN	LED CHIPS	COLOR TEMPERATURE
91W	70W	DC 9-32V	5800lm	3570 CSP	6000K

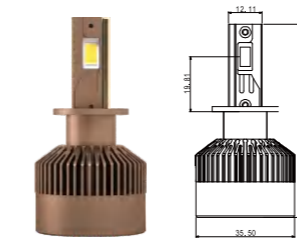

### H3

START POWER	WORKING POWER	VOLTAGE	LUMEN	LED CHIPS	COLOR TEMPERATURE
91W	70W	DC 9-32V	5800lm	3570 CSP	6000K

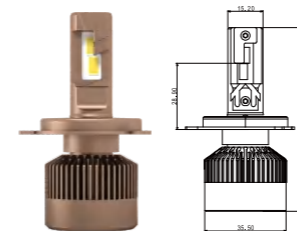

### H4

START POWER	WORKING POWER	VOLTAGE	LUMEN	LED CHIPS	COLOR TEMPERATURE
110W	60W	DC 9-32V	4500lm	3570 CSP	6000K

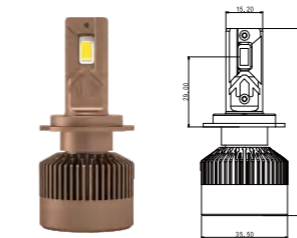

### H7

START POWER	WORKING POWER	VOLTAGE	LUMEN	LED CHIPS	COLOR TEMPERATURE
98W	78W	DC 9-32V	6300lm	3570 CSP	6000K

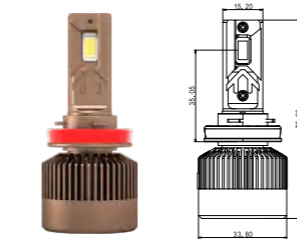

### H8/H9/H11

START POWER	WORKING POWER	VOLTAGE	LUMEN	LED CHIPS	COLOR TEMPERATURE
98W	78W	DC 9-32V	6300lm	3570 CSP	6000K

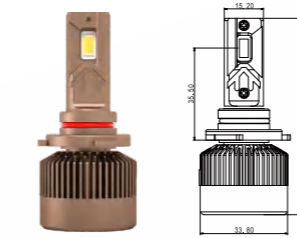

### 9005

START POWER	WORKING POWER	VOLTAGE	LUMEN	LED CHIPS	COLOR TEMPERATURE
98W	78W	DC 9-32V	6300lm	3570 CSP	6000K

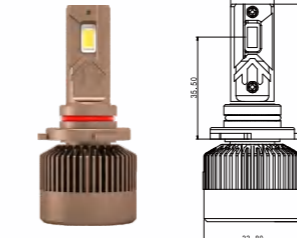

### 9006/9012

START POWER	WORKING POWER	VOLTAGE	LUMEN	LED CHIPS	COLOR TEMPERATURE
98W	78W	DC 9-32V	6300lm	3570 CSP	6000K

# LED LIGHTING 5S-Z5 SERIES

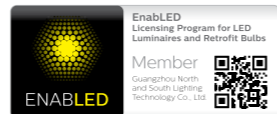

Scan code for products details

HEAT PIPE +FAN COOLING

SUPER STABLE DESIGN,  
WORKING POWER:54WATTS

CANBUS ERROR FREE

PERFECTLY WORKING ON CAR,  
TRUCK AND MOTORCYCLE

Heat Pipe +Fan Cooling

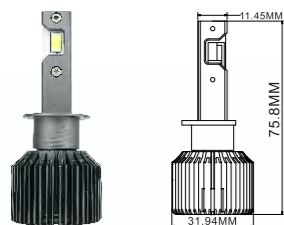

## H1

START POWER	WORKING POWER	VOLTAGE	LUMEN	LED CHIPS	COLOR TEMPERATURE
52W	51W	DC 9-32V	4000lm	3570 CSP	6000K

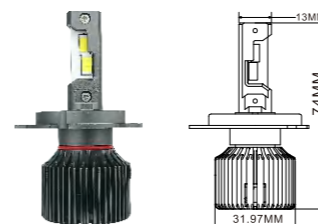

## H4

START POWER	WORKING POWER	VOLTAGE	LUMEN	LED CHIPS	COLOR TEMPERATURE
53W	52W	DC 9-32V	4320lm	3570 CSP	6000K

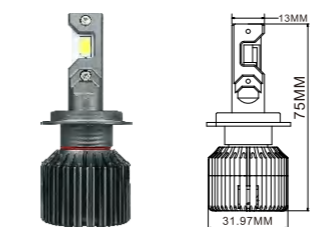

## H7

START POWER	WORKING POWER	VOLTAGE	LUMEN	LED CHIPS	COLOR TEMPERATURE
55W	54W	DC 9-32V	4320lm	3570 CSP	6000K

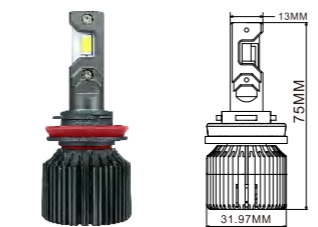

## H8/H9/H11

START POWER	WORKING POWER	VOLTAGE	LUMEN	LED CHIPS	COLOR TEMPERATURE
55W	54W	DC 9-32V	4320lm	3570 CSP	6000K

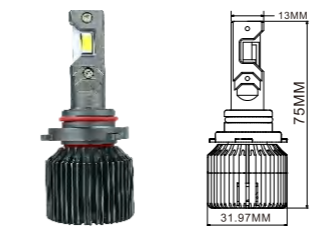

## 9005

START POWER	WORKING POWER	VOLTAGE	LUMEN	LED CHIPS	COLOR TEMPERATURE
55W	54W	DC 9-32V	4320lm	3570 CSP	6000K

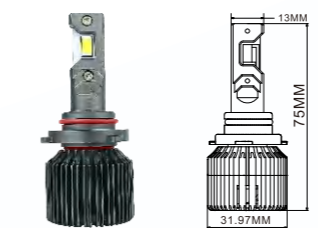

## 9006

START POWER	WORKING POWER	VOLTAGE	LUMEN	LED CHIPS	COLOR TEMPERATURE
55W	54W	DC 9-32V	4320lm	3570 CSP	6000K

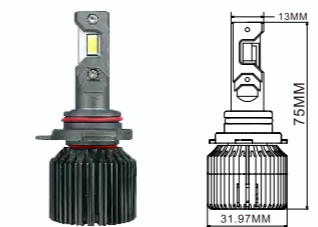

## 9012

START POWER	WORKING POWER	VOLTAGE	LUMEN	LED CHIPS	COLOR TEMPERATURE
55W	54W	DC 9-32V	4320lm	3570 CSP	6000K

# LED LIGHTING 5S-Z4 SERIES



Scan code for products details

HEAT PIPE + FAN COOLING

BRIGHTER AND MORE CONCENTRATED LIGHT

EASY "PLUG & PLAY" INSTALLATION

CANBUS ERROR FREE

Heat Pipe + Fan Cooling

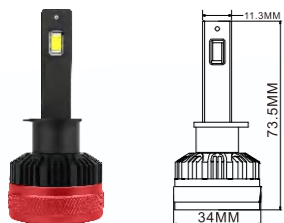

## H1

START POWER	WORKING POWER	VOLTAGE	LUMEN	LED CHIPS	COLOR TEMPERATURE
46W	42W	DC 9-32V	3690lm	3570 CSP	6000K



## H3

START POWER	WORKING POWER	VOLTAGE	LUMEN	LED CHIPS	COLOR TEMPERATURE
46W	42W	DC 9-32V	3690lm	3570 CSP	6000K

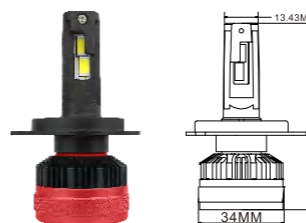

## H4

START POWER	WORKING POWER	VOLTAGE	LUMEN	LED CHIPS	COLOR TEMPERATURE
46W	42W	DC 9-32V	3820lm	3570 CSP	6000K

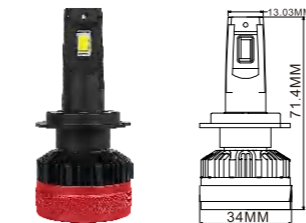

## H7

START POWER	WORKING POWER	VOLTAGE	LUMEN	LED CHIPS	COLOR TEMPERATURE
46W	42W	DC 9-32V	3900lm	3570 CSP	6000K



## H8/H9/H11

START POWER	WORKING POWER	VOLTAGE	LUMEN	LED CHIPS	COLOR TEMPERATURE
46W	42W	DC 9-32V	3900lm	3570 CSP	6000K



## 9005/9006/9012

START POWER	WORKING POWER	VOLTAGE	LUMEN	LED CHIPS	COLOR TEMPERATURE
46W	42W	DC 9-32V	3900lm	3570 CSP	6000K

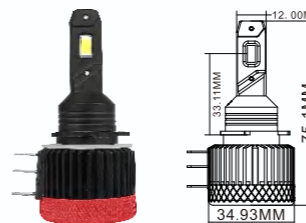

## H15

START POWER	WORKING POWER	VOLTAGE	LUMEN	LED CHIPS	COLOR TEMPERATURE
46W	42W	DC 9-32V	3820lm	3570 CSP	6000K

# LED LIGHTING 5S-X2 SERIES

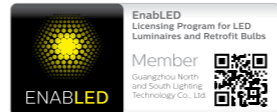

Scan code for products details

1:1 SMAE BEAM DESIGN AS HALOGEN BULB

PLUG&PLAY QUICK INSTALLATION

HIGH SPEED MINI TURBO FAN COOLING

GOOD CANBUS

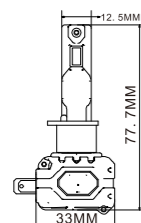

## H1

START POWER	WORKING POWER	VOLTAGE	LUMEN	LED CHIPS	COLOR TEMPERATURE
30W	20W	DC 12V	1591lm	3570 CSP	6000K

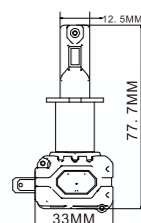

## H3

START POWER	WORKING POWER	VOLTAGE	LUMEN	LED CHIPS	COLOR TEMPERATURE
30W	20W	DC 12V	1578lm	3570 CSP	6000K

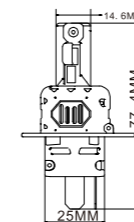

## H4

START POWER	WORKING POWER	VOLTAGE	LUMEN	LED CHIPS	COLOR TEMPERATURE
30W	20W	DC 12V	1760lm	3570 CSP	6000K

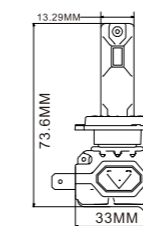

## H7

START POWER	WORKING POWER	VOLTAGE	LUMEN	LED CHIPS	COLOR TEMPERATURE
30W	20W	DC 12V	1760lm	3570 CSP	6000K

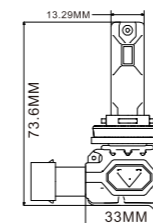

## H8/H9/H11

START POWER	WORKING POWER	VOLTAGE	LUMEN	LED CHIPS	COLOR TEMPERATURE
30W	20W	DC 12V	1760lm	3570 CSP	6000K

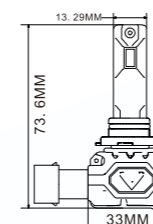

## 9005

START POWER	WORKING POWER	VOLTAGE	LUMEN	LED CHIPS	COLOR TEMPERATURE
30W	20W	DC 12V	1760lm	3570 CSP	6000K

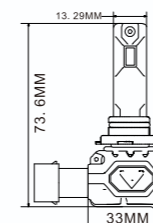

## 9006/9012

START POWER	WORKING POWER	VOLTAGE	LUMEN	LED CHIPS	COLOR TEMPERATURE
30W	20W	DC 12V	1760lm	3570 CSP	6000K

# LED LIGHTING 5S-K5 SERIES

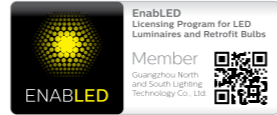

Scan code for products details

24W FULL POWER OUTPUT

INTEGRATED ELECTRONICS,  
NO EXTRA DRIVERS

COMPACT ALL-IN-ONE DESIGN  
FOR PLUG-AND-PLAY USE

VOLTAGE: 9-32V

EXCELLENT COOLING VIA  
EFFECTIVE ACTIVE FAN

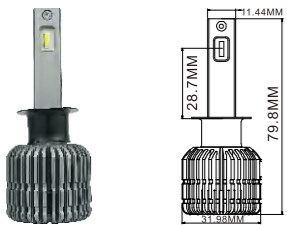

## H1

START POWER	WORKING POWER	VOLTAGE	LUMEN	LED CHIPS	COLOR TEMPERATURE
30W	24W	DC 9-32V	2000lm	1860 CSP	6000K

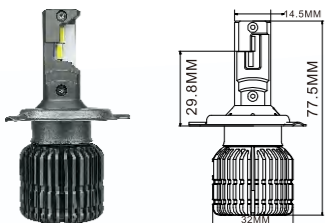

## H4

START POWER	WORKING POWER	VOLTAGE	LUMEN	LED CHIPS	COLOR TEMPERATURE
30W	24W	DC 9-32V	2000lm	1860 CSP	6000K

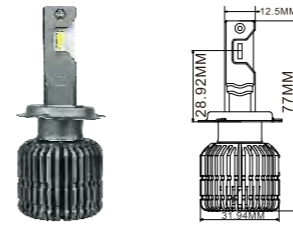

## H7

START POWER	WORKING POWER	VOLTAGE	LUMEN	LED CHIPS	COLOR TEMPERATURE
30W	24W	DC 9-32V	2000lm	1860 CSP	6000K

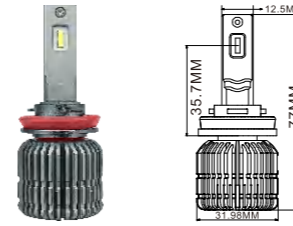

## H8/H9/H11

START POWER	WORKING POWER	VOLTAGE	LUMEN	LED CHIPS	COLOR TEMPERATURE
30W	24W	DC 9-32V	2000lm	1860 CSP	6000K

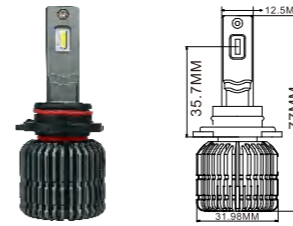

## 9005

START POWER	WORKING POWER	VOLTAGE	LUMEN	LED CHIPS	COLOR TEMPERATURE
30W	24W	DC 9-32V	2000lm	1860 CSP	6000K

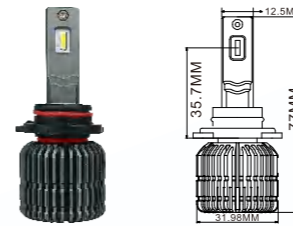

## 9006/9012

START POWER	WORKING POWER	VOLTAGE	LUMEN	LED CHIPS	COLOR TEMPERATURE
30W	24W	DC 9-32V	2000lm	1860 CSP	6000K

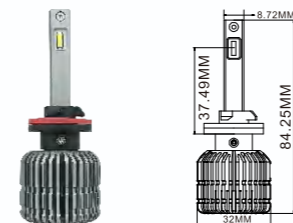

## 880

START POWER	WORKING POWER	VOLTAGE	LUMEN	LED CHIPS	COLOR TEMPERATURE
30W	24W	DC 9-32V	2000lm	1860 CSP	6000K

# LED LIGHTING 5S-K3 SERIES

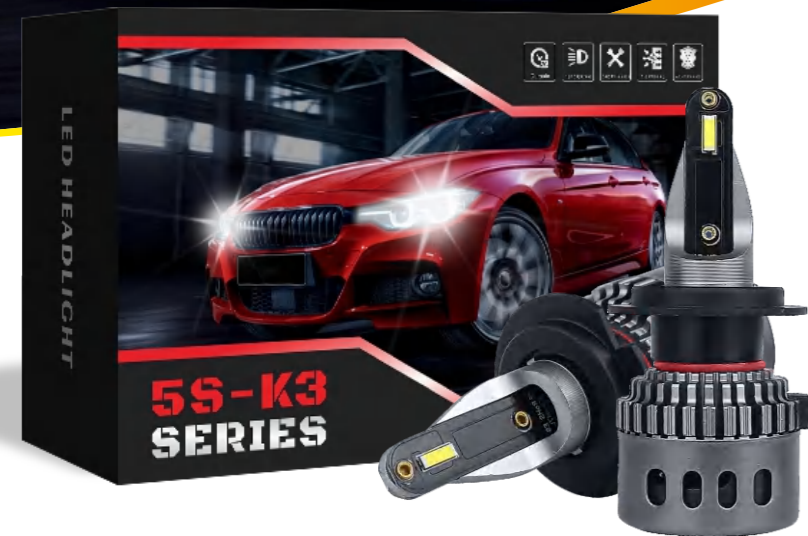

Scan code for products details

**VERY THIN LIGHT TUBE DESIGN, NO GLARING**

**NO EXTERNAL DRIVER**

**SMALL SIZE HOUSING, EASY TO FIT MOST CARS**

**PERFECTLY WORKING ON CAR, TRUCK AND MOTORCYCLE**

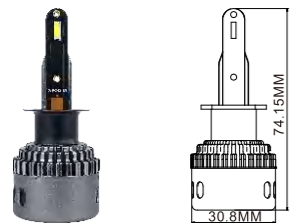

## H1

START POWER	WORKING POWER	VOLTAGE	LUMEN	LED CHIPS	COLOR TEMPERATURE
36W	32W	DC 9-32V	2816lm	1860 CSP	6000K

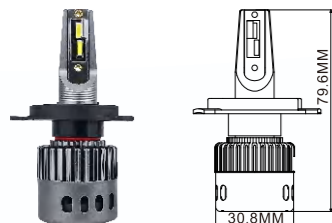

## H4

START POWER	WORKING POWER	VOLTAGE	LUMEN	LED CHIPS	COLOR TEMPERATURE
36W	32W	DC 9-32V	2816lm	1860 CSP	6000K

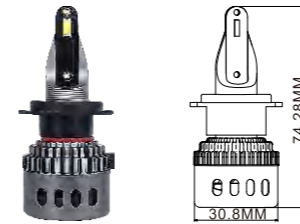

## H7

START POWER	WORKING POWER	VOLTAGE	LUMEN	LED CHIPS	COLOR TEMPERATURE
36W	32W	DC 9-32V	2816lm	1860 CSP	6000K

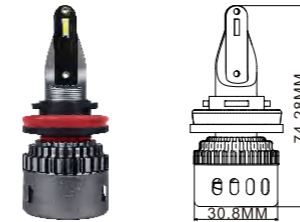

## H8/H9/H11

START POWER	WORKING POWER	VOLTAGE	LUMEN	LED CHIPS	COLOR TEMPERATURE
36W	32W	DC 9-32V	2816lm	1860 CSP	6000K

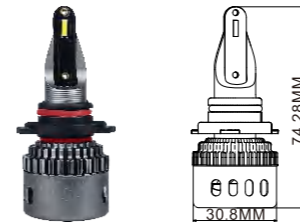

## 9005

START POWER	WORKING POWER	VOLTAGE	LUMEN	LED CHIPS	COLOR TEMPERATURE
36W	32W	DC 9-32V	2816lm	1860 CSP	6000K



## 9006

START POWER	WORKING POWER	VOLTAGE	LUMEN	LED CHIPS	COLOR TEMPERATURE
36W	32W	DC 9-32V	2816lm	1860 CSP	6000K

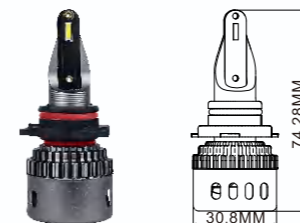

## 9012

START POWER	WORKING POWER	VOLTAGE	LUMEN	LED CHIPS	COLOR TEMPERATURE
36W	32W	DC 9-32V	2816lm	1860 CSP	6000K



LED working lamp  
P/N: NS-RD-35W



CE  
RoHS  
E8

FLOOD + SPOT LIGHT SHAPE  
9-36V DC | 35W | IP68 | 108 x 109 x 81 mm

LED working lamp  
P/N: NS-RD-50W



CE  
RoHS  
E8

FLOOD + SPOT LIGHT SHAPE  
9-36V DC | 50W | IP68 | 108 x 109 x 81 mm

LED working lamp  
P/N: NS-RD-060



CE  
RoHS  
E1

XTRA FLOOD LIGHT SHAPE  
9-36V DC | 60W | IP68 | 155 x 95 x 57 mm

LED working lamp  
P/N: NS-RD-70W



CE  
RoHS  
E1

COMBO FLOOD + SPOT LIGHT SHAPE  
9-36V DC | 70W | IP68 | 165 x 177 x 85 mm

LED working lamp  
P/N: NS-RD-120W



CE  
RoHS  
E1

COMBO FLOOD + SPOT LIGHT SHAPE  
9-36V DC | 120W | IP68 | 246 x 246 x 110 mm

LED working lamp  
P/N: NS-RD-180W



CE  
RoHS  
E1

SPOT+FLOOD+YELLOW/WHITE DUAL COLOR POSITION LIGHT  
10-36V DC | 180W | IP68 | 218 x 218 x 70 mm

LED working lamp  
P/N: NS-WL-00001



CE  
RoHS  
E24

SPOT LIGHT SHAPE  
9-60V DC | 27 W | IP67 | 106 x 106 x 32 mm

LED working lamp  
P/N: NS-WL-00003



CE  
RoHS  
E24

SPOT LIGHT SHAPE  
9-60V DC | 48 W | IP67 | 108 x 108 x 57mm

LED working lamp  
P/N: NS-WL-00002



CE  
RoHS  
E24

SPOT LIGHT SHAPE  
9-60V DC | 27 W | IP67 | Ø115 x 35 mm

LED working lamp  
P/N: NS-WL-00004



CE  
RoHS  
E24

SPOT LIGHT SHAPE  
9-60V DC | 18 W | IP67 | 160 x 43 x 42 mm

LED working lamp  
P/N: NS-WL-00005  
Kabel/Cable 6m



CE  
RoHS  
E24

SPOT LIGHT SHAPE  
9-60V DC | 18 W | IP67 | 111 x 61 x 55 mm

LED working lamp  
P/N: NS-WL-00006



MULTIFUNCTIONAL  
9-36V DC | 50 W | IP67 | 198 x 172 x 60 mm



LED working lamp  
P/N: NS-WL-00007



MULTIFUNCTIONAL  
9-36V DC | 50 W | IP67 | 198 x 172 x 60 mm



LED working lamp  
P/N: NS-WL-00008



MULTIFUNCTIONAL  
9-36V DC | 55 W | IP67 | 170 x 170 x 65 mm



LED working lamp  
P/N: NS-WL-00009



MULTIFUNCTIONAL  
9-36V DC | 60 W | IP67 | 170 x 170 x 65 mm



LED working lamp  
P/N: NS-WL-00010



MULTIFUNCTIONAL  
9-36V DC | 60 W | IP67 | 170 x 170 x 65 mm



LED working lamp  
P/N: NS-WL-00011



FLOOD + SPOT LIGHT + ORANGE CLEARANCE LAMP  
9-36V DC | 45 W | IP67 | 110 x 110 x 35 mm



LED working lamp  
P/N: NS-WL-00012



FLOOD + SPOT LIGHT + ORANGE CLEARANCE LAMP  
9-36V DC | 45 W | IP67 | Ø110 x 35 mm



LED working lamp  
P/N: NS-WL-00013



FLOOD LIGHT SHAPE  
9-36V DC | 27 W | IP67 | Ø110 x 35 mm



LED working lamp  
P/N: NS-WL-00014



COMBO FLOOD + SPOT LIGHT SHAPE  
9-36V DC | 42 W | IP67 | 110 x 110 x 35 mm



LED working lamp  
P/N: NS-WL-00015



COMBO FLOOD + SPOT LIGHT SHAPE  
9-36V DC | 42 W | IP67 | Ø110 x 35 mm



LED working lamp  
P/N: NS-WL-00016



FLOOD LIGHT SHAPE  
9-36V DC | 84 W | IP67 | 136 x 80 x 62 mm



LED working lamp  
P/N: NS-WL-00017



FLOOD LIGHT SHAPE  
9-36V DC | 35 W | IP67 | 110 x 110 x 35 mm



LED working lamp  
P/N: NS-WL-00018



FLOOD LIGHT SHAPE  
9-36V DC | 48 W | IP67 | 110 x 110 x 35 mm



LED working lamp  
P/N: NS-WL-00019



FLOOD LIGHT SHAPE  
9-36V DC | 27 W | IP67 | 110 x 110 x 35 mm



LED working lamp  
P/N: NS-WL-00020



COMBO FLOOD + SPOT LIGHT SHAPE  
9-36V DC | 45 W | IP67 | 160 x 90 x 70 mm



LED working lamp  
P/N: NS-WL-00021



COMBO FLOOD + SPOT LIGHT SHAPE  
9-36V DC | 45 W | IP67 | 110 x 99 x 52 mm



LED working lamp  
P/N: NS-WL-00022



FLOOD LIGHT SHAPE  
9-36V DC | 45 W | IP67 | 110 x 110 x 52 mm



LED working lamp  
P/N: NS-WL-00023



COMBO FLOOD + SPOT LIGHT SHAPE  
9-36V DC | 36 W | IP67 | 110 x 75 x 60 mm



LED working lamp  
P/N: NS-WL-00024



FLOOD LIGHT SHAPE  
9-36V DC | 18 W | IP67 | 95 x 77 x 65 mm



LED working lamp  
P/N: NS-WL-00025



SPOT LIGHT SHAPE  
9-36V DC | 10 W | IP67 | 50 x 50 x 60 mm



LED working lamp  
P/N: NS-WL-00026



2 FUNCTIONS - SPOT LIGHT SHAPE  
9-36V DC | 54 W | IP67 | 110 x 80 x 60 mm



LED working lamp  
P/N: NS-WL-00027



3 FUNCTIONS - FLOOD LIGHT SHAPE  
9-36V DC | 81 W | IP67 | 225 x 110 x 60 mm



LED working lamp  
P/N: NS-WL-00028



CE  
RoHS  
E24

LED working lamp  
P/N: NS-WL-00029



CE  
RoHS  
E24

2 FUNCTIONS - SPOT LIGHT SHAPE  
9-36V DC | 150 W | IP67 | 170 x 110 x 60 mm

LED working lamp  
P/N: NS-WL-00030



CE  
RoHS  
E24

2 FUNCTIONS - SPOT LIGHT SHAPE  
9-36V DC | 171 W | IP67 | 230 x 110 x 60 mm

LED working lamp  
P/N: NS-WL-00031



CE  
RoHS  
E24

2 FUNCTIONS - SPOT LIGHT SHAPE  
9-36V DC | 108 W | IP67 | 150 x 95 x 60 mm

LED working lamp  
P/N: NS-WL-00032



CE  
RoHS  
E24

FLOOD LIGHT SHAPE  
9-36V DC | 90 W | IP67 | 110 x 110 x 45 mm

LED working lamp with switch  
P/N: NS-WL-00033



CE  
RoHS  
E24

FLOOD LIGHT SHAPE  
9-36V DC | 90 W | IP67 | 110 x 110 x 42 mm

LED working lamp  
P/N: NS-WL-00034



CE  
RoHS  
E24

COMBO FLOOD + SPOT LIGHT SHAPE  
9-36V DC | 72 W | IP67 | 135 x 75 x 55 mm

LED working lamp  
P/N: NS-WL-00035



CE  
RoHS  
E24

SPOT LIGHT SHAPE  
9-36V DC | 60 W | IP67 | 95 x 74 x 55 mm

LED working lamp  
P/N: NS-WL-00036



CE  
RoHS  
E24

2 FUNCTIONS - SPOT LIGHT SHAPE  
9-36V DC | 144 W | IP67 | 110 x 110 x 35 mm

LED driving lamp  
P/N: NS-WL-00041



CE  
RoHS  
E24

FLOOD LIGHT SHAPE  
9-50V DC | 10W | IP67 | 77x77x67mm

LED driving lamp  
P/N: NS-WL-00042



CE  
RoHS  
E24

FLOOD LIGHT SHAPE  
9-50V DC | 15W | IP67 | 77x77x67mm

LED driving lamp  
P/N: NS-WL-00043



CE  
RoHS  
E24

FLOOD LIGHT SHAPE  
9-50V DC | 40W | IP67 | 77x77x67mm

LED driving lamp  
P/N: NS-WL-00044



CE  
RoHS  
E24

FLOOD LIGHT SHAPE  
9-50V DC | 13W+13W | Yellow+White | IP67 | 102x65x66mm

LED driving lamp  
P/N: NS-WL-00045



CE  
RoHS  
E24

FLOOD LIGHT SHAPE  
9-50V DC | 13W | White | IP67 | 102x65x66mm

LED driving lamp  
P/N: NS-WL-00046



CE  
RoHS  
E24

FLOOD LIGHT SHAPE  
9-50V DC | 13W+13W | Yellow+White | IP67 | 67.5x72.5mm

LED driving lamp  
P/N: NS-WL-00047



CE  
RoHS  
E24

FLOOD LIGHT SHAPE  
9-50V DC | 18W+18W | Yellow+White | IP67 | 95x35mm

LED driving lamp  
P/N: NS-WL-00048



CE  
RoHS  
E24

FLOOD LIGHT SHAPE  
9-50V DC | 24W+24W | Yellow+White | IP67 | 127x35mm

LED driving lamp  
P/N: NS-WL-00049



CE  
RoHS  
E24

FLOOD LIGHT SHAPE  
9-50V DC | IP67 | Φ180mm  
30W high beam +15W low beam

LED driving lamp  
P/N: NS-WL-00050



CE  
RoHS  
E24

FLOOD LIGHT SHAPE  
9-50V DC | IP67 | Φ180mm  
30W high beam +15W low beam

LED driving lamp  
P/N: NS-WL-00051



CE  
RoHS  
E24

FLOOD LIGHT SHAPE  
9-50V DC | IP67 | Φ180mm  
30W high beam +15W low beam

LED light bar

- P/N: **NS-WL-1R4** 20W | 4"
- P/N: **NS-WL-1R6** 30W | 6"
- P/N: **NS-WL-1R10** 50W | 10"
- P/N: **NS-WL-1R20** 100W | 20"
- P/N: **NS-WL-1R30** 150W | 30"
- P/N: **NS-WL-1R40** 200W | 40"
- P/N: **NS-WL-1R50** 250W | 50"



SPOT | FLOOD | COMBO LIGHT SHAPE  
9-32V DC | IP68

LED light bar

- P/N: **NS-WL-2R4** 24W | 4"
- P/N: **NS-WL-2R6** 36W | 6"
- P/N: **NS-WL-2R10** 60W | 10"
- P/N: **NS-WL-2R20** 120W | 20"
- P/N: **NS-WL-2R30** 180W | 30"
- P/N: **NS-WL-2R40** 240W | 40"
- P/N: **NS-WL-2R50** 300W | 50"



SPOT | FLOOD | COMBO LIGHT SHAPE  
9-32V DC | IP68

LED light bar

- P/N: **NS-LB-1R10** 40W | 10"
- P/N: **NS-LB-1R20** 80W | 20"
- P/N: **NS-LB-1R26** 120W | 26"
- P/N: **NS-LB-1R35** 160W | 35"
- P/N: **NS-LB-1R43** 200W | 43"



SPOT | FLOOD | COMBO LIGHT SHAPE  
9-32V DC | IP68

LED light bar

- P/N: **NS-WL-00037** 120 W | 170 x 74 x 63 mm
- P/N: **NS-WL-00037** 180 W | 240 x 74 x 63 mm
- P/N: **NS-WL-00037** 240 W | 300 x 74 x 63 mm
- P/N: **NS-WL-00037** 360 W | 450 x 74 x 63 mm
- P/N: **NS-WL-00037** 420 W | 520 x 74 x 63 mm
- P/N: **NS-WL-00037** 540 W | 650 x 74 x 63 mm
- P/N: **NS-WL-00037** 600 W | 720 x 74 x 63 mm
- P/N: **NS-WL-00037** 660 W | 800 x 74 x 63 mm



COMBO FLOOD + SPOT LIGHT SHAPE  
9-36V DC | IP67

LED light bar

- P/N: **NS-WL-00038** 72 W | 402 x 90 x 80 mm
- P/N: **NS-WL-00038** 120 W | 606 x 90 x 80 mm
- P/N: **NS-WL-00038** 180 W | 869 x 90 x 80 mm
- P/N: **NS-WL-00038** 240 W | 1132 x 90 x 80 mm



COMBO FLOOD + SPOT LIGHT SHAPE  
9-36V DC | IP67

Curved LED light bar

- P/N: **NS-WL-00039** 324 W | 520 x 80 x 84 mm
- P/N: **NS-WL-00039** 459 W | 800 x 80 x 84 mm
- P/N: **NS-WL-00039** 594 W | 1000 x 80 x 84 mm
- P/N: **NS-WL-00039** 729 W | 1300 x 80 x 84 mm



COMBO FLOOD + SPOT LIGHT SHAPE  
9-36V DC | IP67

LED light bar

- P/N: **NS-WL-00040** 18 SMD | max. 54 W | 80 x 27x43 mm
- P/N: **NS-WL-00040** 36 SMD | max. 108 W | 340 x 27x43 mm
- P/N: **NS-WL-00040** 54 SMD | max. 162 W | 500 x 27x43 mm
- P/N: **NS-WL-00040** 72 SMD | max. 216 W | 653 x 27x43 mm
- P/N: **NS-WL-00040** 90 SMD | max. 270 W | 810 x 27x43 mm
- P/N: **NS-WL-00040** 108 SMD | max. 324 W | 965 x 27x43 mm
- P/N: **NS-WL-00040** 126 SMD | max. 378 W | 1120 x 27x43 mm
- P/N: **NS-WL-00040** 144 SMD | max. 432 W | 1275 x 27 x 43 mm



SPOT LIGHT SHAPE  
9-36V DC | IP67

5S-X9 SERIES

# LED LIGHTING 5S-X9 SERIES

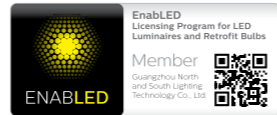

Scan code for products details

**INTEGRATED CPU CORE COOLING SYSTEM**  
(HEAT PIPE+FINS+FAN THERMAL)

**STEADY WORKING POWER:**  
FULL 51 WATT

**REAL 1:1 DESIGN AS HALOGEN BULB**

**500% BRIGHTER**  
FOCUSED BEAM PATTERN

**FITS FOR 98% VEHICLES**



**HEAT PIPE+FINS**

10 times heat dissipation area

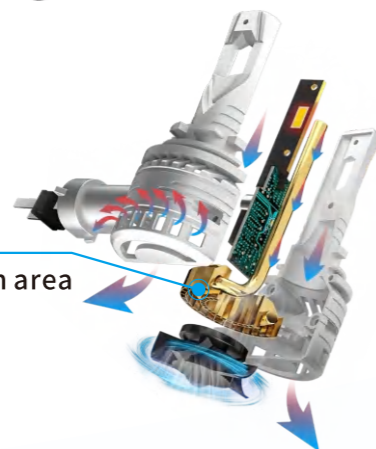

**China Patent:**  
202310801\*\*\*.4  
202321710\*\*\*.7

**U. S. Patent:**  
1836\*\*\*8

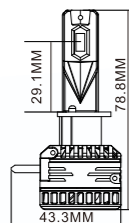

## H1

START POWER	WORKING POWER	VOLTAGE	LUMEN	LED CHIPS	COLOR TEMPERATURE
56W	51W	DC 9-48V	4218lm	2*3570 CSP	6000K

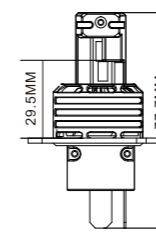

## H4

START POWER	WORKING POWER	VOLTAGE	LUMEN	LED CHIPS	COLOR TEMPERATURE
55.8W(hi)/56W(lo)	50.3W(hi)/51W(lo)	DC 9-48V	4453lm	4*3570 CSP	6000K

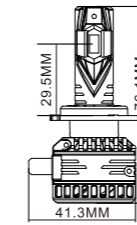

## H7

START POWER	WORKING POWER	VOLTAGE	LUMEN	LED CHIPS	COLOR TEMPERATURE
56W	51W	DC 9-48V	4500lm	2*3570 CSP	6000K

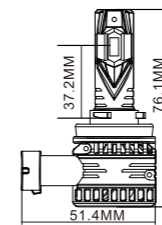

## H8/H9/H11

START POWER	WORKING POWER	VOLTAGE	LUMEN	LED CHIPS	COLOR TEMPERATURE
56W	51W	DC 9-48V	4453lm	2*3570 CSP	6000K

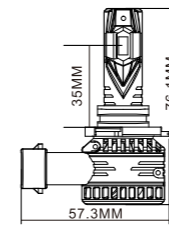

## 9005/9006/9012

START POWER	WORKING POWER	VOLTAGE	LUMEN	LED CHIPS	COLOR TEMPERATURE
56W	51W	DC 9-48V	4560lm	2*3570 CSP	6000K

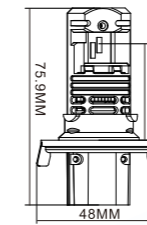

## H13

START POWER	WORKING POWER	VOLTAGE	LUMEN	LED CHIPS	COLOR TEMPERATURE
55.8W(hi)/56W(lo)	50.3W(hi)/51W(lo)	DC 9-48V	4449lm	4*3570 CSP	6000K

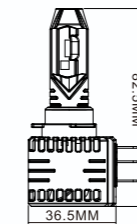

## H15

START POWER	WORKING POWER	VOLTAGE	LUMEN	LED CHIPS	COLOR TEMPERATURE
55.8W(hi)/56W(lo)	50.3W(hi)/51W(lo)	DC 9-48V	4449lm	2*3570 CSP 2*1515 CSP	6000K

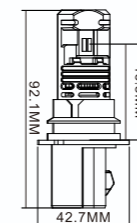

## 9007

START POWER	WORKING POWER	VOLTAGE	LUMEN	LED CHIPS	COLOR TEMPERATURE
55.8W(hi)/56W(lo)	50.3W(hi)/51W(lo)	DC 9-48V	4500lm	4*3570 CSP	6000K

# LED LIGHTING 5S-NH SERIES

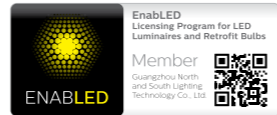

Scan code for products details

1:1 SAME BEAM PATTERN AS HALOGEN BULB

PLUG & PLAY INSTALLATION

NO ADDITIONAL ADAPTER REQUIRED

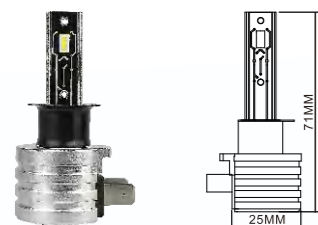
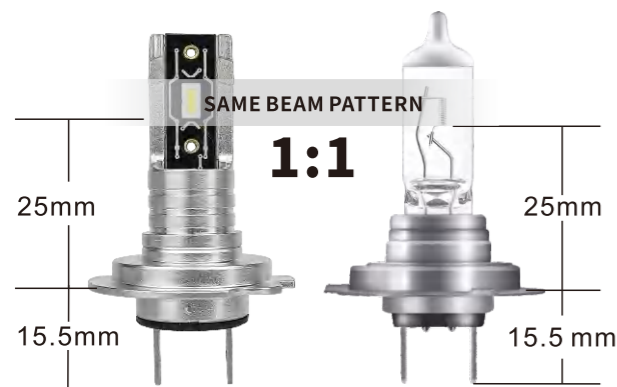

## H1 4000K/6000K

POWER	VOLTAGE	LUMEN	LED CHIPS	MATERIAL
25W	DC 9-32V	1986lm	2*5530 CSP	AL 6063

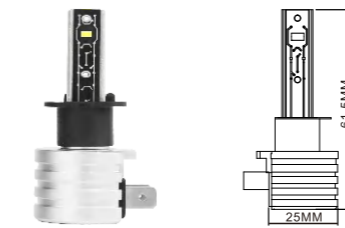

## H3 4000K/6000K

POWER	VOLTAGE	LUMEN	LED CHIPS	MATERIAL
25W	DC 9-32V	1986lm	2*5530 CSP	AL 6063

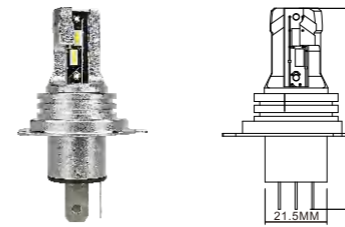

## H4 4000K/6000K

POWER	VOLTAGE	LUMEN	LED CHIPS	MATERIAL
25W	DC 9-32V	1986lm	4*5530 CSP	AL 6063

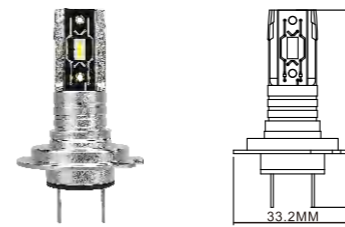

## H7 4000K/6000K

POWER	VOLTAGE	LUMEN	LED CHIPS	MATERIAL
25W	DC 9-32V	1986lm	2*5530 CSP	AL 6063

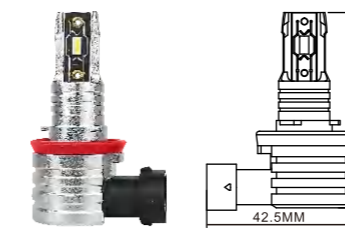

## H8/H9/H11 4000K/6000K

POWER	VOLTAGE	LUMEN	LED CHIPS	MATERIAL
25W	DC 9-32V	1986lm	2*5530 CSP	AL 6063

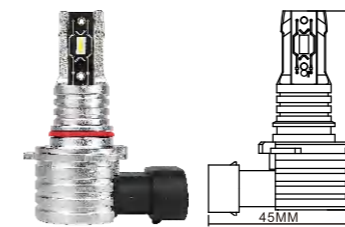

## 9005 4000K/6000K

POWER	VOLTAGE	LUMEN	LED CHIPS	MATERIAL
25W	DC 9-32V	1986lm	2*5530 CSP	AL 6063

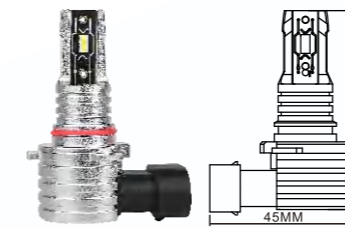

## 9006 4000K/6000K

POWER	VOLTAGE	LUMEN	LED CHIPS	MATERIAL
25W	DC 9-32V	1986lm	2*5530 CSP	AL 6063

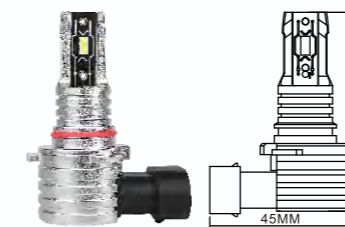

## 9012 4000K/6000K

POWER	VOLTAGE	LUMEN	LED CHIPS	MATERIAL
25W	DC 9-32V	1986lm	2*5530 CSP	AL 6063

# LED LIGHTING 5S-D SERIES

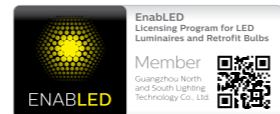

Scan code for products details



*Cost 50% less*

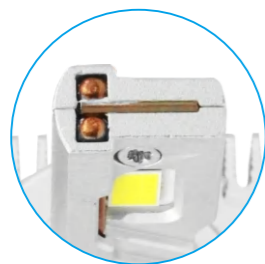

DUAL HEAT PIPE COOLING



**PERFECT BEAM PATTERN**  
Ensure wider and further light area. No glare on coming drivers.

SAME FOCUS  
**1:1**



## D1C/D1S/D1R

POWER	VOLTAGE	LUMEN	LED CHIPS	COLOR TEMPERATURE	MATERIAL
50W	DC 87±3V	4500lm	2*4575 CSP	6000K	AL 6063

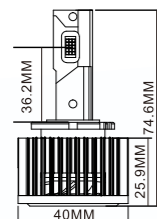

## D2C/D2S/D2R

POWER	VOLTAGE	LUMEN	LED CHIPS	COLOR TEMPERATURE	MATERIAL
50W	DC 87±3V	4500lm	2*4575 CSP	6000K	AL 6063

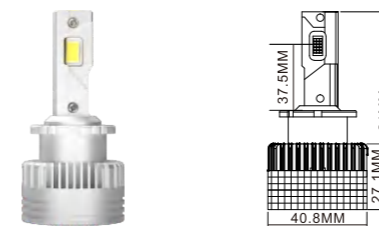

## D3C/D3S/D3R

POWER	VOLTAGE	LUMEN	LED CHIPS	COLOR TEMPERATURE	MATERIAL
50W	DC 44±3V	4500lm	2*4575 CSP	6000K	AL 6063

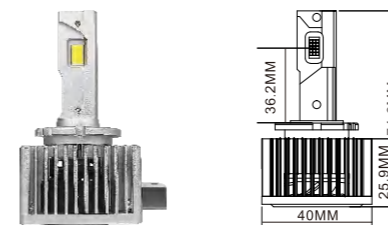

## D4C/D4S/D4R

POWER	VOLTAGE	LUMEN	LED CHIPS	COLOR TEMPERATURE	MATERIAL
50W	DC 44±3V	4500lm	2*4575 CSP	6000K	AL 6063

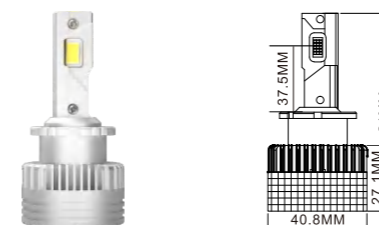

## D8S

POWER	VOLTAGE	LUMEN	LED CHIPS	COLOR TEMPERATURE	MATERIAL
50W	DC 44±3V	4500lm	2*4575 CSP	6000K	AL 6063

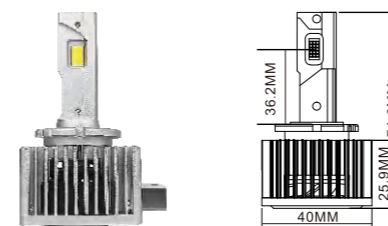

## D5S

POWER	VOLTAGE	LUMEN	LED CHIPS	COLOR TEMPERATURE	MATERIAL
35W	DC 12/24V	4500lm	2*3570 CSP	6000K	AL 6063

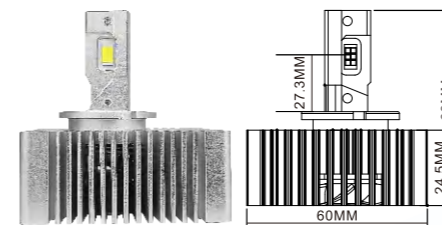

**D1K** D1K 12/24V LED Headlight bulb  
NSSC D1K lamp = ballast+hid bulb

POWER	VOLTAGE	LUMEN	LED CHIPS	COLOR TEMPERATURE	MATERIAL
50W	DC 12/24V	4500lm	2*4575 CSP	6000K	AL 6063

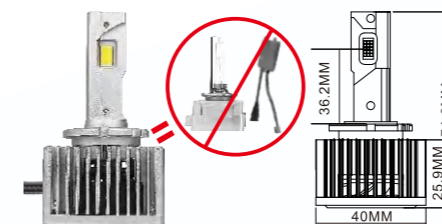

**D2K** D2K 12/24V LED Headlight bulb  
NSSC D2K lamp = ballast+hid bulb

POWER	VOLTAGE	LUMEN	LED CHIPS	COLOR TEMPERATURE	MATERIAL
50W	DC 12/24V	4500lm	2*4575 CSP	6000K	AL 6063





# LED LIGHTING 5S-Z3 SERIES

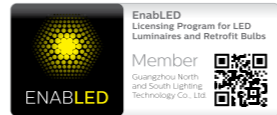

Scan code for products details



**DUAL HEAT PIPE COOLING**

**STABLE AT 50W, 4200LM AFTER 2 HRS AGING**

**NON-POLARITY**

**WIDE RANGE 9-48V, FOR CAR & TRUCK & MOTOR**

Heat pipe--300 Times heat conduction than copper

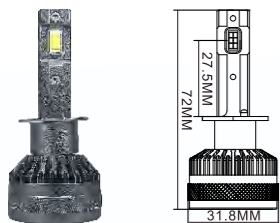

## H1 4000K/6000K

START POWER	WORKING POWER	VOLTAGE	STABLE LUMEN	LED CHIPS	MATERIAL
62W	50W	DC 9-48V	4469lm	2*3570 CSP	AL 6063

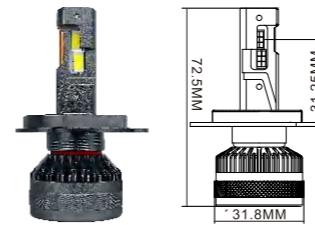

## H4 4000K/6000K

START POWER	WORKING POWER	VOLTAGE	STABLE LUMEN	LED CHIPS	MATERIAL
63W	50W	DC 9-48V	4476lm	4*3570 CSP	AL 6063

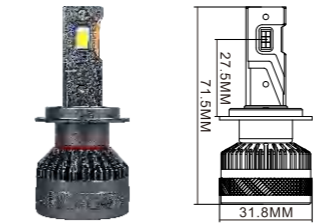

## H7 4000K/6000K

START POWER	WORKING POWER	VOLTAGE	STABLE LUMEN	LED CHIPS	MATERIAL
65W	50W	DC 9-48V	4512lm	2*3570 CSP	AL 6063

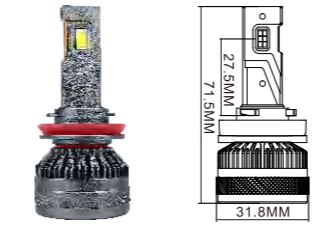

## H8/H9/H11 4000K/6000K

START POWER	WORKING POWER	VOLTAGE	STABLE LUMEN	LED CHIPS	MATERIAL
65W	50W	DC 9-48V	4542lm	2*3570 CSP	AL 6063

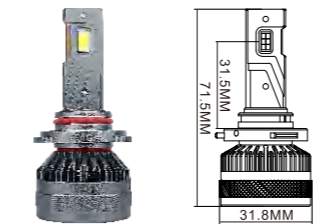

## 9005 4000K/6000K

START POWER	WORKING POWER	VOLTAGE	STABLE LUMEN	LED CHIPS	MATERIAL
65W	50W	DC 9-48V	4599lm	2*3570 CSP	AL 6063

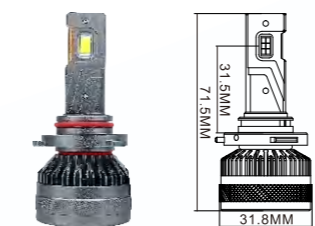

## 9006 4000K/6000K

START POWER	WORKING POWER	VOLTAGE	STABLE LUMEN	LED CHIPS	MATERIAL
65W	50W	DC 9-48V	4599lm	2*3570 CSP	AL 6063

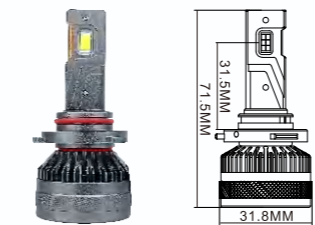

## 9012 4000K/6000K

START POWER	WORKING POWER	VOLTAGE	STABLE LUMEN	LED CHIPS	MATERIAL
65W	50W	DC 9-48V	4599lm	2*3570 CSP	AL 6063



5S-Z6 SERIES



LED LIGHTING  
5S-Z6 SERIES

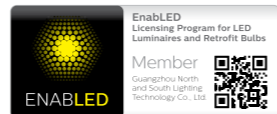

Scan code for products details



FANLESS FOR LONG LIFESPAN

STEADY QUALITY, LOWEST DEFECTIVE RATE

INSTANTLY ACTIVATE TO MAXIMUM BRIGHTNESS  
PERFECT CUT-OFF LINE BEAM, FOR SAFER DRIVING

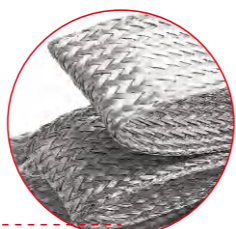

6 pcs 180mm flexible copper belts, for bigger heatsink area

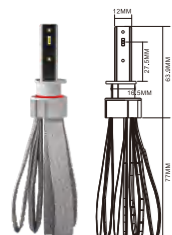

Z6-H1

POWER	VOLTAGE	LUMEN	LED CHIPS	MATERIAL	COLOR TEMPERATURE
21.6W	DC 9-32V	1922.4lm	2*1860CSP	AL6063 Pure Copper belts	6000K

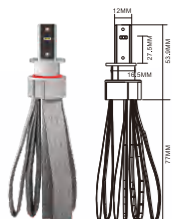

Z6-H3

POWER	VOLTAGE	LUMEN	LED CHIPS	MATERIAL	COLOR TEMPERATURE
20.6W	DC 9-32V	1890.4lm	2*1860CSP	AL6063 Pure Copper belts	6000K

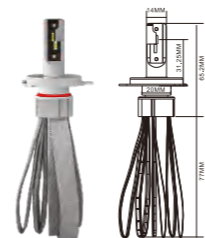

Z6-H4

POWER	VOLTAGE	LUMEN	LED CHIPS	MATERIAL	COLOR TEMPERATURE
23.6W(hi)/22.8W(lo)	DC 9-32V	2023 (hi) 1957lm (lo)	4*1860CSP	AL6063 Pure Copper belts	6000K



Z6-H7

POWER	VOLTAGE	LUMEN	LED CHIPS	MATERIAL	COLOR TEMPERATURE
25W	DC 9-32V	2105lm	2*1860CSP	AL6063 Pure Copper belts	6000K

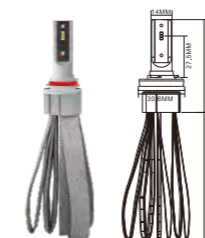

Z6-H8/H9/H11

POWER	VOLTAGE	LUMEN	LED CHIPS	MATERIAL	COLOR TEMPERATURE
24.9W	DC 9-32V	2099lm	2*1860CSP	AL6063 Pure Copper belts	6000K

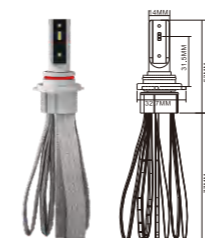

Z6-9005

POWER	VOLTAGE	LUMEN	LED CHIPS	MATERIAL	COLOR TEMPERATURE
24.7W	DC 9-32V	2182lm	2*1860CSP	AL6063 Pure Copper belts	6000K

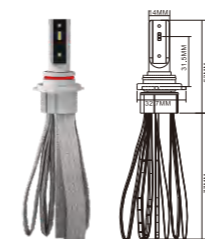

Z6-9006

POWER	VOLTAGE	LUMEN	LED CHIPS	MATERIAL	COLOR TEMPERATURE
25W	DC 9-32V	2105lm	2*1860CSP	AL6063 Pure Copper belts	6000K

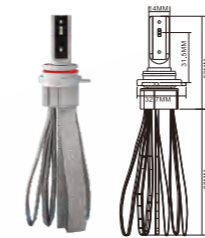

Z6-9012

POWER	VOLTAGE	LUMEN	LED CHIPS	MATERIAL	COLOR TEMPERATURE
25W	DC 9-32V	2105lm	2*1860CSP	AL6063 Pure Copper belts	6000K



Z6-H15 White +White(DRL) /White+Amber(DRL)

POWER	VOLTAGE	LUMEN	LED CHIPS	MATERIAL	COLOR TEMPERATURE
25W	DC 9-32V	2105lm	2*1860CSP	AL6063 Pure Copper belts	6000K

LED HEADLIGHT

5S-K2 SERIES

# LED LIGHTING 5S-K2 SERIES

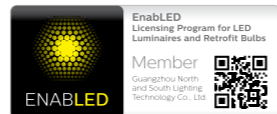

Scan code for products details

25W FULL POWER OUTPUT

INTEGRATED ELECTRONICS,  
NO EXTERNAL DRIVERS

COMPACT ALL-IN-ONE DESIGN  
FOR PLUG-AND-PLAY USE

VOLTAGE: 9-32V

EXCELLENT COOLING VIA  
EFFECTIVE ACTIVE FAN

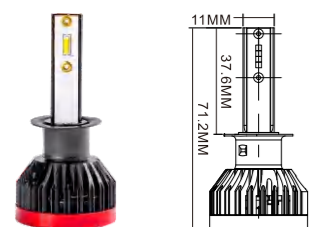

## H1

POWER	VOLTAGE	LED CHIPS	MATERIAL	COLOR TEMPERATURE
25W	DC 9-32V	2*1860 CSP	AL 6063	6000K

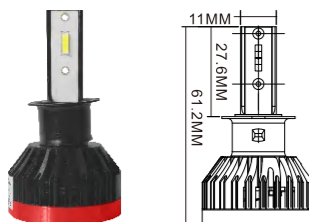

## H3

POWER	VOLTAGE	LED CHIPS	MATERIAL	COLOR TEMPERATURE
25W	DC 9-32V	2*1860 CSP	AL 6063	6000K

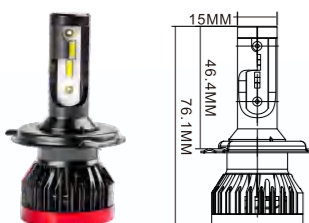

## H4

POWER	VOLTAGE	LED CHIPS	MATERIAL	COLOR TEMPERATURE
25W	DC 9-32V	4*1860 CSP	AL 6063	6000K

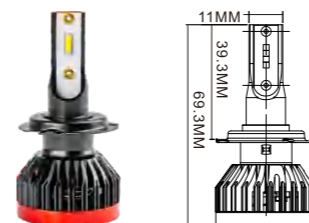

## H7

POWER	VOLTAGE	LED CHIPS	MATERIAL	COLOR TEMPERATURE
25W	DC 9-32V	2*1860 CSP	AL 6063	6000K



## H8/H9/H10/H11

POWER	VOLTAGE	LED CHIPS	MATERIAL	COLOR TEMPERATURE
25W	DC 9-32V	2*1860 CSP	AL 6063	6000K

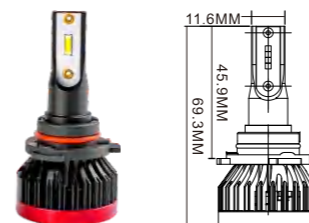

## 9005

POWER	VOLTAGE	LED CHIPS	MATERIAL	COLOR TEMPERATURE
25W	DC 9-32V	2*1860 CSP	AL 6063	6000K



## 9006

POWER	VOLTAGE	LED CHIPS	MATERIAL	COLOR TEMPERATURE
25W	DC 9-32V	2*1860 CSP	AL 6063	6000K



## 5202

POWER	VOLTAGE	LED CHIPS	MATERIAL	COLOR TEMPERATURE
25W	DC 9-32V	2*1860 CSP	AL 6063	6000K



## 9012

POWER	VOLTAGE	LED CHIPS	MATERIAL	COLOR TEMPERATURE
25W	DC 9-32V	2*1860 CSP	AL 6063	6000K

# LED LIGHTING 5S-Z6L19 SERIES

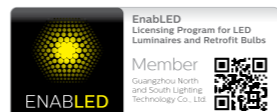

Scan code for products details



WITH PERFECT HIGH/LOW BEAM, NO BLIND ON COMING CARS

SHORTER AND WITH SMALLER DIAMETER LENS, EASIER TO INSTALL AND SUIT FOR 98% CARS

CANBUS, NO ERROR

FANLESS, 6 PCS 180MM FLEXIBLE COPPER BELTS, FOR BIGGER HEATSINK AREA, FOR LONG LIFESPAN



SMALLER DIAMETER LENS

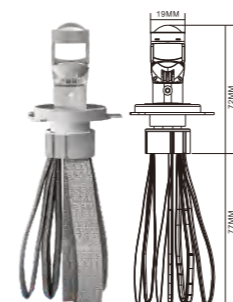
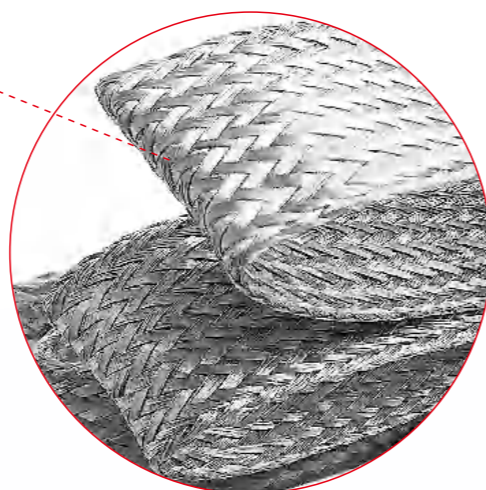

## Z6L-H4

POWER	VOLTAGE	LUMEN	LED CHIPS	LENS DIAMETER	MATERIAL	COLOR TEMPERATURE
19.2 (hi) / 18.9W (lo)	DC 9-32V	1238lm (hi) / 1192 (lo)	4*3570CSP	19mm	AL6063 Pure Copper belts	6000K

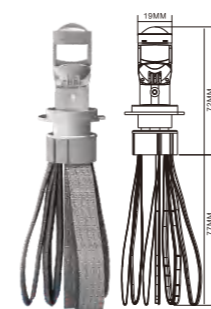

## Z6L-H7

POWER	VOLTAGE	LUMEN	LED CHIPS	LENS DIAMETER	MATERIAL	COLOR TEMPERATURE
20W	DC 9-32V	1300lm	2*3570CSP	19mm	AL6063 Pure Copper belts	6000K

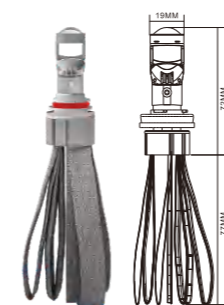

## Z6L-H8/H9/H11

POWER	VOLTAGE	LUMEN	LED CHIPS	LENS DIAMETER	MATERIAL	COLOR TEMPERATURE
21W	DC 9-32V	1380lm	2*3570CSP	19mm	AL6063 Pure Copper belts	6000K

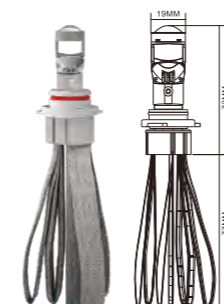

## Z6L-9005

POWER	VOLTAGE	LUMEN	LED CHIPS	LENS DIAMETER	MATERIAL	COLOR TEMPERATURE
20.7W	DC 9-32V	1310lm	2*3570CSP	19mm	AL6063 Pure Copper belts	6000K

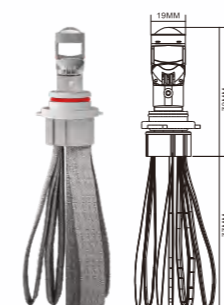

## Z6L-9006

POWER	VOLTAGE	LUMEN	LED CHIPS	LENS DIAMETER	MATERIAL	COLOR TEMPERATURE
20.7W	DC 9-32V	1310lm	2*3570CSP	19mm	AL6063 Pure Copper belts	6000K

5S-NL19 SERIES

# LED LIGHTING 5S-NL19 SERIES



Scan code for products details



**SAME BEAM AS HALOGEN BULB .**

**WITH PERFECT HIGH/LOW BEAM, NO BLIND ON COMING CARS**

**ULTRA-FAST START UP 0.1 SECOND**

**SHORTER AND WITH SMALLER DIAMETER LENS, EASIER TO INSTALL AND SUIT FOR MOST CARS .**

**CANBUS ERROR FREE**

**SMALLER DIAMETER LENS**



**PERFECT HIGH/LOW BEAM**

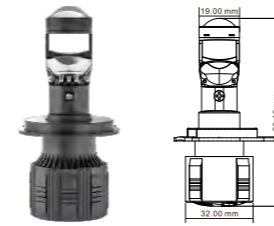

## 5S-NL-19 H4

START POWER	WORKING POWER	VOLTAGE	LENS DIAMETER	LED CHIPS	COLOR TEMPERATURE
36W	32W	DC 9-36V	19mm	4*3570 CSP	6000K

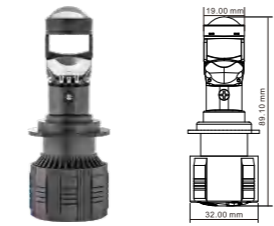

## 5S-NL-19 H7

START POWER	WORKING POWER	VOLTAGE	LENS DIAMETER	LED CHIPS	COLOR TEMPERATURE
36W	32W	DC 9-36V	19mm	2*3570 CSP	6000K

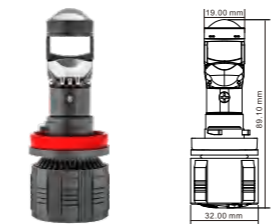

## 5S-NL-19 H8/H9/H11

START POWER	WORKING POWER	VOLTAGE	LENS DIAMETER	LED CHIPS	COLOR TEMPERATURE
36W	32W	DC 9-36V	19mm	2*3570 CSP	6000K

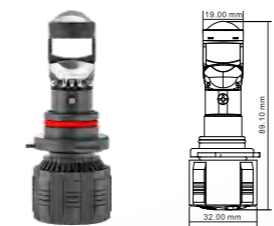

## 5S-NL-19 9005

START POWER	WORKING POWER	VOLTAGE	LENS DIAMETER	LED CHIPS	COLOR TEMPERATURE
36W	32W	DC 9-36V	19mm	2*3570 CSP	6000K

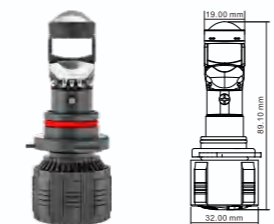

## 5S-NL-19 9006

START POWER	WORKING POWER	VOLTAGE	LENS DIAMETER	LED CHIPS	COLOR TEMPERATURE
36W	32W	DC 9-36V	19mm	2*3570 CSP	6000K

# LED PROJECTOR LENS LIGHT

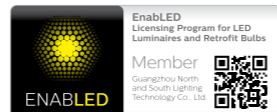

Scan code for products details



- AVAILABLE IN 1.5 INCH, 2.5 INCH, 3 INCH LENS HEADLIGHT
- HIGH COLOR RENDERING INDEX, CRI>90%
- MAXIMUM BRIGHTNESS IN THE AREA OF THE BLACK-AND-WHITE BORDER, NO GLARE FROM THE NEAR ZONE.
- SOFT DRIVING BOUNDARY LINES, NOT TIRED AFTER LONG TIME DRIVING



## NS-PL-14-2.5 (2.5inch)

POWER	LENS SIZE	VOLTAGE	LUMEN	COLOR TEMPERATURE
40W lo/50W hi	2.5 INCH	DC 9-16V	5900 lo/6700 hi	6000K



## NS-PL-02

POWER	LENS SIZE	VOLTAGE	LUMEN	COLOR TEMPERATURE
40W lo/50W hi	3 INCH	DC 9-16V	6290 lo/7700 hi	6000K



## NS-PL-B17 (lens with blue coating glass)

POWER	LENS SIZE	VOLTAGE	LUMEN	COLOR TEMPERATURE
40W lo/50W hi	3 INCH	DC 9-16V	9890 lo/11000 hi	6000K



## NS-BPL-01

POWER	LENS SIZE	VOLTAGE	LUMEN	COLOR TEMPERATURE
50W lo/60W hi	3 INCH	DC 9-16V	5390 lo/5750 hi	6000K



## NS-BPL-03

POWER	LENS SIZE	VOLTAGE	LUMEN	COLOR TEMPERATURE
48W lo/60W hi	3 INCH	DC 9-16V	4330 lo/6050 hi	6000K



## NS-BPL-05

POWER	LENS SIZE	VOLTAGE	LUMEN	COLOR TEMPERATURE
50W lo/60W hi	3 INCH	DC 9-16V	6100 lo/7000 hi	6000K



## NS-BPL-10

POWER	LENS SIZE	VOLTAGE	LUMEN	COLOR TEMPERATURE
42W lo/55W hi	3 INCH	DC 9-16V	5124 lo/6710 hi	6000K



**NS-BPL-11**

POWER	LENS SIZE	VOLTAGE	LUMEN	COLOR TEMPERATURE
52W lo/61W hi	3 INCH	DC 9-16V	6344 lo/7442 hi	6000K



**NS-LBPL-04 (BI-LED projector Lens with laser)**

POWER	LENS SIZE	VOLTAGE	LUMEN	COLOR TEMPERATURE
45W lo/55W hi	3 INCH	DC 9-16V	5750 lo/6500 hi	6000K



**NS-LBPL-08 (BI-LED projector Lens with laser)**

POWER	LENS SIZE	VOLTAGE	LUMEN	COLOR TEMPERATURE
55W lo/65W hi/ 80W hi+laser	3 INCH	DC 9-16V	6500 lo/6000 hi/ 1230lm hi+laser	6000K



**NS-MBPL-07 (1.5 INCH BI-LED Projector Lens)**

POWER	LENS SIZE	VOLTAGE	LUMEN	COLOR TEMPERATURE
40W lo/50W hi	1.5 INCH	DC 9-16V	5900 lo/6700 hi/	6000K



**NS-MBPL-12 (1.5 INCH BI-LED projector lens)**

POWER	LENS SIZE	VOLTAGE	LUMEN	COLOR TEMPERATURE
40W lo/35W hi	1.5 INCH	DC 9-16V	3660 lo/4270 hi	6000K



**NS-HPL-13 (High Beam)**

POWER	LENS SIZE	VOLTAGE	LUMEN	COLOR TEMPERATURE
30W/PCS	1.5 INCH	DC 9-16V	3000lm	6000K



**NS-HPL-15 (High Beam)**

POWER	LENS SIZE	VOLTAGE	LUMEN	COLOR TEMPERATURE
35W/pcs	1.5 INCH	DC 9-16V	3500lm	6000K



**NS-HPL-15L (High Beam)**

POWER	LENS SIZE	VOLTAGE	LUMEN	COLOR TEMPERATURE
19W /pcs	1.5 INCH	DC 9-16V	3500lm	6000K





# BI-LED PROJECTOR LENS FOG LAMP

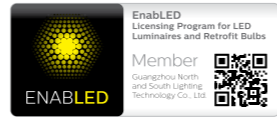

Scan code for products details

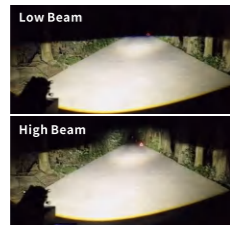
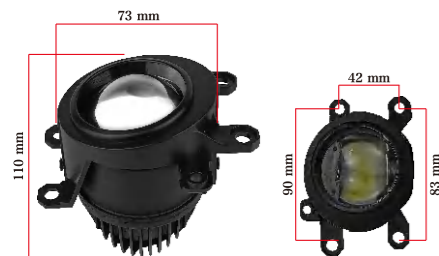

## 2 INCH

POWER	LENS SIZE	VOLTAGE	COLOR TEMPERATURE
30W (lo) / 42W (hi)	2 INCH	12V	6000K
<b>FITMENT</b>			
Corolla Cross; Vios 2021; Corolla Sport Hatchback; Highlander XSE; Prius C2017 - UP; C-Hr2020 - UP; Yaris 2020 - 2021; Sienta 2020 - UP; Altis 2020 - UP; Hilux REVO 2020; Camry 2021; Fortuner 2020 - UP; Camry 2021; Fortuner 2020 - UP; Lexus Nx260 / 350H; Lexus UX 300e			



## 3 INCH

POWER	LENS SIZE	VOLTAGE	COLOR TEMPERATURE
30W (lo) / 42W (hi)	3 INCH	12V	6000K
<b>FITMENT</b>			
Toyota Avensis; Toyota Verso; Toyota Land Cruiser Fj150; Prado; Toyota Agya; Toyota Avanza; Toyota Aygo; Toyota Aqua; Toyota Camry; Toyota Camry Hybrid; Toyota Corolla; Toyota Corolla 4D; Toyota Corolla; Toyota Fortuner; Toyota Highlander; Toyota Land Cruiser Prado; Toyota Prius; Toyota Prius Alpha; Toyota Rav 4; Toyota Vios; Toyota Tundra; Lexus Rx270 / Rx350 / 450; Peugeot 107 / 108; Suzuki Kizashi; Citroen C1;			

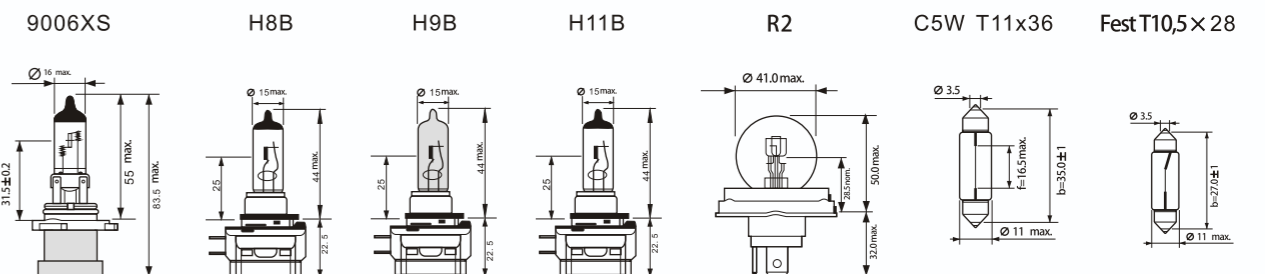
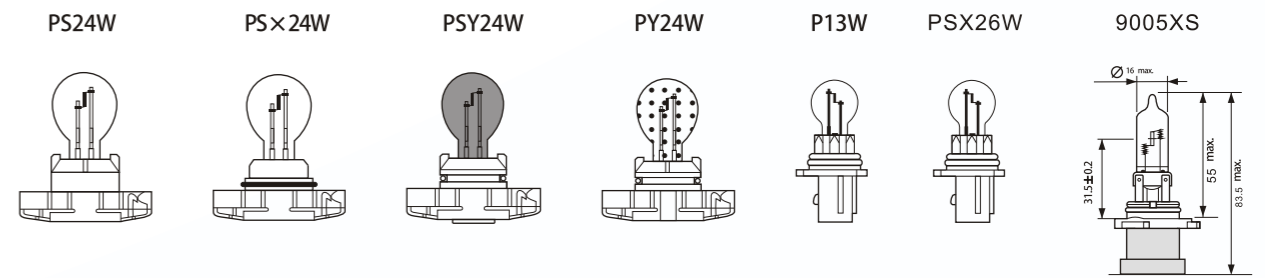
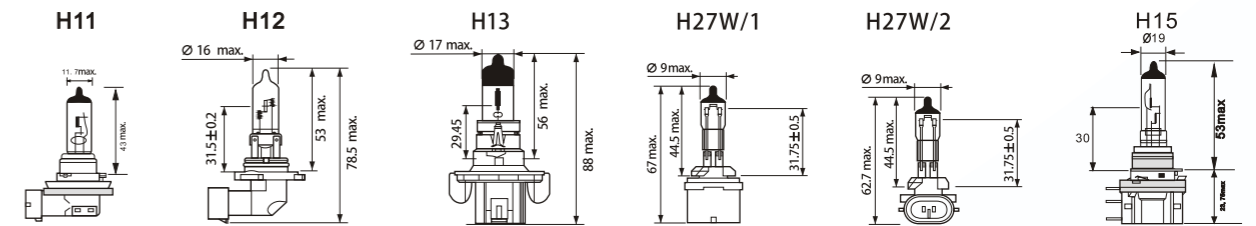
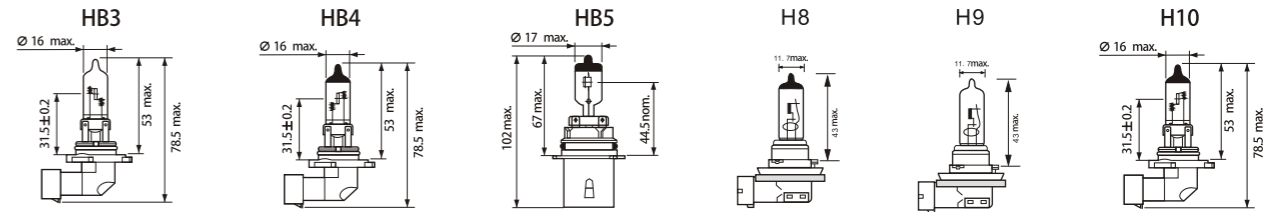
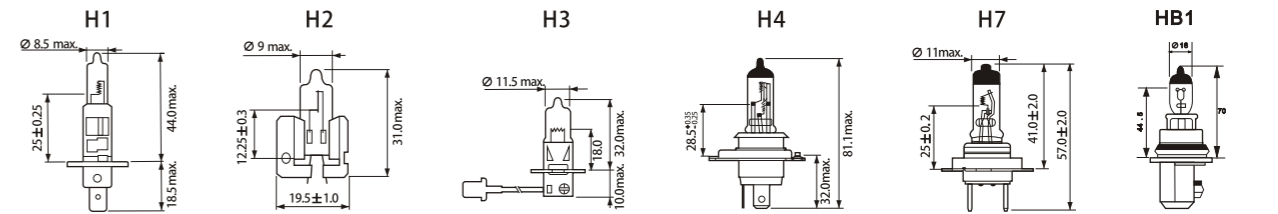

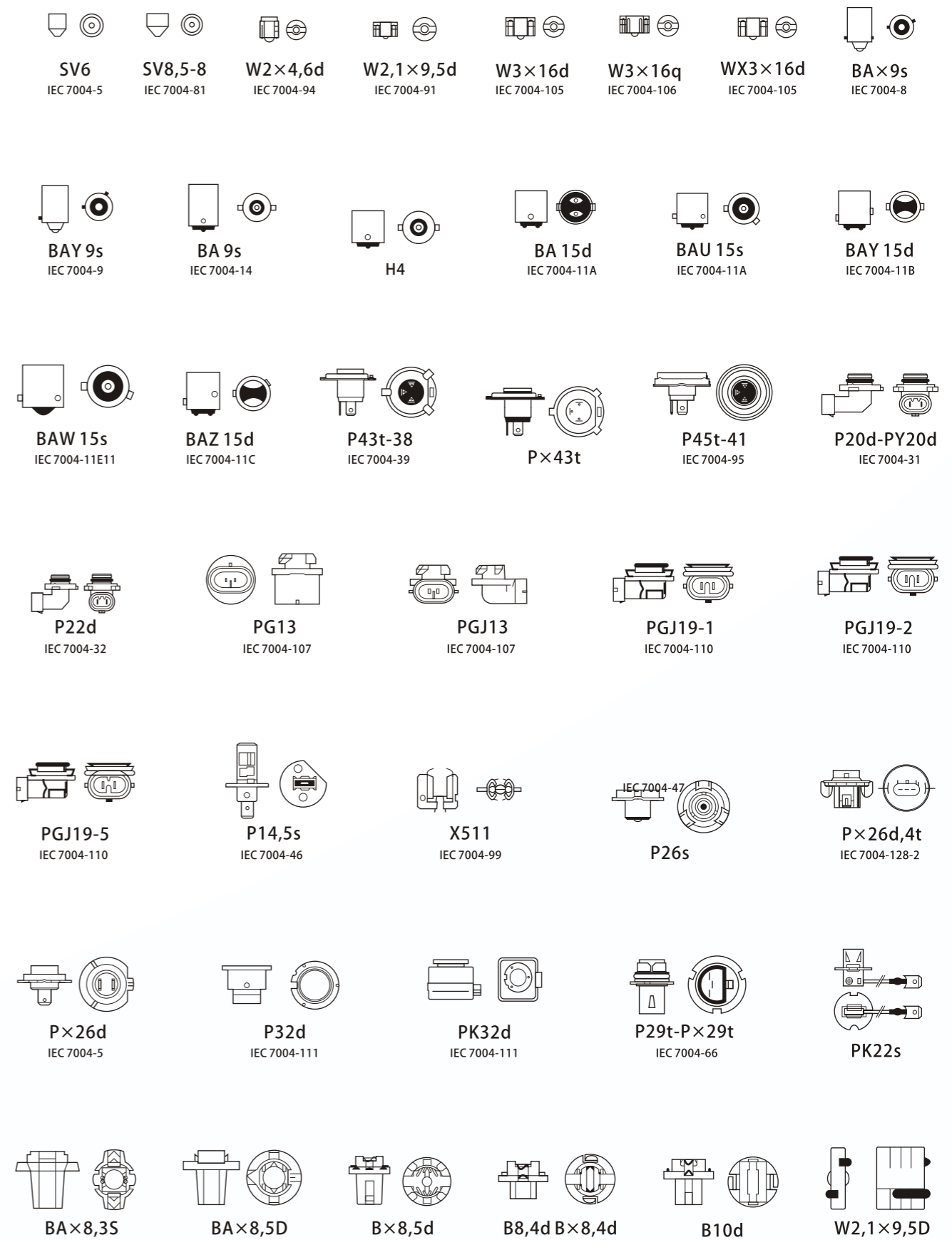

LAMP DRAWING

BASE DRAWING



**F21**



21W  
**2100lm**

**F21**

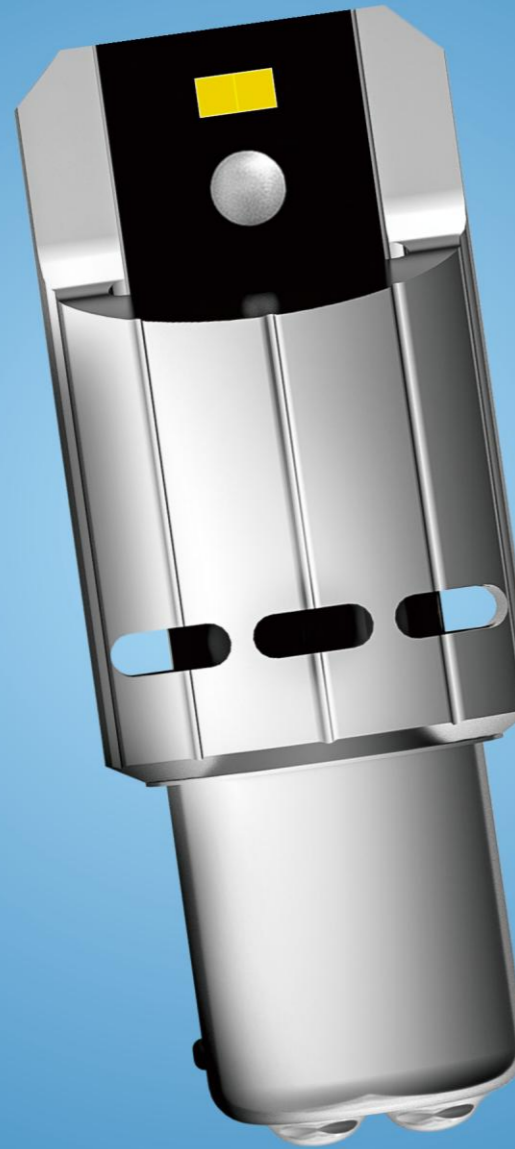

21W  
**2100lm**

**N9**



9W  
**900lm**

**S5C**

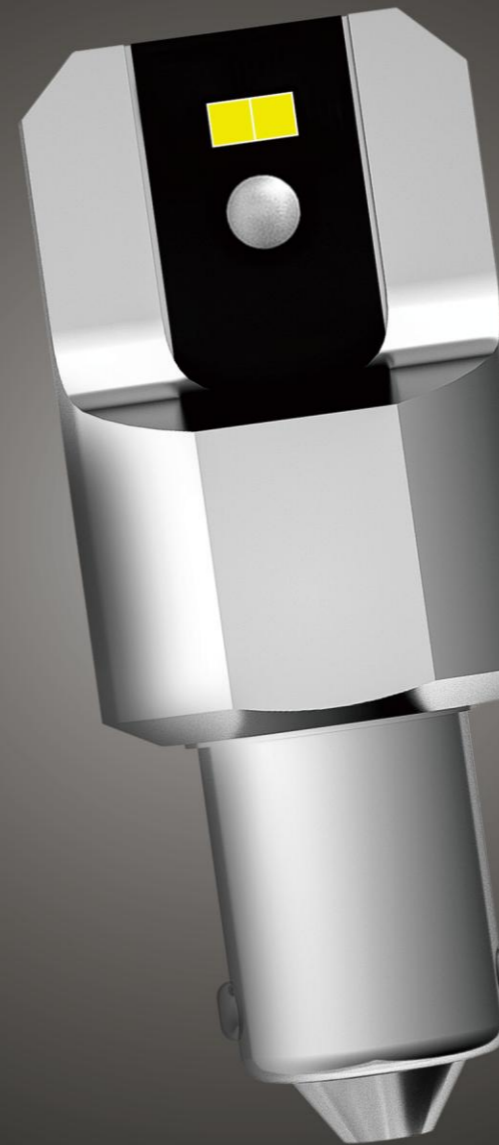

5W  
**500lm**

**N3**



3W  
**300lm**

**S2C**



2W  
**190lm**

# AUTOMOTIVE LED BULBS



Scan code for products details

## PREMIUM Series



### NS-S5C-T10-W-CAN

MODEL	BASE	COLOR	LED CHIPS	DC	FEATURE	
NS-S5C-T10-W-CAN	T10 W5W	White	4*3030U chips	12/24V	Constant current	FULL CANBUS,5W



### NS-S5C-T15-W-CAN

MODEL	BASE	COLOR	LED CHIPS	DC	FEATURE	
NS-S5C-T15-W-CAN	T15 W16W	White	4*3030U chips	12/24V	Constant current	FULL CANBUS,5W

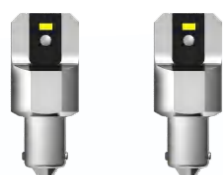

### NS-S5C-BA9S-W-CAN

MODEL	BASE	COLOR	LED CHIPS	DC	FEATURE	
NS-S5C-BA9S-W-CAN	BA9S	White	4*3030U chips	12/24V	Constant current	FULL CANBUS,5W



### NS-S2C-T10-W

MODEL	BASE	COLOR	LED CHIPS	DC	FEATURE	
NS-S2C-T10-W	T10 W5W	White	4*3020 chips	12/24V	Constant current	2W



### NS-S2C-T15-W

MODEL	BASE	COLOR	LED CHIPS	DC	FEATURE	
NS-S2C-T15-W	T15 W16W	White	4*3020 chips	12/24V	Constant current	2W



### NS-S2C-BA9S-W

MODEL	BASE	COLOR	LED CHIPS	DC	FEATURE	
NS-S2C-BA9S-W	BA9S	White	4*3020 chips	12/24V	Constant current	2W



### NS-F21-1156-W-CAN

MODEL	BASE	COLOR	LED CHIPS	DC	FEATURE	
NS-F21-1156-W-CAN	BA15S/BAU15S P21W/PY21W	White	2*1860SMD	12/24V	FAN built-in Constant current	FULL CANBUS,21W



### NS-F21-1157-W-CAN

MODEL	BASE	COLOR	LED CHIPS	DC	FEATURE	
NS-F21-1157-W-CAN	BAY15D P21/5W	White	2*1860SMD	12/24V	FAN built-in Constant current	FULL CANBUS,21W



### NS-F21-3156-W-CAN

MODEL	BASE	COLOR	LED CHIPS	DC	FEATURE	
NS-F21-3156-W-CAN	3156 P27W	White	2*1860SMD	12/24V	FAN built-in Constant current	FULL CANBUS,21W



### NS-F21-3157-W-CAN

MODEL	BASE	COLOR	LED CHIPS	DC	FEATURE	
NS-F21-3157-W-CAN	3157 P27/7W	White	2*1860SMD	12/24V	FAN built-in Constant current	FULL CANBUS,21W



**NS-F21-7440-W-CAN**

MODEL	BASE	COLOR	LED CHIPS	DC	FEATURE	
NS-F21-7440-W-CAN	7440 W21W/WY21W	White	2*1860SMD	12/24V	FAN built-in Constant current	FULL CANBUS,21W



**NS-F21-7443-W-CAN**

MODEL	BASE	COLOR	LED CHIPS	DC	FEATURE	
NS-F21-7443-W-CAN	7443 W21W/5W	White	2*1860SMD	12/24V	FAN built-in Constant current	FULL CANBUS,21W



**NS-N9-1156-W**

MODEL	BASE	COLOR	LED CHIPS	DC	FEATURE	
NS-N9-1156-W	BA15S/BAU15S P21W/PY21W	White	2*1860SMD	12/24V	Constant current	9W



**NS-N9-1157-W**

MODEL	BASE	COLOR	LED CHIPS	DC	FEATURE	
NS-N9-1157-W	BAY15D P21/5W	White	2*1860SMD	12/24V	Constant current	9W+1W



**NS-N9-3156-W**

MODEL	BASE	COLOR	LED CHIPS	DC	FEATURE	
NS-N9-3156-W	3156 P27W	White	2*1860SMD	12/24V	Constant current	9W



**NS-N9-3157-W**

MODEL	BASE	COLOR	LED CHIPS	DC	FEATURE	
NS-N9-3157-W	3157 P27/7W	White	2*1860SMD	12/24V	Constant current	9W+1W



**NS-N9-7440-W**

MODEL	BASE	COLOR	LED CHIPS	DC	FEATURE	
NS-N9-7440-W	7440 W21W/WY21W	White	2*1860SMD	12/24V	Constant current	9W



**NS-N9-7443-W**

MODEL	BASE	COLOR	LED CHIPS	DC	FEATURE	
NS-N9-7443-W	7443 W21/5W	White	2*1860SMD	12/24V	Constant current	9W+1W



**NS-N3-1156-W**

MODEL	BASE	COLOR	LED CHIPS	DC	FEATURE	
NS-N3-1156-W	BA15S/BAU15S P21W/PY21W	White	4*3030SMD	12/24V	Constant current	3W



**NS-N3-1157-W**

MODEL	BASE	COLOR	LED CHIPS	DC	FEATURE	
NS-N3-1157-W	BAY15D P21/5W	White	4*3030SMD	12/24V	Constant current	3W+0.43W



**NS-N3-3156-W**

MODEL	BASE	COLOR	LED CHIPS	DC	FEATURE	
NS-N3-3156-W	3156 P27W	White	4*3030SMD	12/24V	Constant current	3W



**NS-N3-3157-W**

MODEL	BASE	COLOR	LED CHIPS	DC	FEATURE	
NS-N3-3157-W	3157 P27/7W	White	4*3030SMD	12/24V	Constant current	3W+0.43W



**NS-N3-7440-W**

MODEL	BASE	COLOR	LED CHIPS	DC	FEATURE	
NS-N3-7440-W	7440 W21W/WY21W	White	4*3030SMD	12/24V	Constant current	3W



**NS-N3-7443-W**

MODEL	BASE	COLOR	LED CHIPS	DC	FEATURE	
NS-N3-7443-W	7443 W21/5W	White	4*3030SMD	12/24V	Constant current	3W+0.43W

# Ultra Canbus Series



Series type	Metalic	Non-polarity	12/24V	CANBUS	12V
Ultra-U	✓	✓	✓	✓	✓
Super-S	—	✓	✓	✓	✓
Light-L	—	—	—	✓	✓
Classic	—	—	—	—	✓



## NS-T10-6SMD-3030-U

MODEL	BASE	COLOR	LED CHIPS	DC	FEATURE	
NS-T10-6SMD-3030-U	T10 W5W	White	6*3030chips	12V/24V	Constant current	CANBUS

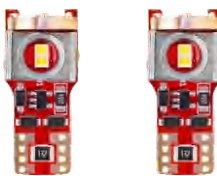

## NS-T10-6SMD-2016-U

MODEL	BASE	COLOR	LED CHIPS	DC	FEATURE	
NS-T10-6SMD-2016-U	T10 W5W	White	6*2016chips	12/24V	Constant current	CANBUS

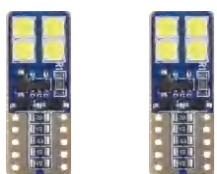

## NS-T10-8SMD-2835-U

MODEL	BASE	COLOR	LED CHIPS	DC	FEATURE	
NS-T10-8SMD-2835-U	T10 W5W	White	8*2835chips	12/24V	Constant current	CANBUS

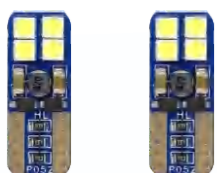

## NS-T10-8SMD-3030-U

MODEL	BASE	COLOR	LED CHIPS	DC	FEATURE	
NS-T10-8SMD-3030-U	T10 W5W	White	8*3030 chips	12/24V	Constant current	CANBUS



## NS-T10-12SMD-2835-U

MODEL	BASE	COLOR	LED CHIPS	DC	FEATURE	
NS-T10-12SMD-2835-U	T10 W5W	White	12*2835chips	12/24V	Constant current	CANBUS



## NS-T10-12SMD-3030-U

MODEL	BASE	COLOR	LED CHIPS	DC	FEATURE	
NS-T10-12SMD-3030-U	T10 W5W	White	12*3030 chips	12/24V	Constant current	CANBUS



## NS-T10-18SMD-2016-U

MODEL	BASE	COLOR	LED CHIPS	DC	FEATURE	
NS-T10-18SMD-2016-U	T10 W5W	White	18*2016chips	12/24V	Constant current	CANBUS



## NS-T10-21SMD-2016-U

MODEL	BASE	COLOR	LED CHIPS	DC	FEATURE	
NS-T10-21SMD-2016-U	T10 W5W	White	21*2016 chips	12V/24V	Constant current	CANBUS



## NS-T20/S25-15SMD-3030-U

MODEL	BASE	COLOR	LED CHIPS	DC	FEATURE	
NS-T20/S25-15SMD-3030-U	1156/1157/7440/7443/3156/3157	White	15*3030SMD	12/24V	Constant current	CANBUS



## NS-T20/S25-24SMD-3020-U

MODEL	BASE	COLOR	LED CHIPS	DC	FEATURE	
NS-T20/S25-24SMD-3020-U	1156/1157/7440/7443/3156/3157	White	24*3020SMD	12/24V	Constant current	CANBUS



## NS-T20/S25-35SMD-3030-U

MODEL	BASE	COLOR	LED CHIPS	DC	FEATURE	
NS-T20/S25-35SMD-3030-U	1156/1157/7440/7443/3156/3157	White	35*3030SMD	12/24V	Constant current	CANBUS

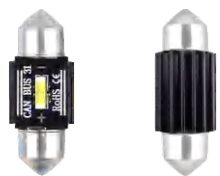

**NS-SJ-1SMD-1860-31MM-U**

MODEL	BASE	COLOR	LED CHIPS	DC	FEATURE	
NS-SJ-1SMD-1860-31MM-U	FESTOON C5W	White	1860	12/24V	Constant Current Canbus	31MM



**NS-SJ-1SMD-1860-36MM-U**

MODEL	BASE	COLOR	LED CHIPS	DC	FEATURE	
NS-SJ-1SMD-1860-36MM-U	FESTOON C5W	White	1860	12/24V	Constant Current Canbus	36MM



**NS-SJ-1SMD-1860-39MM-U**

MODEL	BASE	COLOR	LED CHIPS	DC	FEATURE	
NS-SJ-1SMD-1860-39MM-U	FESTOON C5W	White	1860	12/24V	Constant Current Canbus	39MM



**NS-SJ-1SMD-1860-41MM-U**

MODEL	BASE	COLOR	LED CHIPS	DC	FEATURE	
NS-SJ-1SMD-1860-41MM-U	FESTOON C5W	White	1860	12/24V	Constant Current Canbus	41MM

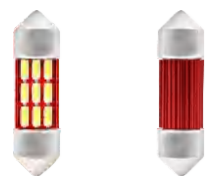

**NS-SJ-9SMD-4014-31MM-U**

MODEL	BASE	COLOR	LED CHIPS	DC	FEATURE	
NS-SJ-9SMD-4014-31MM-U	FESTOON C5W	White	12*4014 chips	12/24V	Constant Current Canbus	31MM

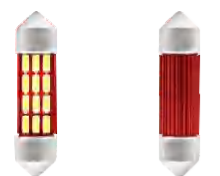

**NS-SJ-12SMD-4014-36MM-U**

MODEL	BASE	COLOR	LED CHIPS	DC	FEATURE	
NS-SJ-12SMD-4014-36MM-U	FESTOON C5W	White	12*4014 chips	12/24V	Constant Current Canbus	36MM

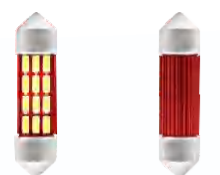

**NS-SJ-12SMD-4014-39MM-U**

MODEL	BASE	COLOR	LED CHIPS	DC	FEATURE	
NS-SJ-12SMD-4014-39MM-U	FESTOON C5W	White	12*4014 chips	12/24V	Constant Current Canbus	39MM

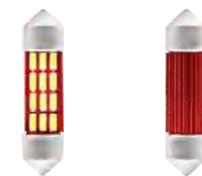

**NS-SJ-12SMD-4014-41MM-U**

MODEL	BASE	COLOR	LED CHIPS	DC	FEATURE	
NS-SJ-12SMD-4014-41MM-U	FESTOON C5W	White	12*4014 chips	12/24V	Constant Current Canbus	41MM

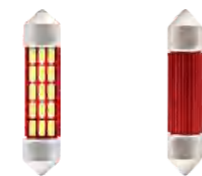

**NS-SJ-15SMD-4014-36MM-U**

MODEL	BASE	COLOR	LED CHIPS	DC	FEATURE	
NS-SJ-15SMD-4014-36MM-U	FESTOON C5W	White	16*4014 chips	12/24V	Constant Current Canbus	36MM

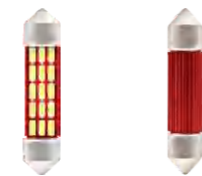

**NS-SJ-15SMD-4014-39MM-U**

MODEL	BASE	COLOR	LED CHIPS	DC	FEATURE	
NS-SJ-15SMD-4014-39MM-U	FESTOON C5W	White	16*4014 chips	12/24V	Constant Current Canbus	39MM

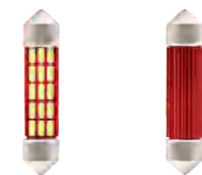

**NS-SJ-15SMD-4014-41MM-U**

MODEL	BASE	COLOR	LED CHIPS	DC	FEATURE	
NS-SJ-15SMD-4014-41MM-U	FESTOON C5W	White	20*4014 chips	12/24V	Constant Current Canbus	41MM



**NS-SJ-10SMD-4014-31MM-U**

MODEL	BASE	COLOR	LED CHIPS	DC	FEATURE	
NS-SJ-10SMD-4014-31MM-U	FESTOON C5W	White	10*4014 chips	12/24V	Constant Current Canbus	31MM



**NS-SJ-10SMD-4014-36MM-U**

MODEL	BASE	COLOR	LED CHIPS	DC	FEATURE	
NS-SJ-10SMD-4014-36MM-U	FESTOON C5W	White	10*4014 chips	12/24V	Constant Current Canbus	36MM



**NS-SJ-10SMD-4014-39MM-U**

MODEL	BASE	COLOR	LED CHIPS	DC	FEATURE	
NS-SJ-10SMD-4014-39MM-U	FESTOON C5W	White	10*4014 chips	12/24V	Constant Current Canbus	39MM



**NS-SJ-10SMD-4014-41MM-U**

MODEL	BASE	COLOR	LED CHIPS	DC	FEATURE	
NS-SJ-10SMD-4014-41MM-U	FESTOON C5W	White	10*4014 chips	12/24V	Constant Current Canbus	41MM



**NS-SJ-18SMD-3014-31MM-U**

MODEL	BASE	COLOR	LED CHIPS	DC	FEATURE	
NS-SJ-18SMD-3014-31MM-U	FESTOON C5W	White	18*3014chips	12/24V	Constant Current Canbus	31MM



**NS-SJ-18SMD-3014-39MM-U**

MODEL	BASE	COLOR	LED CHIPS	DC	FEATURE	
NS-SJ-18SMD-3014-39MM-U	FESTOON C5W	White	18*3014chips	12/24V	Constant Current Canbus	39MM



**NS-SJ-27SMD-3014-36MM-U**

MODEL	BASE	COLOR	LED CHIPS	DC	FEATURE	
NS-SJ-27SMD-3014-36MM-U	FESTOON C5W	White	27*3014chips	12/24V	Constant Current Canbus	36MM

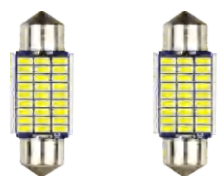

**NS-SJ-27SMD-3014-39MM-U**

MODEL	BASE	COLOR	LED CHIPS	DC	FEATURE	
NS-SJ-27SMD-3014-39MM-U	FESTOON C5W	White	27*3014chips	12/24V	Constant Current Canbus	39MM



**NS-SJ-30SMD-3014-41MM-U**

MODEL	BASE	COLOR	LED CHIPS	DC	FEATURE	
NS-SJ-30SMD-3014-41MM-U	FESTOON C5W	White	30*3014chips	12/24V	Constant Current Canbus	41MM

# Super Canbus Series

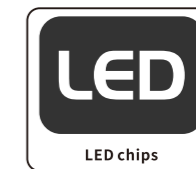
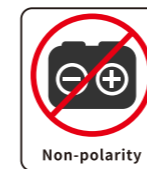

Series type	Metalic	Non-polarity	12/24V	CANBUS	12V
Ultra-U	✓	✓	✓	✓	✓
Super-S	—	✓	✓	✓	✓
Light-L	—	—	—	✓	✓
Classic	—	—	—	—	✓



**NS-T10-6SMD-3030-S**

MODEL	BASE	COLOR	LED CHIPS	DC	FEATURE	
NS-T10-6SMD-3030-S	T10 W5W	White	6*3030chips	12V/24V	Constant current	CANBUS

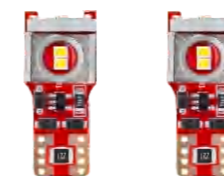

**NS-T10-6SMD-2016-S**

MODEL	BASE	COLOR	LED CHIPS	DC	FEATURE	
NS-T10-6SMD-2016-S	T10 W5W	White	6*2016chips	12/24V	Constant current	CANBUS



**NS-T10-8SMD-2835-S**

MODEL	BASE	COLOR	LED CHIPS	DC	FEATURE	
NS-T10-8SMD-2835-S	T10 W5W	White	8*2835chips	12/24V	Constant current	CANBUS



**NS-T10-8SMD-3030-S**

MODEL	BASE	COLOR	LED CHIPS	DC	FEATURE	
NS-T10-8SMD-3030-S	T10 W5W	White	8*3030 chips	12/24V	Constant current	CANBUS



**NS-T10-12SMD-2835-S**

MODEL	BASE	COLOR	LED CHIPS	DC	FEATURE	
NS-T10-12SMD-2835-S	T10 W5W	White	12*2835chips	12/24V	Constant current	CANBUS



**NS-T10-12SMD-3030-S**

MODEL	BASE	COLOR	LED CHIPS	DC	FEATURE	
NS-T10-12SMD-3030-S	T10 W5W	White	12*3030 chips	12/24V	Constant current	CANBUS



**NS-T10-18SMD-2016-S**

MODEL	BASE	COLOR	LED CHIPS	DC	FEATURE	
NS-T10-18SMD-2016-S	T10 W5W	White	18*2016chips	12/24V	Constant current	CANBUS



**NS-T10-21SMD-2016-S**

MODEL	BASE	COLOR	LED CHIPS	DC	FEATURE	
NS-T10-21SMD-2016-S	T10 W5W	White	21*2016 chips	12V/24V	Constant current	CANBUS

# Light Canbus Series

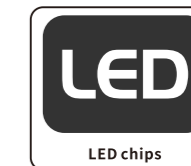

Series type	Metalic	Non-polarity	12/24V	CANBUS	12V
Ultra-U	✓	✓	✓	✓	✓
Super-S	—	✓	✓	✓	✓
Light-L	—	—	—	✓	✓
Classic	—	—	—	—	✓



**NS-T10-6SMD-5730-L**

MODEL	BASE	COLOR	LED CHIPS	DC	FEATURE
NS-T10-6SMD-5730-L	T10 W5W	White	6*5730chips	12V	CANBUS



**NS-T10-6SMD-3030-L**

MODEL	BASE	COLOR	LED CHIPS	DC	FEATURE
NS-T10-6SMD-3030-L	T10 W5W	White	6*3030chips	12V	CANBUS



**NS-T10-18SMD-3014-L**

MODEL	BASE	COLOR	LED CHIPS	DC	FEATURE
NS-T10-18SMD-3014-L	T10 W5W	White	18*3014 chips	12V	CANBUS

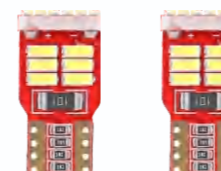

**NS-T10-18SMD-4014-L**

MODEL	BASE	COLOR	LED CHIPS	DC	FEATURE
NS-T10-18SMD-4014-L	T10 W5W	White	18*4014chips	12V	CANBUS

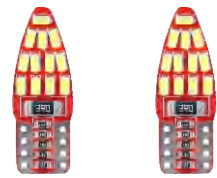

**NS-T10-24SMD-3014-L**

MODEL	BASE	COLOR	LED CHIPS	DC	FEATURE
NS-T10-24SMD-3014-L	T10 W5W	White	24*3014 chips	12V	CANBUS

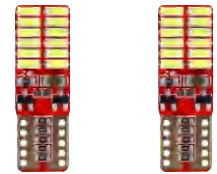

**NS-T10-24SMD-4014-L**

MODEL	BASE	COLOR	LED CHIPS	DC	FEATURE
NS-T10-24SMD-4014-L	T10 W5W	White	24*4014 chips	12V	CANBUS

LED BULB

LED BULB

# Classical Series

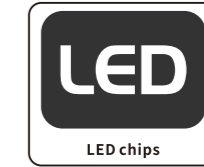

Series type	Metalic	Non-polarity	12/24V	CANBUS	12V
Ultra-U	✓	✓	✓	✓	✓
Super-S	—	✓	✓	✓	✓
Light-L	—	—	—	✓	✓
Classic	—	—	—	—	✓



**NS-T10-5SMD-5050-C**

MODEL	BASE	COLOR	LED CHIPS	DC	FEATURE
NS-T10-5SMD-5050-C	T10 W5W	White	5*5050chips	12V	economic



**NS-SJ-8SMD-5050-31MM-C**

MODEL	BASE	COLOR	LED CHIPS	DC	FEATURE	
NS-SJ-8SMD-5050-31mm-C	FESTOON C5W	White	8*5050chips	12V	economic	31MM



**NS-SJ-8SMD-5050-36MM-C**

MODEL	BASE	COLOR	LED CHIPS	DC	FEATURE	
NS-SJ-8SMD-5050-36mm-C	FESTOON C5W	White	8*5050chips	12V	economic	36MM



**NS-SJ-8SMD-5050-39MM-C**

MODEL	BASE	COLOR	LED CHIPS	DC	FEATURE	
NS-SJ-8SMD-5050-39mm-C	FESTOON C5W	White	8*5050chips	12V	economic	39MM





**NS-SJ-8SMD-5050-41MM-C**

MODEL	BASE	COLOR	LED CHIPS	DC	FEATURE	
NS-SJ-8SMD-5050-41mm-C	FESTOON C5W	White	8*5050chips	12V	economic	41MM



**NS-T10-9SMD-5050-C**

MODEL	BASE	COLOR	LED CHIPS	DC	FEATURE	
NS-T10-9SMD-5050-C	T10 W5W	White	9*5050chips	12V	economic	



**NS-T10-13SMD-5050-C**

MODEL	BASE	COLOR	LED CHIPS	DC	FEATURE	
NS-T10-13SMD-5050-C	T10 W5W	White	13*5050chips	12V	economic	



**NS-S25/T20-13SMD-5050-C**

MODEL	BASE	COLOR	LED CHIPS	DC	FEATURE	
NS-S25/T20-13SMD-5050-C	1156/1157/7440/7443/3156/3157	White	13*5050chips	12/24V	economic	

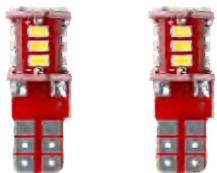

**NS-T10-21SMD-3014-C**

MODEL	BASE	COLOR	LED CHIPS	DC	FEATURE	
NS-T10-21SMD-3014-C	T10 W5W	White	21*3014 chips	12V	economic	

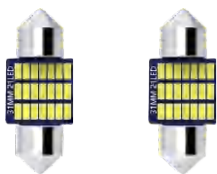

**NS-SJ-21SMD-3014-31MM-C**

MODEL	BASE	COLOR	LED CHIPS	DC	FEATURE	
NS-SJ-21SMD-3014-31mm-C	FESTOON C5W	White	21*3014 chips	12/24V	economic	31MM

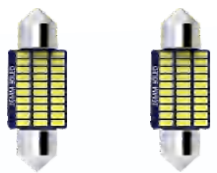

**NS-SJ-30SMD-3014-36MM-C**

MODEL	BASE	COLOR	LED CHIPS	DC	FEATURE	
NS-SJ-30SMD-3014-36mm-C	FESTOON C5W	White	30*3014 chips	12/24V	economic	36MM



**NS-SJ-30SMD-3014-39MM-C**

MODEL	BASE	COLOR	LED CHIPS	DC	FEATURE	
NS-SJ-30SMD-3014-39mm-C	FESTOON C5W	White	30*3014 chips	12/24V	economic	39MM



**NS-SJ-30SMD-3014-41MM-C**

MODEL	BASE	COLOR	LED CHIPS	DC	FEATURE	
NS-SJ-30SMD-3014-41mm-C	FESTOON C5W	White	30*3014 chips	12/24V	economic	41MM



**NS-SJ-42SMD-3014-44MM-C**

MODEL	BASE	COLOR	LED CHIPS	DC	FEATURE	
NS-SJ-42SMD-3014-44mm-C	FESTOON C5W	White	42*3014 chips	12/24V	economic	44MM

# ALL-TERRAIN HIGH PERFORMANCE CAMPING LIGHT WITH TELESCOPIC ROD



- Foldable design
- Multipurpose Use
- Stepless Colors & 3 Gear Brightness
- Built-in 10000mAh rechargeable battery, built-in Type-C charging port(input 5V/2A, output 5V/3A)
- Durable & Waterproof, IPX7

## Parameter

Material of Housing	PC plastic +Nylon
Product Dimensions	Φ 66mm, height adjustable from 246mm to 970mm
Battery	Lithium rechargeable battery, 4.5W
LED Color Temperature	1800K for amber color LED and 6500K for white color LED
Time of Endurance	9~45 hours
Waterproof	IPX7

## Stepless Color Temperature Adjustment

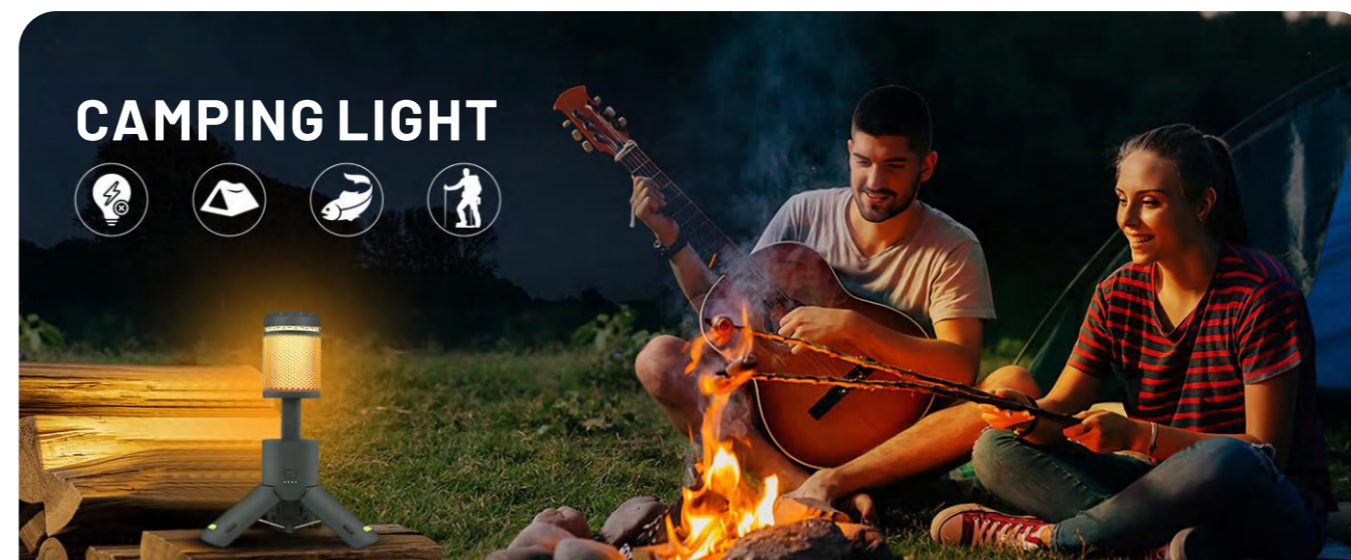
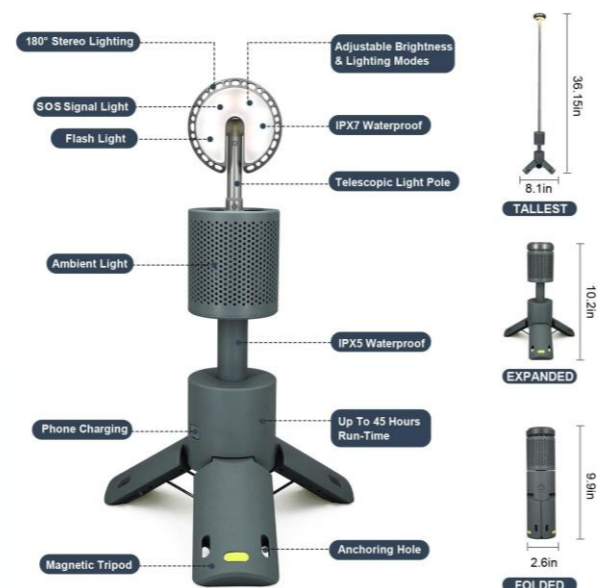

# LIGHT FOR EVERYWHERE

It can be used for everywhere



- Automatic Light Sensor
- Magnetic + sticker installation, NO damage
- Wiring-free
- Type-C charging port
- Product materials: ABS +AL6061

## Parameter

Length	23cm	30cm	40cm
Product size	23*4.1*0.9cm	30*4.1*0.9cm	40*4.1*0.9cm
Power	1.2W	1.5W	1.8W
Battery capacity	1100mAh	1500mAh	1500mAh



- AUTO** First touch: Smart Sensor Mode
- ON** Second touch: always - on mode
- OFF** Third touch: Turn off

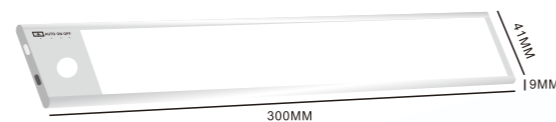

**ON** Long press the switch for stepless dimming

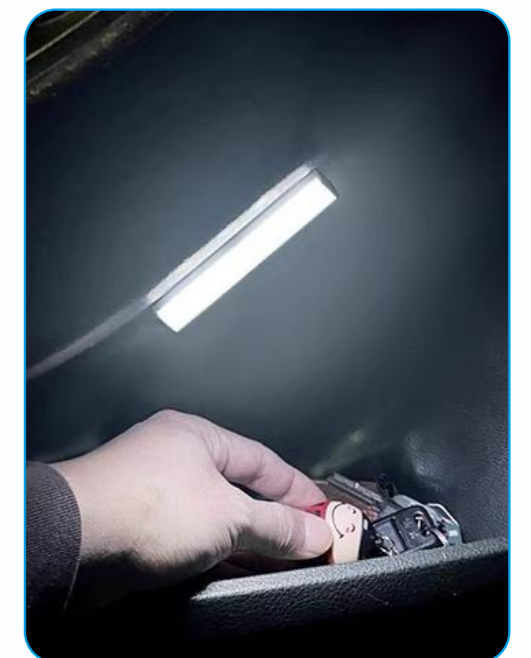
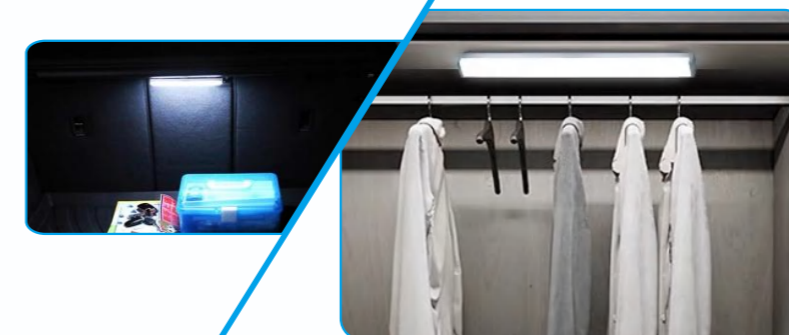
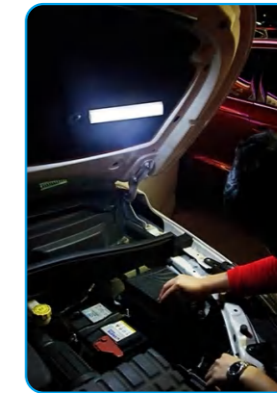
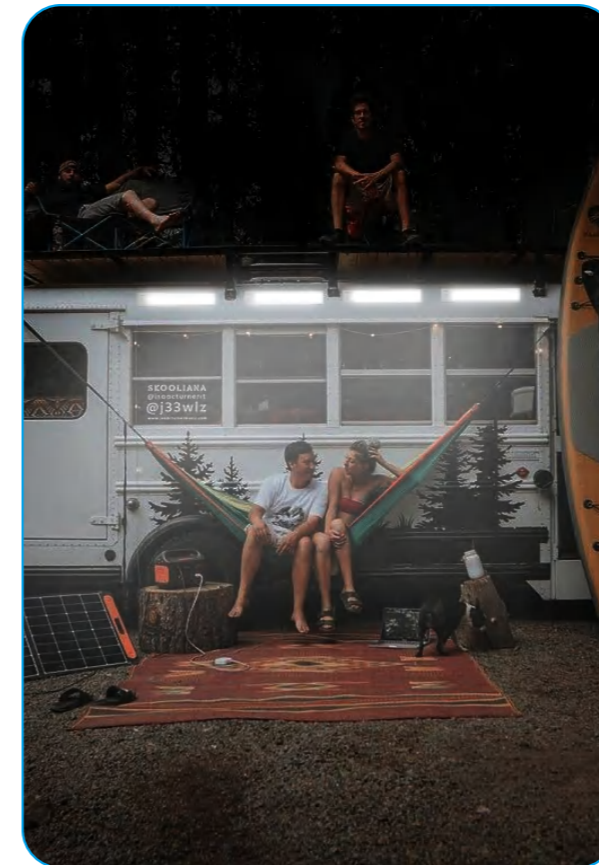
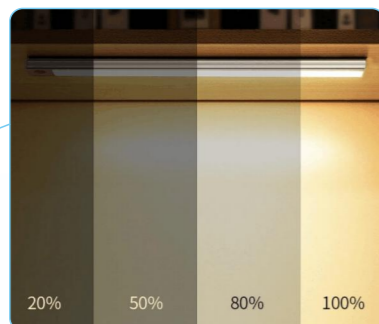

WORK LIGHT & LIGHT BAR

# WORK LIGHT & LIGHT BAR



Scan code for products details

CE RoHS E24 -R112, R7, R148, R149

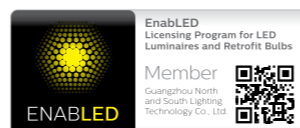
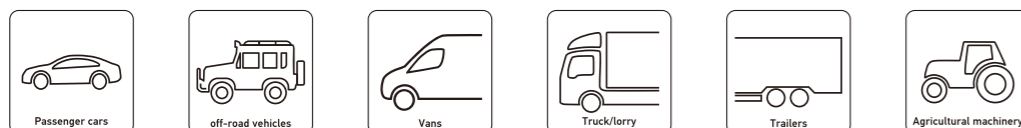

## NS-RD-35W

POWER	VOLTAGE	CHIPS	MATERIAL
35W	9-36V	7*5W CREE XT-E	AL 6063
WATERPROOF	EMI/RFI	LUMEN	BEAM PATTERNS
IP68	CISPR25	4340lm	Spot / flood

## NS-RD-50W

POWER	VOLTAGE	CHIPS	MATERIAL
50W	9-36V	5*10W CREE XM-L	AL 6063
WATERPROOF	EMI/RFI	LUMEN	BEAM PATTERNS
IP68	CISPR25	7300lm	Spot / flood

## NS-RD-O60

POWER	VOLTAGE	CHIPS	MATERIAL
60W	9-36V	6*10W CREE XM-L	AL 6063
WATERPROOF	EMI/RFI	LUMEN	BEAM PATTERNS
IP68	CISPR25	8760lm	Spot (perfect beam)

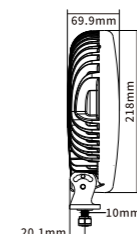
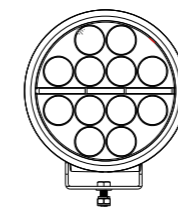
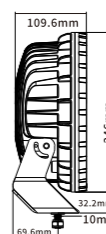
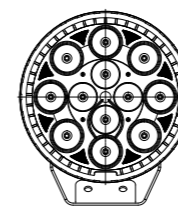
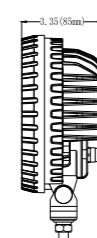
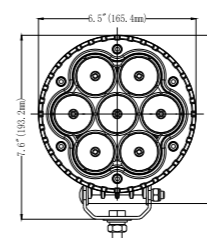
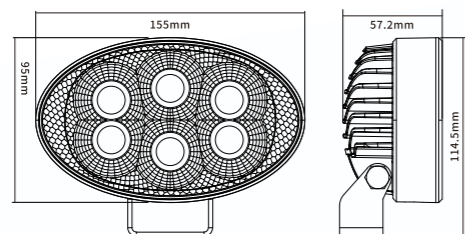
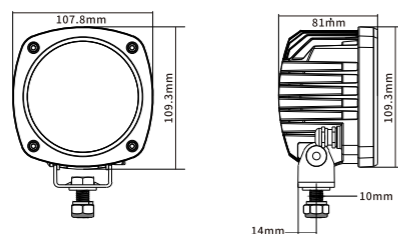
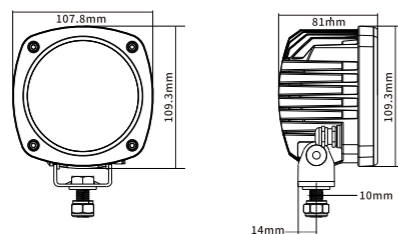

## NS-RD-70W

POWER	VOLTAGE	CHIPS	MATERIAL
70W	9-36V	7*10W CREE XM-L	AL 6063
WATERPROOF	EMI/RFI	LUMEN	BEAM PATTERNS
IP68	CISPR25	10220lm	Spot / flood / combo

## NS-RD-120W

POWER	VOLTAGE	CHIPS	MATERIAL
120W	9-36V	12*10W CREE XM-L	AL 6063
WATERPROOF	EMI/RFI	LUMEN	BEAM PATTERNS
IP68	CISPR25	17520lm	Spot / flood

## NS-RD-180W

POWER	VOLTAGE	CHIPS	MATERIAL
180W	9-36V	18*10W CREE XM-L	AL 6063
WATERPROOF	EMI/RFI	LUMEN	BEAM PATTERNS
IP68	CISPR25	26280lm	Spot

MAX 180W, 740lm 1lux, dual color (white&red) parking light.

## NS-WL-1R20

POWER	VOLTAGE	CHIPS	LUMEN	SIZE/GW			
100W	DC9-32V	CREE XT-E 5W	14000lm	22"*2.6"*2.5"/3KG			
1R SERIES (OPTIONS)	SIZE	4"	6"	10"	30"	40"	50"
	POWER	20W	30W	50W	150W	200W	250W

## NS-WL-2R20

POWER	VOLTAGE	CHIPS	LUMEN	SIZE/GW			
120W	DC9-32V	CREE XP-E 3W	16800lm	22"*23.5"*3.2"/4KG			
2R SERIES (OPTIONS)	SIZE	4"	6"	10"	30"	40"	50"
	POWER	24W	36W	60W	180W	240W	300W

## NS-LB-1R20 E1 EMARK

POWER	VOLTAGE	CHIPS	LUMEN	SIZE/GW	
80W	DC9-32V	CREE XM-L 10W	13000lm	18.2"*3.2"*3.1"/3.9KG	
LB SERIES (OPTIONS)	SIZE	10"	26"	35"	43"
	POWER	40W	120W	160W	200W

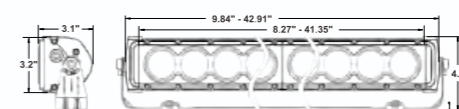
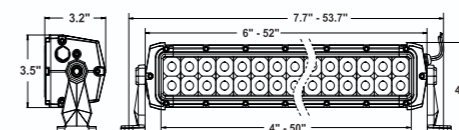
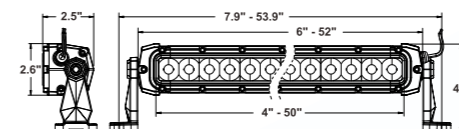



Scan code for products details

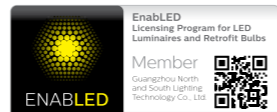

**LED BMW Angel-Eyes**



**PERFECT BRIGHTNESS RINGS**  
Both rings have the same brightness

**SUPER BRIGHTNESS**  
6500K white light, brighter than original

**ERROR FREE**  
Built-in resistor, no interference



- 6063 ALUMINUM EXTRUSION**
- CREE ORIGINAL CHIPS, XT-E, XM-L**
- CANBUS ERROR FREE**
- NO NOISE**
- SMALLER BODY FOR 99% RELATED BMW CARS**
- PATENT PRODUCTS**

BEFORE

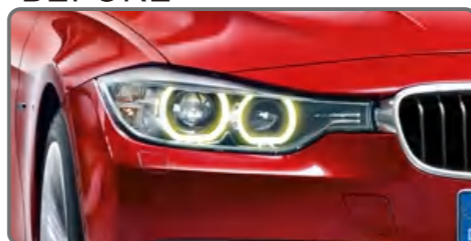

AFTER

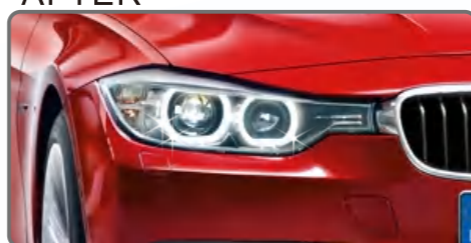

NSSC use top-rated CREE ORIGINAL CHIPS to ensure the highest output and maximum lifespan.

Upgrade Version to create brighter outer ring



**NS-AE-E39-10W**

POWER	MATERIAL	FEATURE	CANBUS
10W XML Chip	ONE-BODY AL6063	NO OVER-HEAT	ERROR FREE
<b>AVAILABLE CAR</b>	E39 (01-03) E53(04-06) / E65(02-08) E66(02-08) / E60 (04-06) E6(04-06) E63 (04-07.6) E64 (04-07.6) / E87 (04-06) X3 (08)		



**NS-AE-E90-20W**

POWER	MATERIAL	FEATURE	CANBUS
2*CREE XML chips	ONE-BODY AL6063	NO OVER-HEAT	ERROR FREE
<b>AVAILABLE CAR</b>	E90/91 sedan/wagon with Xenon (2005-2008 Pre-LCI)		



**NS-AE-E90L-20W**

POWER	MATERIAL	FEATURE	CANBUS
2*CREE XML chips	ONE-BODY AL6063	NO OVER-HEAT	ERROR FREE
<b>AVAILABLE CAR</b>	E90/91 sedan/wagon with HALOGEN (2005-2008 Pre-LCI)		



**NS-AE-H8-20W**

POWER	MATERIAL	FEATURE	CANBUS
2*CREE XML chips	ONE-BODY AL6063	NO OVER-HEAT	ERROR FREE
<b>AVAILABLE CAR</b>	E60 (2008-Current) / E82   (2007-Current) / E90, E92, E93   (2006-Current) E84   (2010-Current) / E70 / E71   (2008-Current) / E89   (2009-Current)		



**NS-H8-40W-G5**

POWER	MATERIAL	FEATURE	CANBUS
4*CREE XML chips	ONE-BODY AL6063	NO OVER-HEAT	ERROR FREE
<b>AVAILABLE CAR</b>	E60 (2008-Current) / E82   (2007-Current) / E90, E92, E93   (2006-Current) E84   (2010-Current) / E70 / E71   (2008-Current) / E89   (2009-Current)		

# DRL DAYTIME RUNNING LIGHT

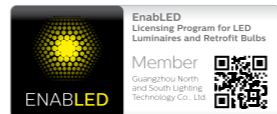

Scan code for products details



E24 148R00/\*\*\*\*00

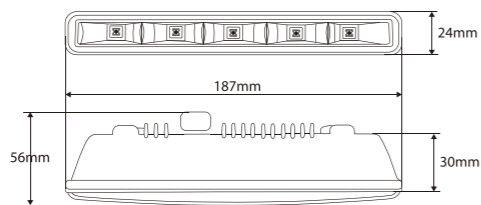

## DRL 501HP

VOLTAGE	LUMEN	LED CHIPS
12/24V	1000lm	10*High Power SMD LED



E24 148R00/\*\*\*\*00

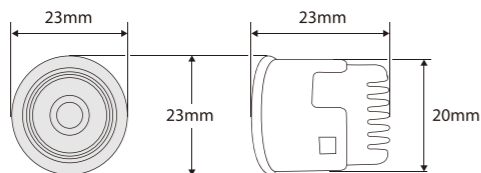

## DRL 502HP Mini

VOLTAGE	LUMEN	LED CHIPS
12/24V	900lm	10*SMD LED



E24 148R00/\*\*\*\*00

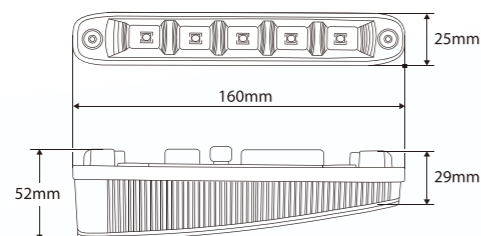

## DRL 506HP

VOLTAGE	LUMEN	LED CHIPS
12/24V	1000lm	10*High Power SMD LED

## DRL

E24 148R00/\*\*\*\*00

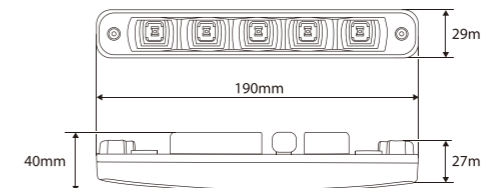

## DRL 507HP

VOLTAGE	LUMEN	LED CHIPS
12/24V	1000lm	10*High Power SMD LED

E24 148R00/\*\*\*\*00

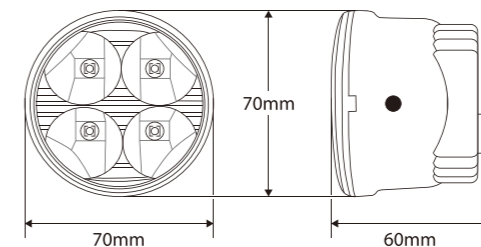

## DRL 510HP

VOLTAGE	LUMEN	LED CHIPS
12/24V	800lm	8*High Power SMD LED

E24 148R00/\*\*\*\*00

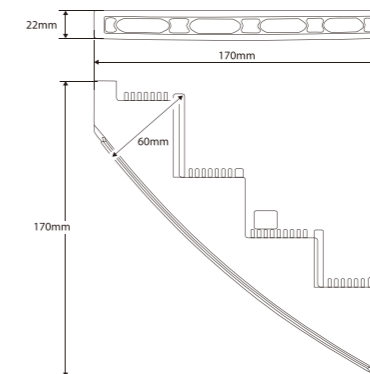

## DRL 523HP Mini

VOLTAGE	LUMEN	LED CHIPS
12/24V	1200lm	8*High Power SMD LED(1.5)

E24 148R00/\*\*\*\*00

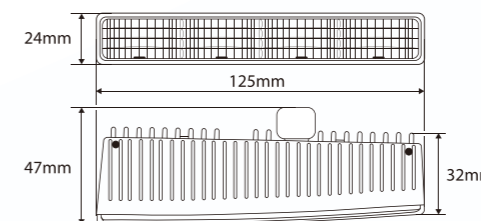

## DRL 540

VOLTAGE	LUMEN	LED CHIPS
12V	800lm	8*SMD LED

E24 148R00/\*\*\*\*00

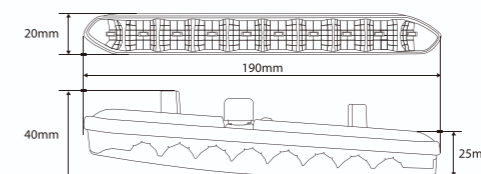

## DRL 810

VOLTAGE	LUMEN	LED CHIPS
12/24V	800lm	20*SMD LED

DAYTIME RUNNING LIGHT

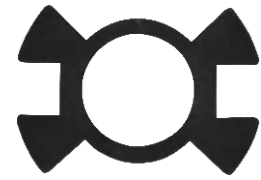

**S/N: NS01**

**MODEL: H1**  
**CAR MODELS:**  
 Honda (High Beam): Odyssey ...  
 Geely (High Beam): Vision, Global Hawk...  
 Southeast (High Beam): V3, V5, Lingshi  
 FreeCa, DX7...  
 Dongfeng (High Beam): ...



**S/N: NS02**

**MODEL: H7**  
**CAR MODELS:**  
 KIA: K3, K4, K5, Sorento, Sportage  
 Hyundai: Freescale, Coupe, Sonata  
 (9th gen), Santafe



**S/N: NS03**

**MODEL: H7**  
**CAR MODELS:**  
 Volkswagen: Polo, new Touran, new Tiguan  
 MG: Maxplan  
 Skoda: Octavia



**S/N: NS04**

**MODEL: H7**  
**CAR MODELS:**  
 Chery: RIICH 5 ...  
 Mercedes-Benz: C class, B class, GLA  
 class, GL class...  
 Ford: EDGE  
 Pentium: B50, B70, ...



**S/N: NS05**

**MODEL: H7**  
**CAR MODELS:**  
 Nissan: Qashqa  
 Buick: Regal, LaCrosse, Excelle, Hideo, ...  
 Volkswagen: new Jetta, new Magotan, new Bora, ...  
 Mercedes-Benz: E class, ML class  
 Audi: A3, A4L, A6L, ...  
 BMW: new 5 Series, X5, ...



**S/N: NS06**

**MODEL: H7**  
**CAR MODELS:**  
 New Mazda : Mazda 3, 5, 6



**S/N: NS07**

**MODEL: H7**  
**CAR MODELS:**  
 Volkswagen: Golf 6

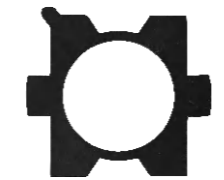

**S/N: NS08**

**MODEL: H7**  
**CAR MODELS:**  
 Geely (low beam): Vision, Global Eagle  
 Lingyue V3, Lingzhi V5,V6,



**S/N: NS09**

**MODEL: H7**  
**CAR MODELS:**  
 New Lavida, new Gran Lavida, new Lamando,  
 new Touran, new Tiguan, ...



**S/N: NS10**

**MODEL: H7**  
**CAR MODELS:**  
 Ford: new Mondeo  
 Peugeot: 508,2008,3008,4008.....  
 Citroen: C5,DS5,DS6



**S/N: NS11**

**MODEL: H7**  
**CAR MODELS:**  
 Hyundai: Mistra, new Azera, Elantra  
 KIA: Carens, Sonata 8

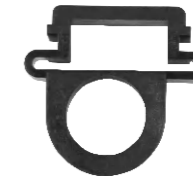

**S/N: NS12**

**MODEL: H1**  
**CAR MODELS:**  
 Ford Focus, Fiesta  
 high beam, for copper strip braided type



**S/N: NS13**

**MODEL: H7**  
**CAR MODELS:**  
 Focus low beam H7



**S/N: NS14**

**MODEL: H7**  
**CAR MODELS:**  
 Ford Kuga, old Magotan  
 HID LED



**S/N: NS15**

**MODEL: H7**  
**CAR MODELS:**  
 Fiat, Land Rover Freelander, MK3,  
 MK35 and 2017 new Focus



**S/N: NS16**

**MODEL: H7**  
**CAR MODELS:**  
 Hyundai Mistra (2017 Low Beam)  
 KIA Carnival (2016 High Beam)



**S/N: NS17**

**MODEL: H7**  
**CAR MODELS:**  
 Senova D50 X55 X25 X65  
 Mercedes-benz B ML Series  
 VW Touareg, Skoda Octavia classic  
 version Opel



**S/N: NS18**

**MODEL: H7**  
**CAR MODELS:**  
 Audi A3,A4L,A6L  
 Buick Lacrosse, Excelle classic version,  
 Excelleg



**S/N: NS19**

**MODEL: H7**  
**CAR MODELS:**  
 Opel, Honda CRV, Mazda



**S/N: NS20**

**MODEL: H7**  
**CAR MODELS:**  
 2017 Jetta, Golf 5