

Contents

1. Usage environment	1
2. Installation Precautions	1
3. Recommended steps	2
4. Menu	2
5. User	2
5.1 Enroll	3
5.2 User View	4
5.3 Dept.	4
5.4 Download enrollmsg	5
5.5 Up.Data	5
6. Shift	6
6.1 Atten rule	6
6.2 Shift	6
6.3 Bell	8
6.4 Log Info	9
7. Report	9
8. System	10
8.1 Device Setup	10
8.2 Advanced setup	11
9. Access	12
9.1 Access	12
9.2 Timezone settings	12
9.2.1 Day timezone.....	12
9.2.2 Week timezone.....	13
9.2.3 Normal open timezone.....	13
9.3 Open Group	13
10. Data Mgt	14
11. Communication	15
11.1 Comm set	15
11.2 Server	15
11.3 Ethernet	16
12. System Information	17
Appendix1 Schematic Diagram of Access Control Wiring	18
Appendix2 Input Method Introduction	18

Thank you for using our products, which adopt the latest biometrics solution and high speed stable ARM processor. The product's recognition, speed and other performance indicators are in the industry leading level, fully meet your efficient work requirements.

- Due to the continuous update of the product, all performance and parameters are subject to the actual product, any change without prior notice. The actual product may be inconsistent with the information, and shall not be liable for any discrepancy between the actual technical parameters and the information.
- The picture description in this document may not match the picture of the product in your hand, please refer to the actual product.

1. Usage environment

- 1) Avoid installing device in a place where strong light is shining. Strong light has influence on face recognition, which may lead to the failure of face recognition verification.
- 2) The operating temperature of the device is 0°C–45°C. Avoid long-term outdoor use. Long-term outdoor use will affect the normal operation of device. If it is must be used outdoors, It is recommended to use sunshade and heat dissipation equipment in summer and heat preservation equipment in winter.

2. Installation Precautions

Fix the rear panel on the wall → Install the device on the rear panel → tighten the screw on the bottom of the machine.

- 1) Before installation, please make sure that the power system of device is turned off during installation. Live installation and wiring operations can cause damage to the machine due to contact with the power cord.
- 2) On the situation that static electricity is a bit heavy, please connect ground wire first and then connect other wires, which can protect the device from damaging in static electricity.
- 3) If do not use some ports of terminals. Please do not expose the lines that connect the unused ports. It may cause short circuit damage to equipment. At the same time, please use different colored lines to connect ports for distinguishing different port.
- 4) Please connect other lines before connecting the power cord, and finally power test. If it is found that the device cannot work normally after power on, the power must be cut and check device and all the lines.
- 5) If the distance between the power supply and the device is far, it is strictly forbidden to use network cable or other special wire instead of power cord.
- 6) When wiring the attendance device, due to abnormal wiring, the device circuit, motherboard and fingerprint scanner are burnt out, which causes the device cannot be used normally, which is not within the scope of warranty.

3. Recommended steps

- 1) Step 1: Open the box to check the device and power on the device. Check for exceptions, set the date and time of the device, and install the device.
- 2) Step 2: Add users and register users' face, card, password, etc.
- 3) Step 3: Set shift.
- 4) Step 4: Set up shift schedule for users.
- 5) Step 5: Download attendance records at the end of month.

4. Menu

Touch the screen and a menu bar will pop up at the bottom of the screen, click  to access into menu, when an admin is registered, After passing the verification of admin's face or card or password then the menu can be entered



- **User :** Enrol user, view user list, department setting, download enrolment data and upload enrolment data.
- **Shift :** records warning setting, grace minimum setting, logs information.
- **Report :** Download attendance reports in Excel format
- **System:** It includes general settings, like time, language settings, and firmware updating
- **Access :** Set Wiegand output format, lock delay , time zone setting and open group setting
- **Data Mgt:** Download records in txt format, delete data and initialize device
- **Comm set :** Set device No. , server setting, Ethernet setting
- **Sys info :** Query registration information and detailed information of device.

5. User

The basic information of the user on the device includes face, card, password and privilege. In attendance management, due to personnel changes. Therefore, the device provides add, delete, change the user and other operations.

Touch the screen and a menu bar will pop up at the bottom of the screen, click  >【User Mgt】,It includes add user, user view, department setting, download enrolment data and upload enrolment data.

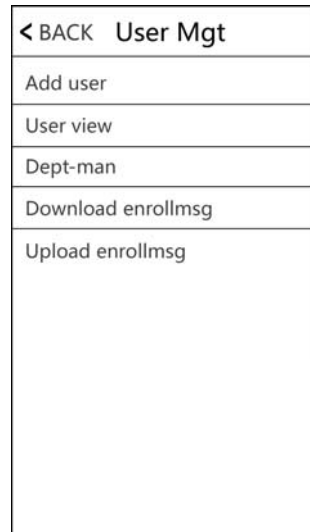

5.1 Enroll

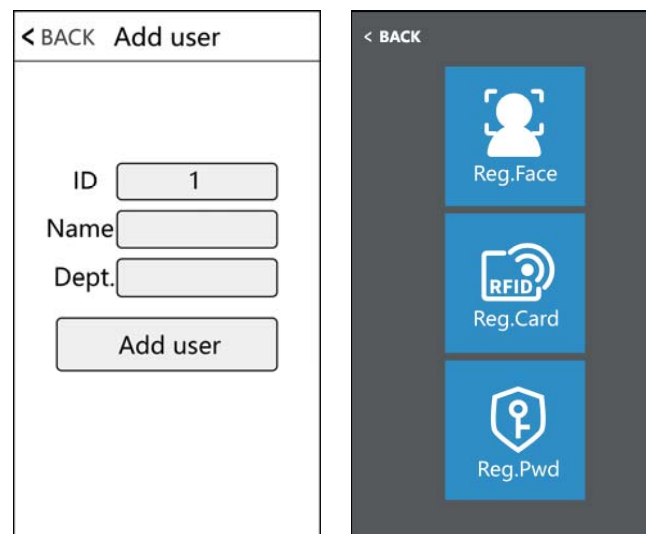

- 1) **ID:** When registering, each user can only have one unique 'ID'.
- 2) **Name:** Input、 edit name by T9 input method.
- 3) **Face:** Follow the on-screen prompt for face registration.

Note: Please stand directly in front of the device, face the camera, and keep the entire face displayed in the frame, In order to maintain a good face recognition effect.The following picture is for your reference

- 4) **Fingerprint:** Press finger three time to finish enrollment
- 5) **Card:** Select Reg.Card and put card on swipe area to register card
- 6) **Password:** An ID can only register one password. After clicking the password icon, enter the password to be set and then press ok to confirm the

password again.

Remark: Verify password by touching the screen then click  then input ID-click 'OK'-input password-click 'OK'

5.2 User View

< BACK Find Find.Name				
ID	Name	Face	Card	PWD
1	Jessica	1	*	✎
2	Sophie	2	*	✎

Pre Next

< BACK Ching(1)	
Edit	Advanced setup
ID	1 
Name	Ching
Card	31061
PWD	
Privilege	User <input type="button" value="Modify Face"/> <input type="button" value="Delete"/>

< BACK Ching(1)	
Edit	Advanced setup
Dept	✎
Shift	No ✎
T.Zone	No ✎
Birthdaty	00/00 ✎
Start:	2000-01-01 ✎
End:	2099-01-01 ✎
GRP	No ✎

Browse all registered persons in the device, click corresponding user to edit its information, including name, password, dept, privilege and access control settings; You can also change face registration information or delete this user, you can quickly locate the user you want to edit by **【Find】** or **【Find Name】** at the top of the page.

Note:For **【Admin】** , User and Admin and Super.user can be selected

User:If there is Admin and Super.user in this device, user is not allow to access into menu

Admin: The manager of this device. Only admin has permission to access into menu.

Super.user : Only when there is Admin in device, then can register Super.user, and

Super.user can only operate part of menu, such as register users

5.3 Dept.

Edit department name, up to 14 departments can be supported

< BACK Dept-man	
---	---
---	---
---	---
---	---
---	---
---	---
---	---
---	---

5.4 Download enrollmsg

Touch the screen and a menu bar will pop up at the bottom of the screen, click  > **【User Mgt】** > **【Download enrollmsg】**, insert U-disk in device to download, 3 files will be exported as below:

- 1、 User data file (AFP_001.dat): It can be used to synchronized users between devices, and '001' represents device ID
- 2、 User's enrolled photo(EnrollPhoto)
- 3、 User information Excel sheet(Staff): Users can edit it in PC then upload back to device, please refer to below picture:

Staff												
Note:A. Enroll number: only fill in the number (maximum of 8) required. B. Name: up to 48 words. C. Department: up to 48 words. D. Shift: 0~8. E. Admin :0 or not filled: user, 1: admin. F.Fingerprint, Face: no need to fill in. G. Password: up to 8 digi												
ID	Name	Dept.	Shift	Admin	Face	PWD	Card	Lock timezone	GRP	Birthdate	Start:	End:
1	Jenny		0	0		123	3653177	0	0			
2	Sophie		0	0		0	0	0	0			

Fill in personnel information according to the prompt of form header. As for “Shift” item, it is the editing shift number in the time attendance setting. When complete the editing. Directly Click **【Save】**, and save the edited file into U-disk.

5.5 Up.Data

After editing shift form, Touch the screen and a menu bar will pop up at the bottom of the screen, click  > **【User Mgt】**, then insert U-disk, click **【Upload enrollmsg】** and transmit the edited user information to device.

Remark: For Lock Time zone, start time and end time, Pls refer to Chapter 9 Access

6. Shift

Touch the screen and a menu bar will pop up at the bottom of the screen, click  > **【Shift】** > **【Atten rule】** , It includes attendance rules ,shift settings, record warning setting, and log information.

6.1 Atten rule

This chapter is used for setting shifts and attendance rules

Touch the screen and a menu bar will pop up at the bottom of the screen, click  > **【Shift】** > **【Atten rules】**

Item	Meaning
Re verify	Check if users make punch repeatedly within this range, if records interval is less than this value, records won't be stored
Log Warning	When rest available storage capacity is less than this value, device will alarm
Save Photo	If select 'Yes', when device connect to cloud software, captured photo when users verify face can be shown in cloud software
Default Shift	Set default shift, when you add users, they will apply this default shift
Excel Pwd	Set password for attendance report
Late time	When user's late arrival time exceeds *** mins , then it is counted as late arrival.
Lea time	When user's early leave time exceeds *** mins , then it is counted as early leave.

6.2 Shift

1) Edit shift (Single shift)

Touch the screen and a menu bar will pop up at the bottom of the screen, click  > **【Shift】** > **【Edit Shift】**

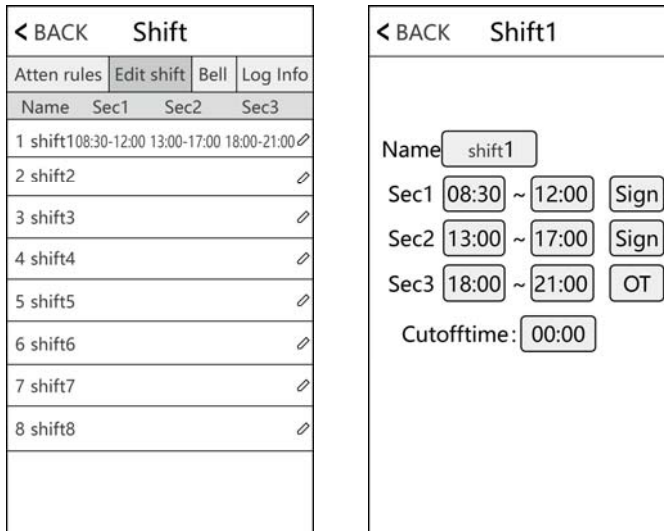

According to real work time to edit shift, section status can be set as sign(normal attendance) or overtime.

2) Edit Shift (Multiple shifts)

When there are multiple shifts, we recommend downloading shift sheet to edit shift, edit all shifts through the shift sheet and upload them back to the device to avoid tedious operations on the device. Specific operations are as follows:

1. **【Download Shift】** : Touch the screen and a menu bar will pop up at the bottom of the screen, click  > **【Shift】** > **【Atten rules】** , then insert U-disk. Click **【Download Shift】**, then you can download shift arrangement in excel form, Also you can edit the form on PC. Pls refer to below picture:

Shift											
Note: A, shift name: up to 48 words. B. Section type: 0: normal attendance.1: overtime. C. cut off time: if the punch before the cut off time ,it will calculate as the previous day											
NO.	Name	Sec1			Sec2			Sec3			Cutofftime:
		IN	OUT	Sec_t ype	IN	OUT	Sec_t ype	IN	OUT	Sec_t ype	
1	Day Shift	08:30	12:00	0	13:30	18:00	0	18:30	21:00	1	00:00
2	Night Shift	22:00	06:00	0							07:00
3	Half Day	08:00	12:00	0							00:00

Edit shift arrangement according to the prompts of form header. Maximum 8 shifts can be set. Click **【Save】** after editing and save the file into U-disk.

Note:

- 1) Attendance time must be in the format of time, and attendance type must be in the format of digits. So when you handle the setting, pls pay attention that the input

method is in English half-angle status. Checking Method: For example, when you input 10:30, double click this cell, then software will automatically turn the digits into 10:30:00.

2) If you set the shift of cross time, then the Clock-in before the cross time will be counted as the record of previous day. And shift should start after the cross time. For example:

Shift											
Note: A, shift name: up to 48 words. B. Section type: 0: normal attendance.1: overtime. C. cut off time: if the punch before the cut off time ,it will calculate as the previous day											
NO.	Name	Sec1			Sec2			Sec3			Cutofftime:
		IN	OUT	Sec_t ype	IN	OUT	Sec_t ype	IN	OUT	Sec_t ype	
1	Shift1	23:00	08:00	0							09:00

Cross time is set at 09:00am. Then shift should start after 08:00, and Clock-in record before 09:00am on Tuesday should be counted as the record of Monday.

3) If you don't need to clock at noon, combine the two sections into one . For example: 08: 30-12: 00 13: 30-17: 50,it can be set to section 1: 08: 30-17: 50

4) Time Skip setting is not allowed. For example, When you complete the setting of Section 1, you cannot skip Section 2 and get to set Section 3.

2. 【Upload shift】 : After editing, insert U-disk and click 【Upload Shift】 , then you can upload the edited shift arrangements into device.

6.3 Bell

Touch the screen and a menu bar will pop up at the bottom of the screen, click



> 【Shift】 > 【Bell】 , Up to 24 groups of scheduled ring time. Touch the bell time to enable it.

< BACK Shift	
Atten rules	Edit shift Bell Log Info
Bell time	📄
Bell count	0 📄
Bell output	No 📄

6.4 Log Info

Input the user ID and time range to query records of the corresponding user

7. Report

Touch the screen and a menu bar will pop up at the bottom of the screen,

click  > **Report** , Insert U-disk, and input the start and end time that you need to check. Click “OK” to download the report. The report includes original record sheet(Original Record), attendance list(Schedule)and summary sheet(Summary Report).

Original Record: You can check all users’ attendance records in the sheet. Pls refer to below picture:

Original record																																
Date:2019-8-1~2019-8-31																																
ID:1 Name:Lucas Dept.:Office Shift:Day Shift																																
1	2	3	4	5	6	7	8	9	10	11	12	13	14	15	16	17	18	19	20	21	22	23	24	25	26	27	28	29	30	31		
08:25	08:25	08:25	08:25	08:25	08:25	08:25	08:25	08:25	08:25	08:25	08:25	08:25	08:25	08:25	08:25	08:25	08:25	08:25	08:25	08:25	08:25	08:25	08:25	08:25	08:25	08:25	08:25	08:25	08:25	08:25	08:25	08:25
12:03	12:03	12:03	12:03	12:03	12:03	12:03	12:03	12:03	12:03	12:03	12:03	12:03	12:03	12:03	12:03	12:03	12:03	12:03	12:03	12:03	12:03	12:03	12:03	12:03	12:03	12:03	12:03	12:03	12:03	12:03	12:03	
13:26	13:26	13:26	13:26	13:26	13:26	13:26	13:26	13:26	13:26	13:26	13:26	13:26	13:26	13:26	13:26	13:26	13:26	13:26	13:26	13:26	13:26	13:26	13:26	13:26	13:26	13:26	13:26	13:26	13:26	13:26	13:26	
18:04	18:04	18:04	18:04	18:04	18:04	18:04	18:04	18:04	18:04	18:04	18:04	18:04	18:04	18:04	18:04	18:04	18:04	18:04	18:04	18:04	18:04	18:04	18:04	18:04	18:04	18:04	18:04	18:04	18:04	18:04	18:04	

Schedule: Attendance machine can automatically analysis the clock-in and clock-out data, and transmit these data in EXCEL file to the U disk. Format as below:
 (Remark: Red text indicates that the attendance is abnormal, such as late, early leave. Blue means overtime)

schedule												
ID:1		Name:Lucas										
Dept.:Office			Shift:Day Shift					Date:2019-8-1~2019-8-31				
Date	week	Sec1		Sec2		Sec3		Work hours		OT hours	Late minutes	Leave minutes
		IN	OUT	IN	OUT	IN	OUT	Normal	Actual			
8-1	THU	08:25	12:03	13:26	18:04			8	8	0	0	0

Original record / **schedule** / Summary Report

Summary Report: It is a Statistics display of employee attendance for one month

Summary Report												
Date: 2019-8-1~2019-8-31												
ID	Name	Dept.	Work hours		Late minutes		Leave minutes		OT hours		Work Dates(Normal /Actual)	Truancy
			Normal	Actual	TIMES		Minutes	TIMES	Minutes	Normal		
1	Lucas	Office	248.0	248					77.5		31.0/31.0	0

Original record / schedule / **Summary Report**

8. System

Touch the screen and a menu bar will pop up at the bottom of the screen, click



> **【System】**

8.1 Device Setup

Item	Meaning
Time	Set device time
Time fmt	24H and 12H format can be selected
Date fmt	Select different date format
Language	Change device displayed language
Voice	Set the volume of speaker
Play name voice	if play user name after verifying success
Multiple face	If set it to yes, device can verify multiple users(up to 5) at the same time
Result time	When the user' s face is always displayed on the screen, how long does it take for the device to verify the face again, if set to 0s, device will only recognize once in the situation and it won't be recognized until face moves off screen and appears again
Screen Idle	How long does it take to enter screen saver when the main

	Interface is not operating
Screen Saver Wake up	When device displays screen saver, the user can choose to wake up the device when the device detects the face or touch screen
bio-assay	Verify that the user is a live person instead of photo.
Show Avatar	Whether to show user's photo or not on the screen after verifying successfully

8.2 Advanced setup

Item	Meaning	
Max Admin	Set the maximum number of device admin	
Verify Mode	FA/C/P	No matter what kind of verification method can be verified
	Others	Need to verify two verification methods together
Visitor QRCode	Whether enable scanning QRcode function or not. Connect device to our cloud software and generate QRCode then verify it in device	
1:N Identify	Set the threshold of face recognition	
Live threshold	When enable 'bio-assay', the threshold of face recognition	
Wear mask	No	Device will not detect mask
	Yes	Users can wear a mask or not wear a mask to verify, if wear mask, the threshold of face recognition is same as 'mask threshold' settings
	Must	Device will detect mask, if user doesn't wear mask, device will not accept it
Mask threshold	When wearing a mask, the threshold of face recognition	
Exposure Compensation	When device is in dark light and backlight environment , can change this value to adjust camera	
Testing	Check whether the camera is normal	
Camera calibration	Calibrate camera	
Firmware upgrade	Insert U-disk (FAT32 format) to do device firmware upgrade	

9. Access

Touch the screen and a menu bar will pop up at the bottom of the screen, click



> **【Access】**

9.1 Access

Item	Meaning
OD delay	Set the time between lock relay effective and the state of resume normal.
Sensor Mode	Set the type of door sensor, the default setting is 'No'.
Sensor Delay	When door status is opposite to sensor mode and keep this status for more than sensor delay, device will alarm
Users	Set the number of user required to open the door. For example: set it to 2, only when 2 different users verify at the same time, the door can be opened
Anti pass	Anti pass function will be activated when it is set as in, out or two way
Wg output	Define the content of wiegand output, user ID and card number can be selected
Wg format	You can define wiegand port output format. The default format is 34bits, and it can be changed to 26bits
External Wg input	Connect external wiegand reader

9.2 Timezone settings

9.2.1 Day timezone

According to the rules and regulations of user's entry and exit, set the daily access time to the corresponding time period. You can totally set 8 groups of day time zones, or week time zones. For example, you can set the time between 6:00am and 8:00am to open the door, and the time between 17:00pm and 19:00pm to open the door. Pls refer to below picture Day Timezone 1 setting. If you want to set the door to be open in all day, pls refer to below picture Day Timezone 2 setting.

Example: 【Day Timezone 1】 setting as below

T.Zone1	06:00	08:00
T.Zone2	17:00	19:00
T.Zone3	00:00	00:00
T.Zone4	00:00	00:00
T.Zone5	00:00	00:00

Example: 【Day Timezone 1】 setting as below

T.Zone1	00:00	23:59
T.Zone2	00:00	00:00
T.Zone3	00:00	00:00
T.Zone4	00:00	00:00
T.Zone5	00:00	00:00

9.2.2 Week timezone

According to the rules and regulations of user's entry and exit, Set the passage time of each week to the corresponding day time zone. For example, the above-mentioned daily time zone rule(only 6:00am to 8:00am can open the door, and only 17:00pm to 19:00pm can open the door) applies from Monday to Friday, and door can be opened all day on Saturday and Sunday. Pls refer to (Figure 1) for Week Timezone 1:

Week Timezone	
SUN	2
MON	1
TUE	1
WED	1
THU	1
FRI	1
SAT	2

(Figure 1)

Normal Open Time	
SUN	1
MON	1
TUE	1
WED	1
THU	1
FRI	1
SAT	1

(Figure 2)

Remark: In our device, 【Week Timezone 0】 is default to open the door all day. All other time zones are customizable

9.2.3 Normal open timezone

According to requirements, Set the passage time of each week to the corresponding day time zone .Example: If the setting is as (Figure 2), Day time 1 applies to every day , then it means the door is kept open between 6:00 am and 8:00 am and 17:00pm to 19:00pm everyday

9.3 Open Group

Example: Set open group1 to 12, it means in the definition of user access control in the above section, it is defined that one from group 1 and another one from group 2 together to verify that

can open the door

Example 1: Single one can open the door

Open group 1	1
Open group 2	0
...	
Open group 5	0

In the above Settings, which means that only users belonging to group 1 have access to the door.

Example 2: Multiple users who from the same group must together to verify that can open the door

Open group 1	111
Open group 2	0
...	
Open group 5	0

In the above Settings, which means that need 3 users belonging to group 1 must together to verify that have access to the door.

Example 3: Different users from different groups

Open group 1	12
Open group 2	0
...	
Open group 5	0

In the above Settings, which means that need 2 users that one belonging to group 1 and another one belonging to group 2 must together to verify that have access to the door.

Users belonging to group 1 and users belonging to group 2 do not have the right to open the door independently.

10. Data Mgt

Touch the screen and a menu bar will pop up at the bottom of the screen, click  > **【Data Mgt】**, Data management consists of 6 modules: Download Glog、Download All Glog、Clear All Enroll、Delete All Glog、Initialize Menu、Clean Manager.

【Down Glog】:New attendance logs saved in device can be downloaded to U-disk, and form a TXT file, eg:'GLG_001.TXT'

【Down All Glog】:All attendance logs saved in device can be downloaded to U-disk, and form a TXT file, eg:'AGL_001.TXT'

【Clear All Enroll】:Delete all registration info of all users(include face、 card and pwd)

【Delete All Glog】: Delete all logs of all users

【Initialize Menu】: Reset device parameter settings, it won't affect user data and records

【Clean Manager】: Clear all manager privileges on the device

11. Communication

Touch the screen and a menu bar will pop up at the bottom of the screen, click









> **【Comm set】**

11.1 Comm set

< BACK Comm set
Comm set
Server
Ethernet

Item	Meaning
Device ID	Set corresponding device No., the default device No. is 1, Please note that the number is related to the communication
Port No.	The default port No. is 5005, For communication connection under LAN

11.2 Server

← BACK Server	
Server Req	No 
Use domainNm	No 
DomainNm	192.168.0.110 
Server IP	192.168.000.122 
SerPortNo	7788 
Heart beat	3 
Server approval	No 

When using WAN connection, please do corresponding server settings

Item	Meaning
Server Req	Select 'Yes' or 'No', select 'yes' to enable server communication
Use domainNm	Select 'Yes' or 'No'
DomainNm	If you select 'Yes' for 'Use domain Nm', enter the server domain name here
Server IP	If you select 'No' for 'Use domain Nm', enter the server ip address here
SerPortNo	Enter server port number
Heartbeat	Default value is 3s
Server approval	If set it to yes, only when device connect to server can users make punch in device

11.3 Ethernet

Use Ethernet to connect the device to computer. An example is shown in the figure below:

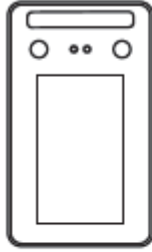

IP Address: 192.168.1.224
 Subnet Mask: 255.255.255.0
 Gateway: 192.168.1.1



IP Address: 192.168.1.100
 Subnet Mask: 255.255.255.0
 Gateway: 192.168.1.1

12. System Information

Touch the screen and a menu bar will pop up at the bottom of the screen, click



> **【Sys info】**, query registration information and detailed information of device.

< BACK Sys info		
Capacity	Info	
Manager	0	10
Add user	7	2000
Face	6	2000
Card	119	2000
PWD	450	2000
G_Log	119	1000000
All log quantity	450	1000000

< BACK Sys info	
Capacity	Info
Company	
Web Site	
No	ZX0006828566
Released	19 Jan 2021
Model	fp50v
Firmware	ai806_fp50v_v2.00
Engine	AiFace_v3.10

Appendix1 Schematic Diagram of Access Control Wiring

1) Schematic diagram of device wiring port

(According to the number of port to select corresponding wiring diagram)

8 pin port:

Red	12V	12V
Black	GND	GND
Green	Lock COM	The common end of the lock signal
Orange	Lock NC	Normal closed end of the control signal
Blue	Lock NO	Normal opened end of the control lock signal
Yellow	Button	Exit button
Brown	D-Sensor	Door sensor
White	ALARM-	Output alarm signal

6 pin port:

Red	12V	12V
Black	GND	GND
Orange	WG_IN0	Wiegand input 0
Yellow	WG_IN1	Wiegand input 1
Green	WG_OUT0	Wiegand output 0
White	WG_OUT1	Wiegand output1

4 pin port:

TCP_TX+	TCP/IP Interface
TCP_TX-	
TCP_RX+	
TCP_RX-	

2) Device connection diagram

(According to the number of port to select corresponding wiring diagram)

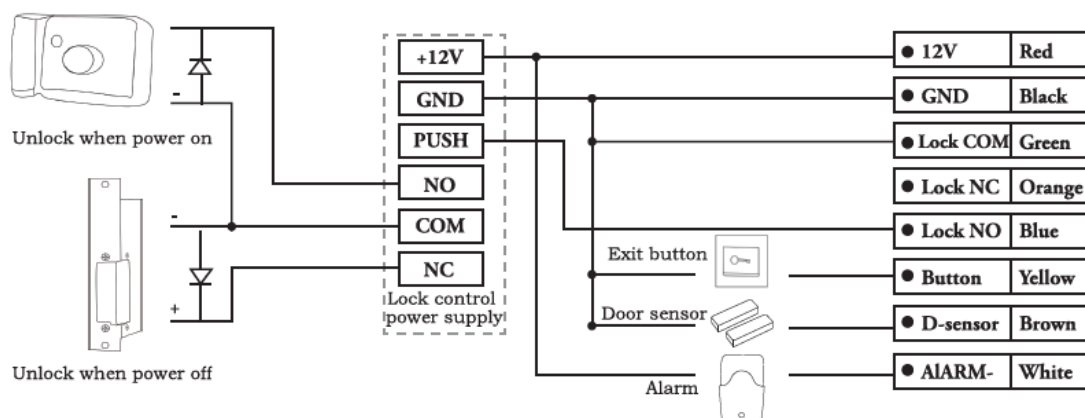

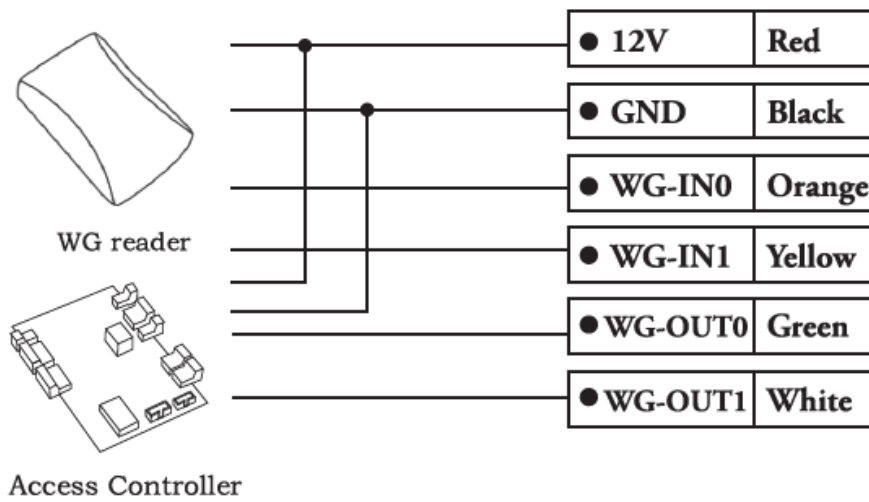

Remark: When the power supply of the access controller is insufficient (The facial device may shut down automatically when face recognition happens) . In this case, please wiring as below diagram:

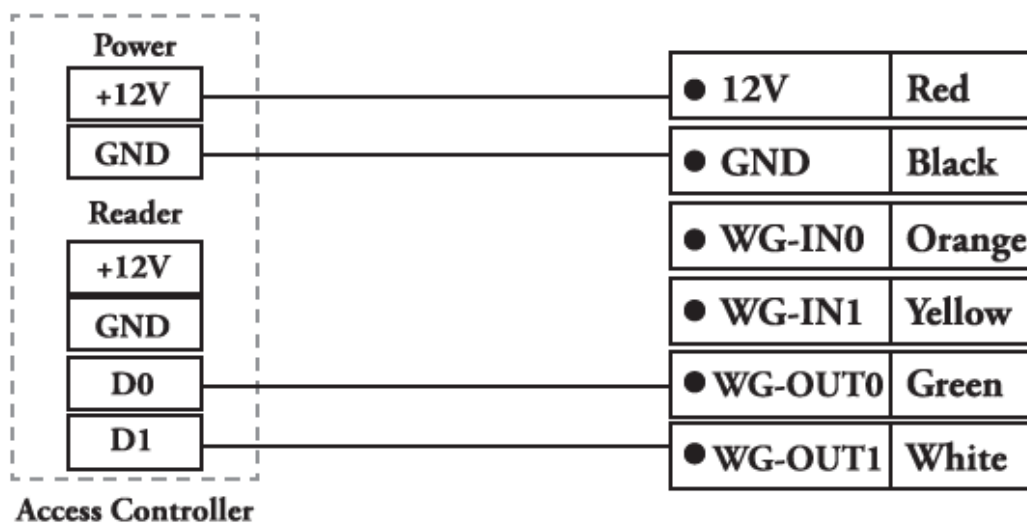

Appendix2 Input Method Introduction

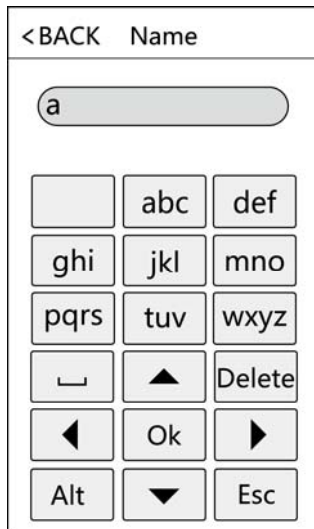

Touch 'Alt' to switch capital/small letter or number, after finished,touch 'Ok' to save it
How to input punctuation:when the input method is in capital/small letter state,touch '└' to select what you want to input. The first one is space, the second is dot and so on