



Appearance Patent No.: ZL 201730674512.0

V1.7

ANGULAR GYRO SENSOR
RION TL740D
Technical Manual



RION QUALIFICATION CERTIFICATION

- Quality management system certification: GB/T19001-2016 idt ISO19001:2015 standard (certificate No.: 128101)
- High-tech Enterprise (Certificate No.: GR201844204379)
- CE certification: registration No.: AT18250EC100019
- China National Intellectual Property Appearance Patent (patent No.: ZL 201730674512.0)
- Revision date: 2021-7-17

Note: Product functions, parameters, appearance, etc. will be adjusted as technology upgrades. Please contact our sales to confirm when purchasing.

TL740
ANGULAR GYRO SENSOR

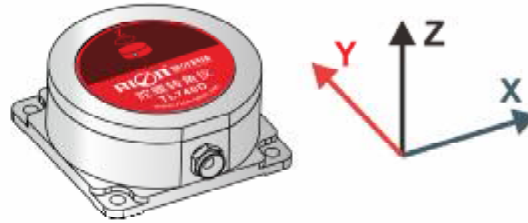

□ **GENERAL DESCRIPTION**

TL740D is RION-TECH newly developed horizontal azimuth angular gyro sensor based on latest MEMS inertial measurement platform , by means of the dynamic attitude algorithm for the angular velocity of gyroscope ,it can simultaneously output carrier's azimuth angle .The product internal integrated RION's Patent Inertial navigation algorithm, through the model of attitude angle data fusion , can solve the gyro short time drift problem as much as possible .

This product is specially used for robot car, AVG vehicle azimuth orientation, attitude control and other related applications of the UAV, instead of the traditional robot vehicle magnetic bar guide shortcomings, no need at the site layout of magnetic stripe, is the necessary navigation components for the next generation of robot vehicle automatic tracing and driving.

□ **KEY FEATURES**

- | | | |
|------------------------------|-------------------------------|------------------------|
| ★ Azimuth angle output | ★ Strong vibration resistance | ★ Light weight |
| ★ Long life,strong stability | ★ Cost-effective | ★ All solid state |
| ★ Compact & light design | ★ RS232/RS485 output optional | ★ DC9~36V power supply |

□ **APPLICATION**

- | | | |
|---|----------------------|----------------------|
| ★ AGV truck | ★ Car Navigation | ★ 3D virtual reality |
| ★ Platform stability | ★ Auto safety system | ★ UAV / Robot |
| ★ Turck-mounted satellite antenna equipment | | ★ Industrial control |



□ **TECHNICAL DATA**

TL740D	PARAMETERS
Mesuring range	Azimuth Angle (±180°)
Acquisition bandwidth	>100Hz
Resolution	0.01°
Azimuth accuracy	<0.1°/min
positional accuracy	<2mm/m (converted from angle accuracy)
Nonlinear	0.1% of FS
Max angle rate	150°/s
Accelerometer range	±4g
Accelerometer resultuion	0.001g
Accelerometer accuracy	5mg
Starting time	5s (Static)
Input Voltage	+9V~36V
Current	60mA(12V)
Working Temp.	-40 ~ +85℃
Storage Temp.	-40 ~ +85℃
Vibration	5g~10g
Impact	200g pk , 2ms , ½sine
Working life	10 years
Output rate	5Hz / 15Hz / 25Hz / 50Hz / 100Hz Can set
Output signal	RS232 / RS485 / TTL (Optional)
MTBF	≥50000 hours /times
Insulation resistance	≥100 Megohm
Impact resistance	100g@11ms、 3 Axial Direction (Half Sinusoid)
Anti-vibration	10grms、 10 ~ 1000Hz
Protecting	IP67
Weight	130g(Without cable)

□ **ORDERING INFORMATION**

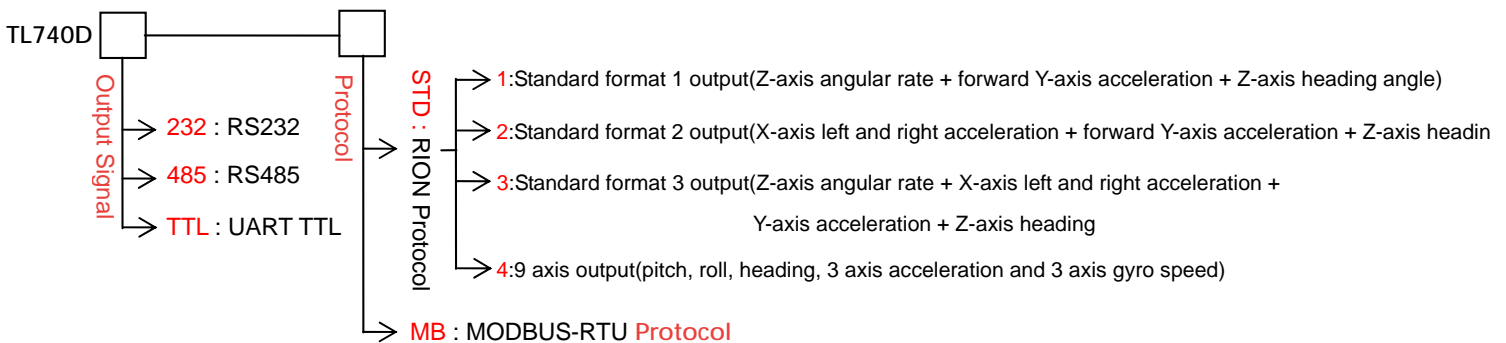

E.g :TL740D-232-STD1 : RS232Output Interface/RION Protocol Standard format 1 output.

□ ELECTRICAL CONNECTION

LINE COLOR FUNCTIONS	BLACK	WHITE	GREEN	RED
	GND Power Negative	RS232(RXD) RS485(D+)	RS232(TXD) RS485(D-)	Vcc 9 ~ 36V Power Positive

□ SZIE

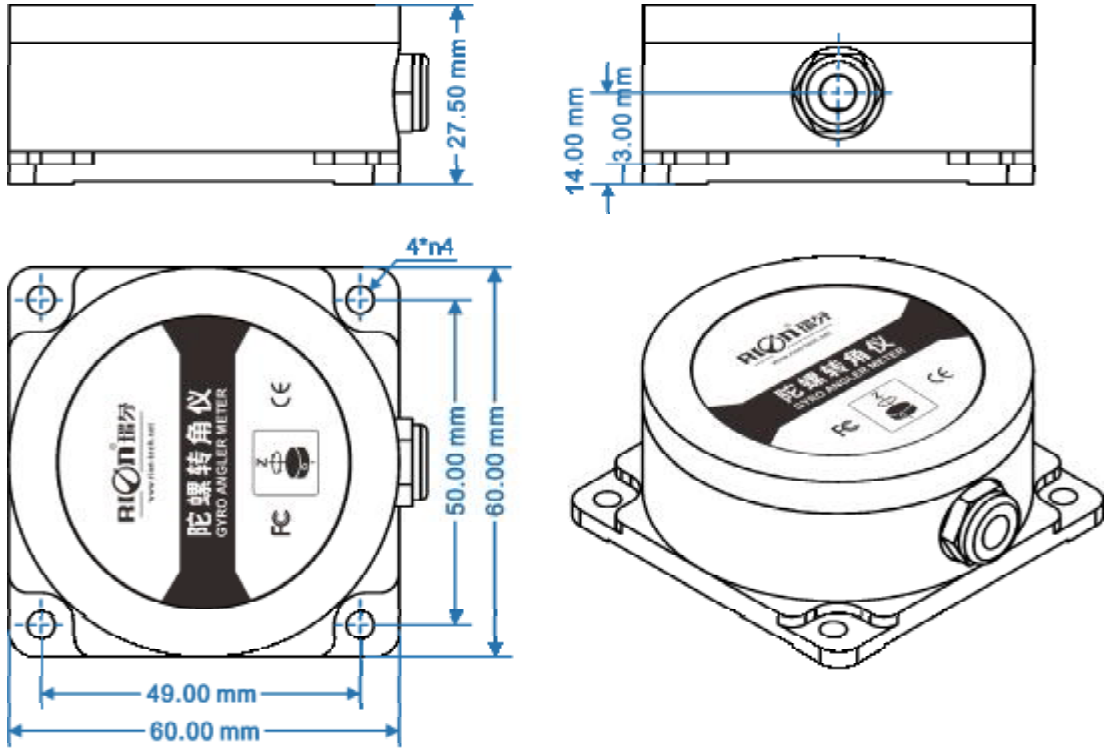

Shell size: L60×W60×H27.5mm
 Installation size: L49*W50*H40mm
 ounting screws: 4 M4 screws

□ INSTALLATION DIRECTION

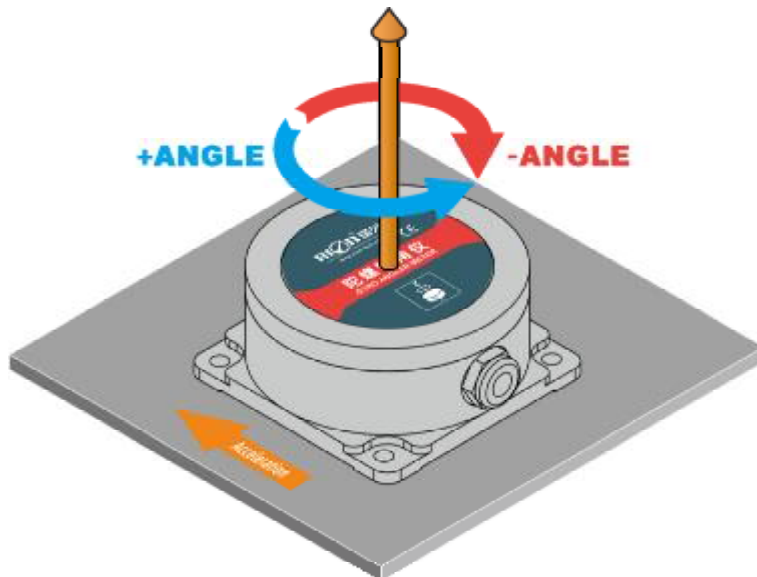

□ **INSTALLATION PRECAUTIONS**

1. The angular gyro sensor should be mounted in the center position of the measured object , in order to reduce the influence of linear acceleration on the measurement accuracy. See below diagram as ref.

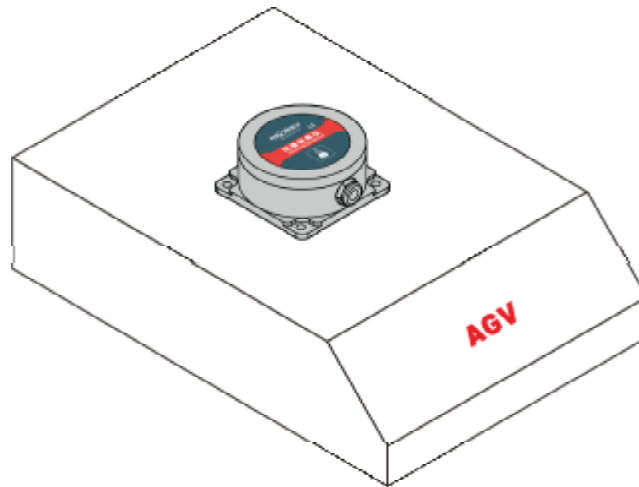

The gyro goniometer is installed in the geometric center of the AGV vehicle

2. The installation of the instrument should be kept parallel to the surface of the measured object, and reduce the influence of the dynamic and acceleration on the angle meter. Incorrect installation will lead to measurement errors, with particular attention to "surface" and "line "

① The mounting surface of the instrument fixing must be close, smooth and stable with the measured surface. If the mounting surface is not smooth, the angle error of angle measurement can be caused easily. See figure Pic.AB

② The axis of the instrument must be parallel to the axis of measurement, and the two axis should not be included angle as far as possible , see figure Pic.CD

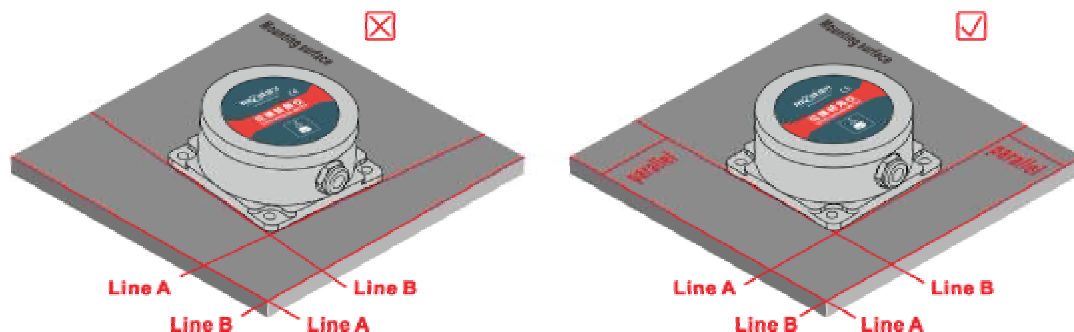
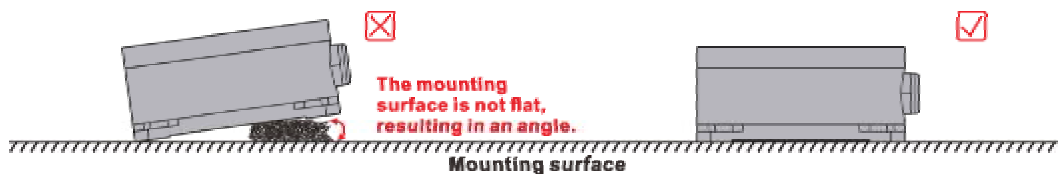

3. Do not shake violently during the use of the product, avoid violent vibration, away from the vibration source (if you can not avoid please install the shock absorber), so as not to affect the product measurement accuracy;

4. Try to avoid a sharp acceleration, arrest, sharp turn angular velocity greater than 300 DEG /s movement during use, so as not to affect the measurement precision of products.

□ RION 68 COMMUNICATION PROTOCOL

1. Data Frame Format

(8 bits date , 1 bit stop , No check , Default baud rate 15200)

Identifier (1byte)	Date Length (1byte)	Address code (1byte)	Command word (1byte)	Date domain	Check sum (1byte)
68H					

Identifier : Fixed68H;

Data length : From data length to check sum (including check sum) length;

Address code : Accumulating module address , Default :00;

Date domain will be changed according to the content and length of command word;

Check sum : Data length、 Address code、 Command word and data domain sum,No carry.

Note: Because of this product at startup need attitude calculation model of internal construction, so start the required time of 5 seconds, and need to maintain the "angle meter" static (no movment), if move the product within 5 seconds process, is re-start time of 5 seconds, after finishing the start process, automatic output data packet, can not output data packet in the start of 5 seconds process .

2. Command analysis

Desc.	Meaning/Example	Description
0X04	Simultaneous reading angle command E.g: 68 04 00 04 08	Data domain (0byte) No data domain command
0X84	Sensor automatic output angle	for detailed information, please check the output format table Note: The data output format is set by the manufacturer according to customer requirements.
0X0C	Setting sensor output mode Auto output mode: The sensor with power on can automatically output angle , output rate 25HZ(factory default). (Power off with save function) E.g: 68 05 00 0C 03 14 Set 25HZ output	Data domain 00 0Hz Q&a output mode 01 5Hz Auto output mode 02 15Hz Auto output mode 03 25Hz Auto output mode 04 35Hz Auto output mode 05 50Hz Auto output mode 06 100Hz Auto output mode
0X8C	Sensor answer reply command E.g: 68 05 00 8C 00 91	Data domain (1byte) Data domain in the number means the sensor response results 00 Success FF Failure
0X0B	Set the baud rate E.g: 68 05 00 0B 03 13 The command setting is effective after power off then restart	Data domain (1byte) Baud rate : 02 means 9600 03 means 19200 04 means 38400 05 means 115200(factory default)
0X8B	Sensor answer reply command E.g: 68 05 00 8B 90	Data domain (1byte) Data domain in the number means the sensor

		response results
		00 Success FF Failure
0X28	Azimuth clear command When the azimuth angle has errors after long time work, you can send this command. After the transmission is successful, the azimuth angle will reply "0°" E.g: 68 04 00 28 2c	Data field no
0X28	Sensor response reply command E.g: 68 05 00 28 00 2D	Data field (1byte) The number in the data field indicates the result of the sensor response 00 Success FF Failure
0x0F	Modify sensor address E.g: 68 05 00 0F 05 19 Change the sensor address from 0x00 to 0x05	Data field (1byte) Address (00-FE), FF is the universal address. In the example, the modified address is: 05
0x8F	Sensor response command E.g: 68 05 00 8F 00 94	Data field (1byte) The number in the data field indicates the result of the sensor response 00 Success FF Failure

3. Detailed output format table

9 axis output: attitude angle 3 axis acceleration 3 axis gyro speed ;

SOF	0x68 (1 byte)				
Length	0x1F (1 byte)				
Address	0x00 (1 byte)				
Payload Contents:	See below:				
Byte Offset	Number Format	name	content	bytes	
0	INT8U	command	0x84	1	Representing data
1	INT8U	ROLL	Roll angle	3	10 50 23: 3 characters-50.23°
4	INT8U	PITCH	Pitch angle	3	01 60 00: 3 characters+160.00°
7	INT8U	YAW	Heading	3	11 60 00: 3 characters-160.00°
10	INT8U	ACC X	X-axis acceleration	3	00 23 04 : 3 characters Acceleration+2.304g
13	INT8U	ACC Y	Y-axis acceleration	3	10 23 04 : 3 characters Acceleration-2.304g
16	INT8U	ACC Z	Z-axis acceleration	3	10 23 04 : 3 characters Acceleration-2.304g
19	INT8U	Gyro_ X	X-axis gyro	3	10 50 23: 3 characters-50.23°/S
22	INT8U	Gyro_ Y	Y-axis gyro	3	01 80 00: 3 characters+180.00°/S
25	INT8U	Gyro_ Z	Z-axis gyro	3	00 50 23: 3 characters+50.23°/S
28	INT8U	Check sum	Checksum	1	

Standard format 1 output

SOF	0x68 (1 byte)				
Length	0x0D (1 byte)				
Address	0x00 (1 byte)				
Payload Contents:	See below:				
Byte Offset	Number Format	name	content	bytes	
0	INT8U	command	0x84	1	Representing data
1	INT8U	Gyro_Z	Z-axis angular rate	3	10 05 23: 3 characters-5.23°/S 00 05 23: 3 characters+5.23°/S
4	INT8U	ACC_Y	Forward body acceleration	3	00 10 00: 3 characters+1.000g 10 10 00: 3 characters-1.000g
7	INT8U	YAW	Azimuth	3	11 60 00: 3 characters-160.00° 01 60 00: 3 characters+160.00°
10	INT8U	Check sum	Checksum	1	

Standard format 2 output

SOF	0x68 (1 byte)				
Length	0x0D (1 byte)				
Address	0x00 (1 byte)				
Payload Contents:	See below:				
Byte Offset	Number Format	name	content	bytes	
0	INT8U	command	0x84	1	Representing data
1	INT8U	ACC_X	Left and right body acceleration	3	00 00 50: 3 characters+0.050g (right) 10 00 50: 3 characters -0.050g (left)
4	INT8U	ACC_Y	Forward body acceleration	3	00 10 00: 3 characters+1.000g (front) 10 10 00: 3 characters-1.000g (back)
7	INT8U	YAW	Azimuth	3	11 60 00: 3 characters-160.00° (Clockwise) 01 60 00: 3 characters+160.00° (Counter-clockwise)
10	INT8U	Check sum	Checksum	1	

Standard format 3 output

SOF	0x68 (1 byte)				
Length	0x10 (1 byte)				
Address	0x00 (1 byte)				
Payload Contents:	See below:				
Byte Offset	Number Format	name	content	bytes	
0	INT8U	command	0x84	1	Representing data
1	INT8U	Gyro_Z	Z-axis angular rate	3	10 05 23: 3 characters-5.23°/S 00 05 23: 3 characters+5.23°/S
4	INT8U	ACC_X	Left and right body acceleration	3	00 00 50: 3 characters +0.050g (right) 10 00 50: 3 characters -0.050g (left)
7	INT8U	ACC_Y	Forward body acceleration	3	00 10 00: 3 characters +1.000g (front) 10 10 00: 3 characters -1.000g (back)
10	INT8U	YAW	Azimuth	3	11 60 00: 3 characters-160.00° (Clockwise) 01 60 00: 3 characters+160.00° (Reverse time)
13	INT8U	Check sum	Checksum	1	

□ RION MODBUS-RTU COMMUNICATION PROTOCOL

1. Modbus-Rtu Data Frame Format : (RTU mode, communication parameters: baud rate 115200 bps, data frame: 1 start bit, 8 data bits, even parity, 1 stop bit)

Please read the following items carefully before use:

1) As the MODBUS protocol stipulates that two data frames should be at least 3.5 byte time, such as 9600 baud rate, the time is $3.5 \times (1/9600) \times 11=0.004s$. But in order to leave enough allowance, the sensor increases this time to 10ms, so leave at least a 10ms interval between each of the data frames. The master sends commands ---10ms idle --slave response command --10ms idle -host machine sends command.....

2)MODBUS protocol stipulates the broadcast address ----relevant 0 content s --- the sensor can also accept the content of the broadcast address, but it will not be answered. So the broadcast address 0 can be used as the following use only for reference.

1. The address of all the model inclinometer sensors mounted on the BUS is set to a certain address.
2. Azimuth of all the model inclinometer sensors mounted on the BUS is ZERO .

3)In order to improve the reliability of the system, set the address command and set up the baud rate, the two commands must be sent two times in a row to be valid. "Two consecutive send" refers to two times sent successfully (the slave reply every time), and the two times replies must be consecutive in two, that the master can not ask into the middle of the other frames, otherwise, the command will be locked until the power off , setting process as below :

Sending the set address command -- waiting for the set of successful commands sent by the slave -- (no other commands can appear), then send the set address command again -- waiting for the set of successful commands from the slave -- the modification is successful.

4)After power supply, the above two sets of commands can only be set once, if you need to set up again, you need to reconnect.

2. Read angle data :

Modbus Function code 03H

Master query command :		Slave response :		
Sensor add	01H	Sensor add	01H	
Function code	03H	Function code	03H	
Access register first address	00H	Data length 12 bytes	0CH	
	02H	Data word 1 high 8 bits	F3H	Z axis angular rate data (azimuth rate)
Data length 6 bytes	00H	Data word 1 Low 8 bits	49H	
	06H	Data word 2 high 8 bits	02H	
CRCLH	6408H	Data word 2 Low 8 bits	00H	Y axis acceleration data (forward)
		Data word 3 high 8 bits	1DH	
		Data word 3 Low 8 bits	4EH	
		Data word 4 high 8 bits	00H	
		Data word 4 Low 8 bits	00H	Z axis azimuth data
		Data word 5 high 8 bits	02H	
		Data word 5 Low 8 bits	4FH	
		Data word 6 high 8 bits	00H	
		Data word 6 Low 8 bits	00H	
		CRCLH	501CH	

An example of reading the command of measurement data1 :

Master send				01 H	03 H	00 H	02 H	00 H	06 H	64H	08H	
Slave response												
01H	03 H	0CH	F3H	49 H	02H	00 H	1DH	4EH	00H	00 H	02H	4FH
00H	00H	50H	1CH									

Note: The data fields from the master reply frame are 50H, 46H, 00H, 00H, 23H, 20H, 00H, 00H.
 The Z axis rate data (azimuth rate) is the 1-4 byte of the data domain. Y axis acceleration data (forward) is the 5-8 byte of the data domain, and the Z axis azimuth data is the 9-12 byte of the data domain, and the low byte is in front.

Z axis angular rate data (azimuth rate) of the representation for the point representation, one point corresponding to 0.01°/s, 0.01×(- points -offset) is the angular rate. The offset angle rate of 150000, a total of 150000 points to 300000 points, so 150000 corresponding 0°/s, 151000 corresponding to +10°/s, 149000 corresponding to -10°/s. ..

The representation of the Y axis acceleration data (forward) is the point number representation, a point corresponding to the 0.001g, and 0.001× (point number-- offset) is the acceleration. The acceleration offset is 20000, and the total number of points is 40000 points, so 20000 corresponds to 0g, 20100 corresponds to +0.100g, and 19900 corresponds to -0.100g.

Z axis azimuth data representation method is point representation, a point corresponding to 0.01° , 0.01×(points - offset) for azimuth. Offset azimuth angle of 18000, a total of 18000 points to 36000 points, so 18000 corresponding 0°/s, 19000 corresponding to +10° , 17000 corresponding to -10°/s ..

Take the above data frame as an example: the process of data conversion is as follows:

- 1) Get the current angle of points. Note that the low byte in front , Z angle rate data is 249F3H, the Y axis acceleration data (forward) is 4E1DH, and the Z axis azimuth data is 4F02H.
- 2) Conversion to decimal, Z axis angular rate: 249F3H →150003, Y axis acceleration: 4E1DH →19997, Z axis azimuth: 4F02H →20226. .
- 3) minus offset, Z axis angular rate: (150003-150000) ×0.01=0.03°/s; Y axis acceleration data: (19997-20000) ×0.001 = -0.003g; Z axis azimuth data: (20226-18000) ×0.01=22.26°
- 4)Get the final result, Z axis angular rate: 0.03°/s; Y axis acceleration data: -0.003g data; Z axis angle: 22.26°.

3. Setting sensor azimuth ZERO

Modbus function code 06H

Set Relative/Absolute ZERO Command :		Slave response :	
Sensor add	01H	Sensor add	01H
Function code	06H	Function code	06H
Access register first address	00H	Register address	00H
	10H		10H
If the word is nonzero, it is zero azimuth	00 H	If the word is nonzero, it is zero azimuth	00H
	FFH		FFH
CRC	C84FH	CRC	C84FH

Set ZERO command example :									
Master send			01 H	06 H	00 H	10 H	00 H	FFH	C8H 4FH
Slave response									
01 H	06 H	00 H	10 H	00 H	FFH	C8 H	4FH		

Note: 0010 is a register address, and 00FFH is written to this register. (as the above example, written in 00FFH), the current azimuth is cleared to zero. The last two bytes are CRC check sums

4. Set sensor address :

Set sensor address code command :		Slave response :	
Sensor add	01H	Sensor add	01H
Function code	06H	Function code	06H
Address	00H	Register address	00H
	11H		11H
Sensor new address 04H	00 H	Sensor new address	00 H
	04H		04H
CRC	D80C	CRC	D80C

Commands must be sent two times continuously to be valid

Set sensor address command example :								
Master send			01 H	06 H	00 H	11 H	00 H	04H D8H 0CH
Slave response								
01 H	06 H	00 H	11 H	00 H	04H	D8 H	0CH	

Note: 0011H is a register address, which controls the address of the sensor. In the above example, the address of the sensor is changed to 0004H, and the last two bytes is CRC check sum.

5. Set sensor baudrate command : (default 9600bps)

Set sensor address code command :		Slave response :	
Sensor add	01H	Sensor add	01H
Function code	06H	Function code	06H
Address	00H	Register address	00H
	12H		12H
Sensor baudrate	00 H	Sensor baudrate	00 H
	A2		A2
CRC	A876	CRC	A876

XX : A1H:9600 A2H:19200 A3H:38400 A4H:115200

Commands must be sent two times continuously to be valid

Set sensor address command example :								
Master send			01 H	06 H	00 H	12 H	00 H	A2H A8H 76H
Slave response								
01 H	06 H	00 H	12 H	00 H	A2H	A8 H	76H	

Note: 0012H is a register address, which controls the baud rate of the sensor. In the above example, the baud rate of the sensor is set to 19200, and the last two bytes is CRC check sum.

2-6.Set sensor auto output : (factory default is 0HZ , query mode)

Set sensor address code command :		Slave response :	
Sensor add	01H	Sensor add	01H
Function code	06H	Function code	06H
Address	00H	Register address	00H
	13H		13H
Sensor output frequency	00 H	Sensor baudrate	00H
	00H		00H
CRC	780FH	CRC	780FH

XX: 00 : Query mode ;

01 : 5HZ;

02 : 15HZ;

03 : 25HZ;

04 : 35HZ;

05 : 50HZ;

06 : 100HZ

Set sensor address command example :									
Master send		01 H	06 H	00 H	13 H	00 H	00H	78H	0FH
Slave response									
01 H	06 H	00 H	13 H	00 H	00H	78H	0FH		

Set sensor query mode .

Note: To update the baud rate, output mode (automatic output frequency or query) and address and other parameters, please re-power on the sensor.



Add : Building 1, COFCO (Fu'an) Robot Intelligent Manufacturing Industrial Park,

No. 90 Dayang Road, Fuhai Street, Bao'an District, Shenzhen, China

Tel : (86) 755-29657137 (86) 755-29761269

Fax : (86) 755-29123494