

Coating Thickness Gauge Instruction Manual

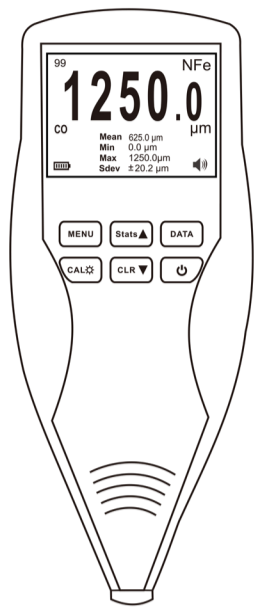

-1-

This handheld thickness gauge with separate probe is a highly intelligent and precise instrument used to quickly and accurately measure thickness of coating or plating on almost all kinds of metal surface. It not only indicates thickness of coating or plating but also automatically identifies the base material (Fe means magnetic metals such as iron & steel; NFe means non-magnetic metals, such as aluminum, alloy & non-magnetic stainless steel). It is applicable to measure various coating or plating, including non-magnetic painting, ceramic, enamel, plastic, rubber coating on magnetic base materials such as iron and steel, non-ferrous metal plating such as nickel & chromium, anticorrosive coating in chemical and petroleum industry, non-conductive painting, plastic coating and anodic oxide film on non-magnetic conductive devices, such as on aircraft or spacecraft, vehicle, home appliances, al-alloy door & window as well as other aluminum ware, and conductive coating or plating as long as the conductivity of coating or plating is at least 3 times less than that of base materials (such as copper with chromium plating).

Specification:

Measuring Range: 0-1250 μ m/ 0-50mil
 Resolution: 0.1 μ m / 0.1mil
 Accuracy: $\pm(2\%+2\mu\text{m}) / \pm(2\%+0.1\text{mil})$
 Product Size: 166 x 68 x 30mm 6.5x 2.5 x 1 inch
 Product Weight: 180g/ 0.4 lb(with batteries)
 Operation Temperature: -10 to +50 $^{\circ}$ C(+12 to +122 $^{\circ}$ F)
 Note: Only take measurement after the probe of the instrument reaches environment temperature. Please disregard the first several readings if you are not sure whether the probe is stable under current environment temperature.

Keypad Introduction :

Short press, switch on the instrument. Long press switch off the instrument. Instrument automatically switches off

-2-

Measuring Mode: The instrument has 2 measuring modes available, Single Measurement and Continuous Measurement. Long press , enter ROOT menu, "Options">"Mode", press to choose measuring mode

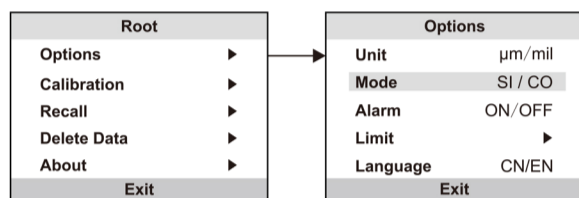

Single Measurement (SI): Press the probe vertically against the measured surface to take a measurement, the instrument will beep once and display the thickness value on the screen when reading is acquired. Wait at least 2 seconds to take another measurement. Note: Do not drag the probe on the measured surface. Refer to the below image for the display:

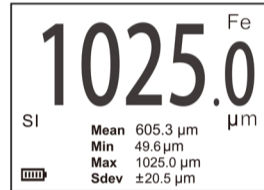

1025.0 μ m- the measuring value
 Mean 605.3 μ m – The average value of all the recorded data
 Min 49.6 μ m --- The minimum value of all the recorded data
 Max 1025.0 μ m---The maximum value of all the recorded data
 Sdev \pm 20.5 μ m— The standard deviation (2%+2 μ m)
 Fe --- The substrate material is magnetic ferrous like steel (NFe --- The substrate material is non-magnetic ferrous like Aluminum.)

Continuous Measurement (CO): Press the probe vertically

-5-

in case of no operation within 180 seconds.



(Menu/Back): Long press enter into main menu . Short press . Return to previous menu.

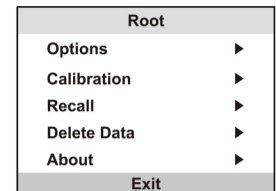

(Statistics/Up): Under measuring mode, short press , instrument displays the statistic data of Max /Min/Average Value. Refer to the below image:

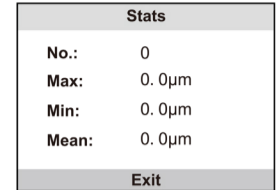

(Data/Enter): Under measuring mode, short press instrument displays the recorded data. Refer to the below image :

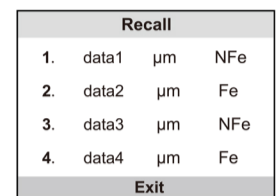

-3-

against the measured surface to take a measurement, the instrument will beep continuously and display the thickness value on the screen when reading is acquired. Note: Do not lift the probe up from the measured surface until the measurement is finished. Refer to the below image for the display:

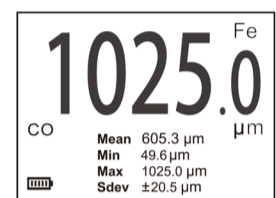

Measure Range: The instrument is used to measure thickness of coating or plating from 0 μ m to 1250 μ m. In case of thickness beyond this range, "---" will appear on the screen . Refer to the below image:

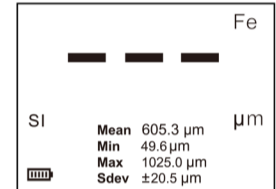

Battery Indication: The instrument is powered by four AAA batteries. Icon in green color means full battery, after using for a period of time, the green bar becomes shorter indicating the current capacity of the batteries. When icon appears in red and blinks, the batteries are low. Note: Please recharge or replace the batteries in this case .otherwise it may affect measurement accuracy.

Unit of Measurement:

-6-

(Calibration/Backlight): Under measuring mode, Long press , switch on the backlight, press or to adjust the brightness .

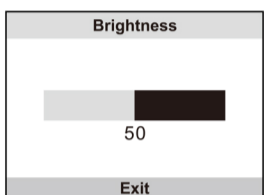

Short press , go to the calibration page. Refer to the below image:

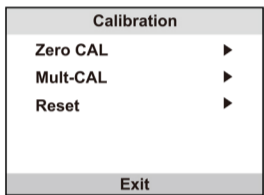

(Delete/Down) : Under measuring mode, short press , to delete a recorded data .

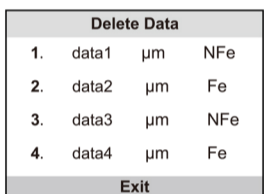

Operation:
 Switch On : Short press , the instrument switched on with a beep and the model No.

-4-

Long Press , enter main menu, "Root"->"Options"->"Unit". Press to choose between μ m and mil

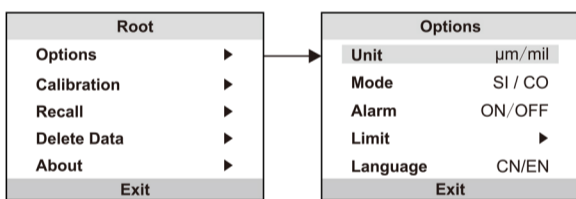

Language:
 Long Press , enter main menu, "Root"->"Options"->"Language". Press to choose between English (EN) and Chinese (CN)

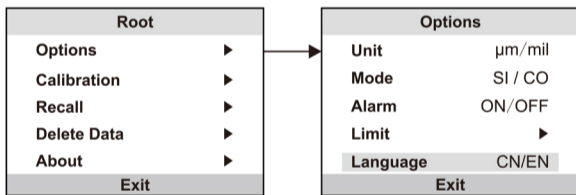

Alarm Function
 Alarm Range setting : Long Press , enter main menu, "Root"->"Options"->"Limit", User can set the upper range and lower range for alarm . Press or (long press fast adjustment) to adjust the range .

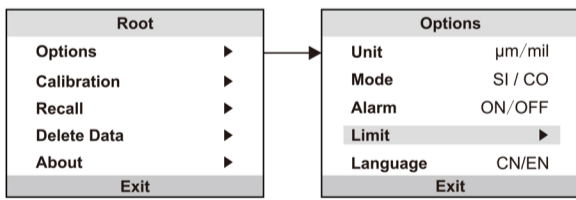

-7-

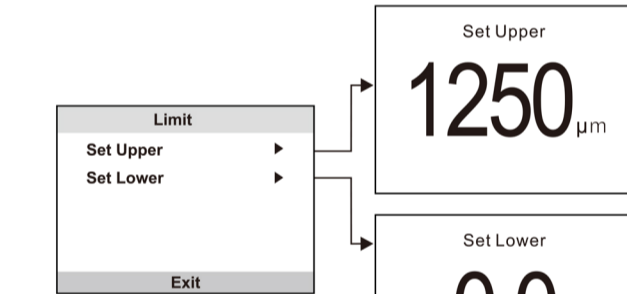

Switch on/ off the Alarm: Long Press , enter main menu, "Root"->"Options"->"Alarm", Press to switch on or off the Alarm . When the alarm is switched on, the instrument displays as below image:

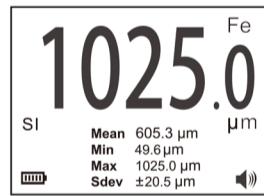

When the measurement is out of the range of the alarm setting , the instrument sounds 3 beeps as indication

View and Clear the Recorded Data
 View the recorded data: Short press to view the recorded data, press and to view all the last 50 data.

-8-

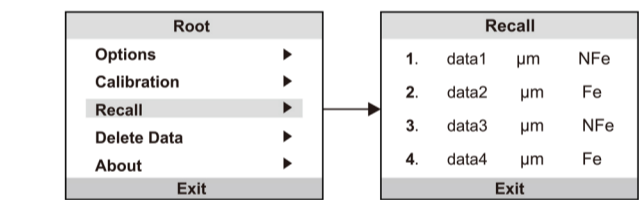

Data Delete: Long press , "Root"->"Delete Data", press choose to delete a single data or clear all the data

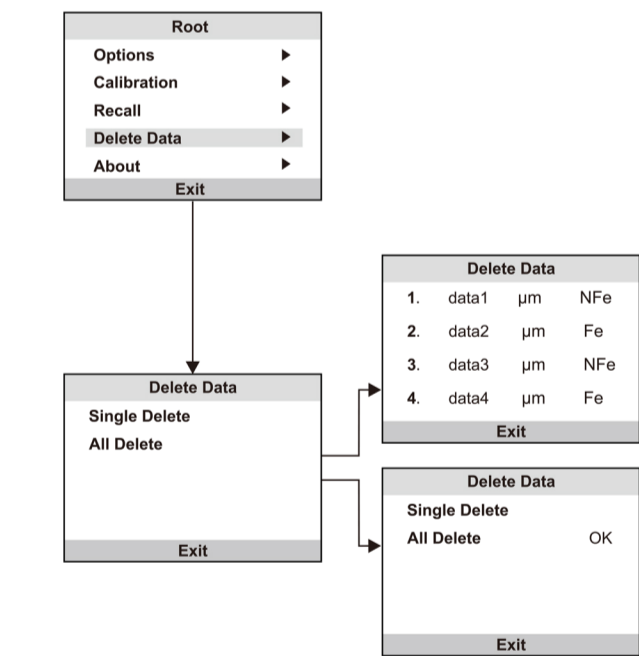

Standard Plastic Films & Calibration

-9-

Initialization:
 In case zero-in or calibration with standard plastic films does not work , please reinitialize the instrument : short press , choose "Rest", choose "All Reset", short press , "All Reset-OK" will blink and beep will sound indicating initialization is completed . To ensure high measurement accuracy, it is suggested to do Zero-In after initialization. All previously saved values and settings will be cleared after initialization. the instrument reset to factory default setting .

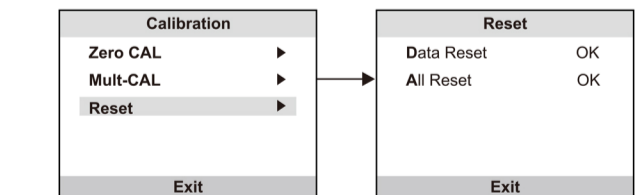

Notes:
 When measure the coating thickness on alloy material like aluminum alloy and stainless steel , the equipment has to be calibrated in the following way :
 1, Switch the device on , initialize it to factory default setting , switch off the device .
 2, Switch the device on again , calibrate it on the 6 standard films (Incase the accuracy been affected , keep the equipment away from any metal during the whole calibration)

Accuracy Checking
 The user may check the accuracy of the instrument according to given reference standards (The instrument is provided with standard plastic films which can be used to check the measurement accuracy, and to cover rough or hot surface during measurement to protect the sensor of the instrument from possible damage.), using the standard plastic films and substrate blocks supplied in the package .
 The measured value should be within the accuracy range specified in the user's manual. For example , if the accuracy specified as $\pm (2\%+2\mu\text{m})$, the reading should be 47-53 μ m when it's used to measure the standard plastic film with 50 μ m thickness . Otherwise, the instrument should be calibrated.

Calibration
 The instrument has been carefully factory calibrated and the built-in self-check functions every time before measurement. Therefore in most cases, the only thing needed to do is to check whether the reading is zero when tacking a measurement on uncoated metal. If not, Zero-in procedure is suggested.

Zero CAL: Short press , choose "Zero CAL" , short press "000" will blink on screen , take a measurement on the uncoated substrate , it displays "0", and been calibrated to zero . After Zero-In , usually the instrument can be used to accurately measure thickness. however, due to abnormal base material or severe environment , accumulated error may occur , in this case , you can use standard plastic films to do the multi point calibration for the instrument .

Mult-CAL: Use the instrument to measure the standard plastic film on a substrate block, in case the measured value is beyond the accuracy range as specified in the user's manual. Lift the probe up, "Pt1 ~ μ m " blinks on the screen , press or (long press keys for fast adjustment) to adjust the value to the

-10-

actual thickness .repeat the operation to do the calibration on the other plastic films too .
 Two standard plastic films can be used for better calibration, i.e., to do calibration with a thin film and a thick film alternatively. In case the coatings or plating to be measured are relatively close to each other in thickness, it is enough to use only one standard plastic film with similar thickness to do the calibration.

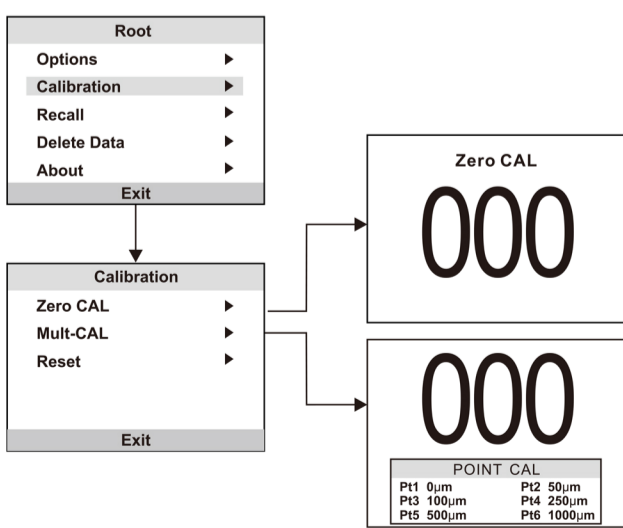

-11-

-12-