

FT0206 Wireless Rain Gauge with Temperature and Humidity User Manual

1. Getting Started

1.1 Insert batteries into the rain gauge transmitter. Rotate and detach the upside bucket, arrow direction as show in figure 1.

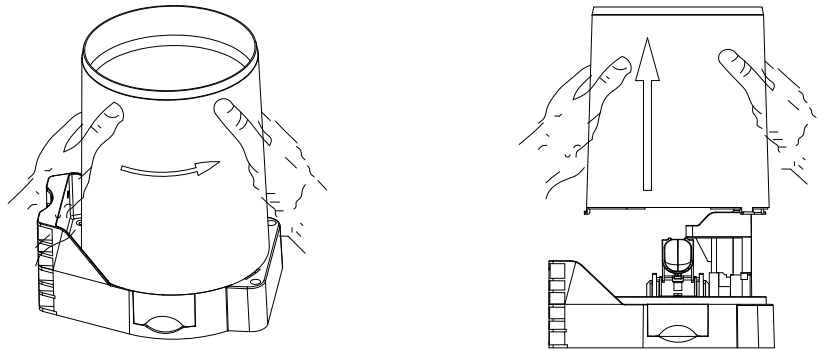

Figure 1

Locate the battery door on the rain gauge transmitter, pull out the battery compartment, as show in Figure 2.

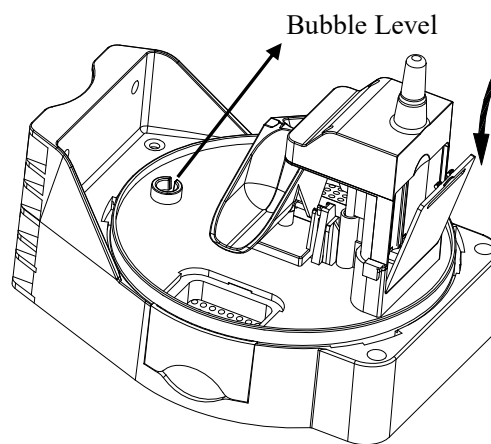

Figure 2

Inserting 4xAAA batteries in the battery compartment, as show in Figure 3.

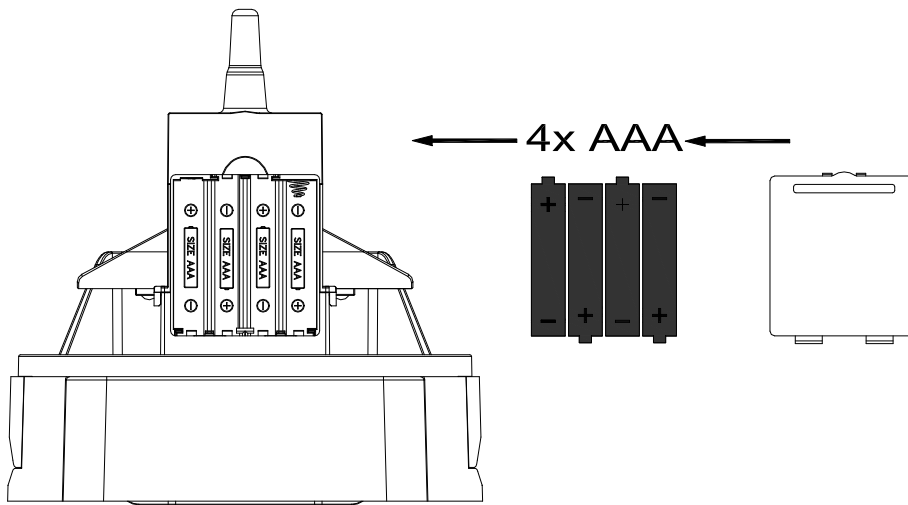

Figure 3

The Rain gauge sensor LED indicator will light for 3 seconds, and then flash once per 60 seconds thereafter. Each time it flashes, the sensor is transmitting data.

Close the battery door and tighten it.

1.2 Insert batteries into the thermo-hygrometer transmitter.

Pull down on the battery door to open the battery compartment, as shown in Figure 4. Insert two fresh AAA batteries (with the negative terminal of the battery in contact with each spring). Lithium batteries are recommended for cold weather environments. Slide the top lip of the battery door into the battery compartment guide. as shown in Figure 7. as shown in Figure 4.



Figure 4

BEFORE inserting the batteries, locate the dip switches on the inside cover of the lid of the transmitter.

displays all four switches in the OFF position (factory default setting), as shown in Figure 5.



Figure 5

1. **Channel Number:** The FT0206 supports up to eight transmitters. To set each channel number (the default is Channel 1), change Dip Switches 1, 2 and 3, as referenced in Table 1.
2. **Temperature Units of Measure:** To change the transmitter display units of measure (°F vs. °C), change Dip Switch 4, as referenced in Table 1.

DIP SWITCH				FUNCTION
1	2	3	4	
DOWN	DOWN	DOWN	---	Channel 1
DOWN	DOWN	UP	---	Channel 2
DOWN	UP	DOWN	---	Channel 3
DOWN	UP	UP	---	Channel 4
UP	DOWN	DOWN	---	Channel 5
UP	DOWN	UP	---	Channel 6
UP	UP	DOWN	---	Channel 7

UP	UP	UP	---	Channel 8
---	---	---	DOWN	°F
---	---	---	UP	°C

Table 1

- 1) Insert two AAA batteries.
- 2) After inserting the batteries, the remote sensor LED indicator will light for 4 seconds, and then flash once per 60 seconds thereafter. Each time it flashes, the sensor is transmitting data.
- 3) Verify the correct channel number (CH) and temperature units of measure (°F vs. °C) are on the display, as shown in Figure 6.

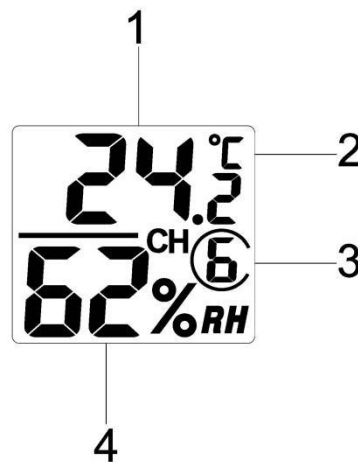



Figure 6

- (1) temperature
 - (2) temperature units (°F vs. °C)
 - (3) channel number
 - (4) relative humidity
- 4) Close the battery door. Make sure the gasket (around the battery compartment) is properly seated in its trace prior to closing the door. Tighten the set screw.

1.3 Insert Batteries into Display Console

The display console layout is shown in Figure 7

 **Note:** The following illustration shows the full segment LCD display for description purposes only and will not appear like this during normal operation.

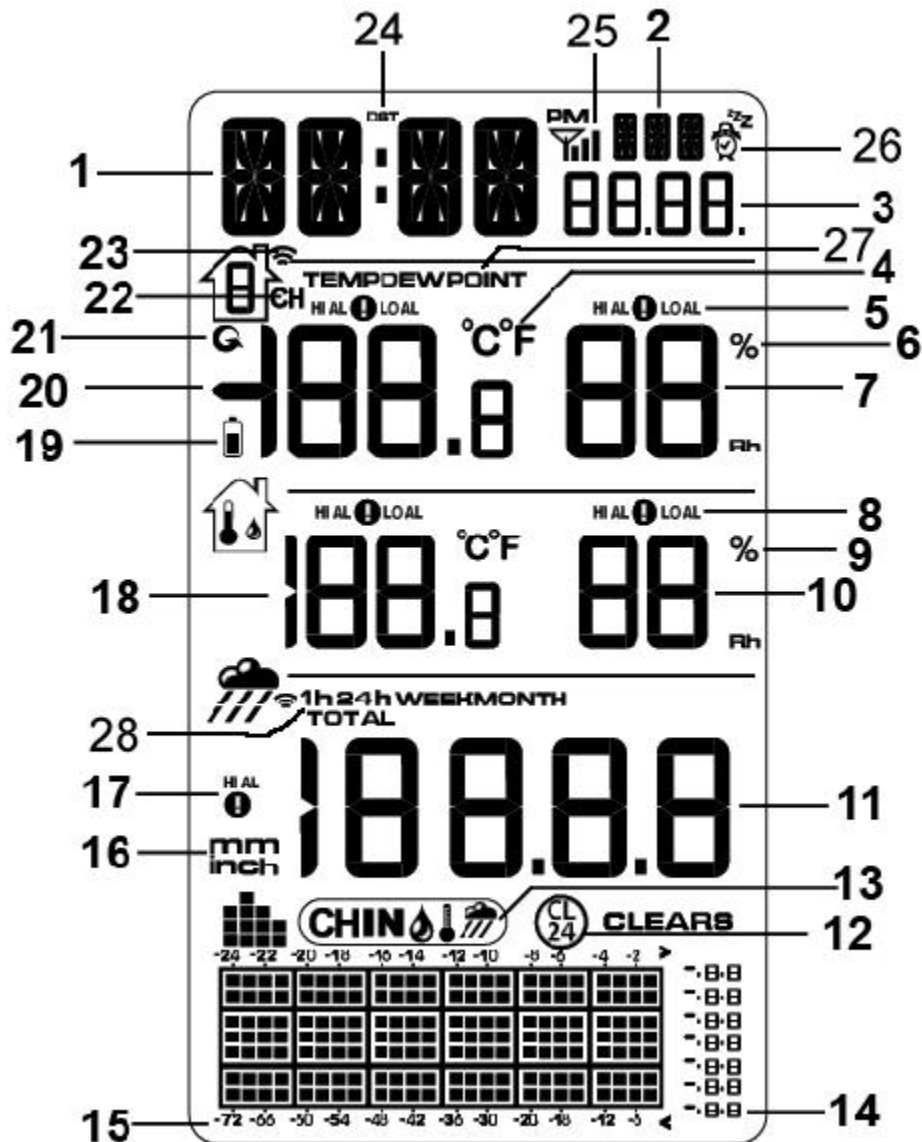

Figure 7

- | | |
|--|---|
| 1. Time | 14. Temperature, humidity and rainfall in past 24h or 72h |
| 2. Week | 15. Time format of history graph (24h or 72h) |
| 3. Date | 16. Rainfall units of measure |
| 4. Temperature units (°F or °C) | 17. Rainfall HI alarm icon |
| 5. Outdoor temperature and humidity HI/LO alarm icon | 18. Indoor temperature display |
| 6. Outdoor Humidity unit (percentage) | 19. Low power indicator |
| 7. Outdoor humidity display | 20. outdoor temperature display |
| 8. Indoor temperature and humidity HI/LO alarm icon | 21. Scroll mode indicator |
| 9. Indoor Humidity unit (percentage) | 22. Channel 1,2,3,4,5,6,7,8 indicator |
| | 23. Signal search icon |

- 10. Indoor humidity display
- 11. Rainfall display
- 12. Min/Max reset for 24h
- 13. Temperature, humidity and rainfall history display icon
- 24. Daylight Saving Time
- 25. RCC search icon
- 26. SNOOZE Flashing Time sleep
- 27. Temperature and Dew point
- 28. Rain time display (1h, 24h, week, month, total)

Remove the battery door on the back of the display, as shown in 8. Insert four AAA (alkaline or lithium)) batteries in the back of the display console. The display will beep once and all of the LCD segments will light up for a few seconds to verify all segments are operating properly.

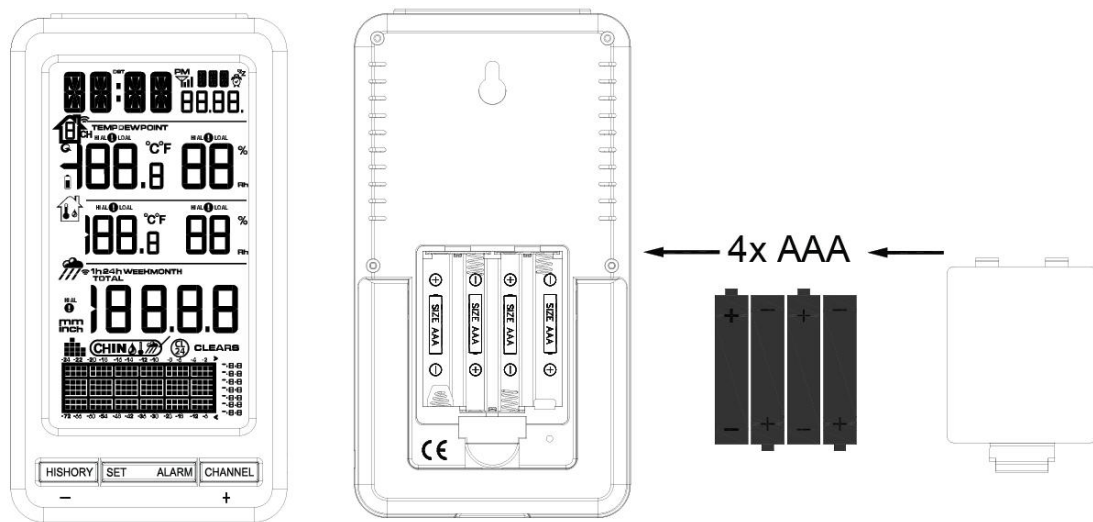



Figure 8

Replace the battery door, and fold out the desk stand and place the console in the upright position.

The unit will instantly display indoor temperature, humidity, and time. The rain, outdoor temperature and humidity will update on the display within a few minutes. Do not Press any menu buttons until the outside transmitter report in, otherwise the outdoor sensor search mode will be terminated. When the outdoor transmitter data has been received, the console will automatically switch to the normal mode from which all further settings can be performed.

While in the search mode, the remote search icon  will be constantly displayed.

If you have more than one thermo-hygrometer sensor (up to eight thermo-hygrometer sensors are supported), the display will automatically toggle between sensors until all sensors have reported in.

 **Note:** You can connect with any standard 5V power adaptor as power source.

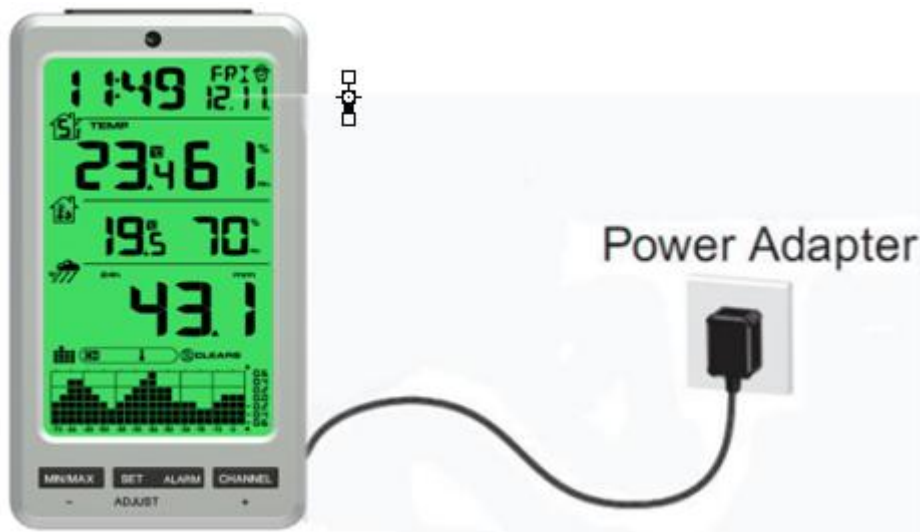



Figure 9

 **Note:** If the power adapter is plugged in, **AC ON** will display in the time area for three seconds when powered up. Conversely, if the power adapter is not plugged in, **AC OFF** will be displayed.

2. Weather Station Installation

2.1 Rain Gauge Transmitter Installation. Remove the rain gauge funnel from the base prior to installation by rotating the counter clockwise until the tabs on the base and the funnel align, then pulling upwards.

Fasten the rain gauge to the mounting pole, as shown in Figure 10.

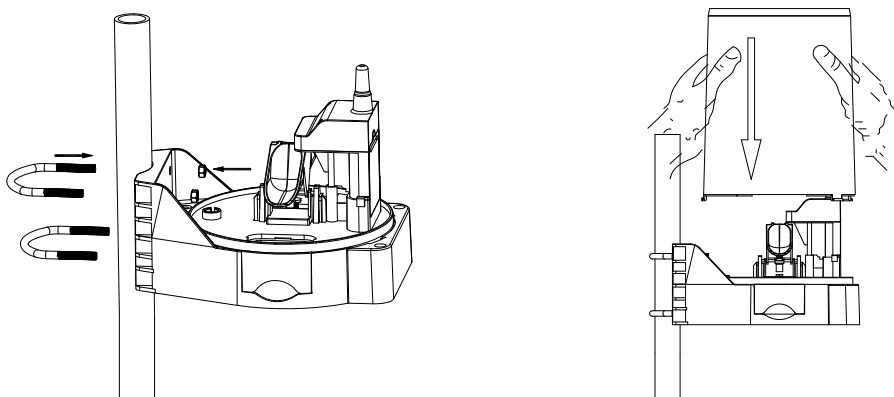

Tighten the rain gauge to your mounting pole or bracket with two U-bolts and four M5 nuts, or fix on a horizontal surface with the four tapping screws.

Reattach the funnel by aligning the tabs on the funnel and base, and rotate clockwise. Put the filter net into the top hole to clear the debris, as shown in Figure 11.

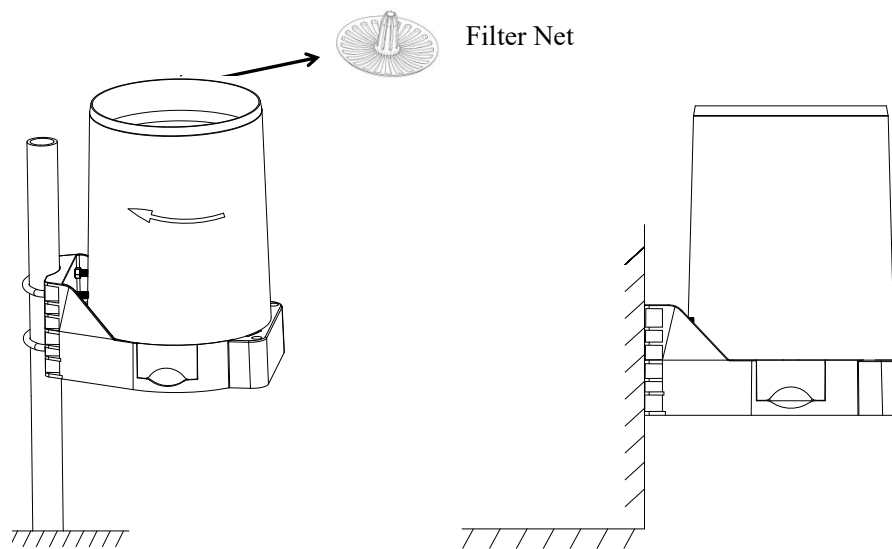

Figure 11

2.2 Thermo-hygrometer Transmitter installation. It is recommended you mount the Thermo-hygrometer sensor outside in a shaded area. A north facing wall is preferred because it is in the shade most of the day. Direct sunlight and radiant heat sources will result in inaccurate temperature readings. Although the sensor is water resistant, it is best to mount in a well protected area, such as under an eave. Use a screw or nail (not included) to affix the remote sensor to the wall, as shown in Figure 12.

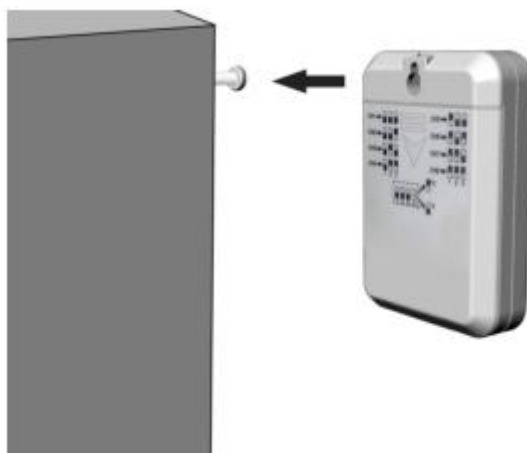



Figure 12

3 Low Battery Icon

A low battery indicator icon is shown in the display window for thermo-hygrometer sensor. When the low battery icon appears (the battery voltage is lower than 2.4V), replace the batteries in the sensor with fresh batteries. Be sure to never mix old and new batteries, and never mix battery types such as alkaline and lithium together.

4 Console Operation

 **Note:** The console has five keys for easy operation: **HISTORY** key, **SET** key, **ALARM** key, **CHANNEL (+)** and **SNOOZE/LIGHT** key.

4.1 Quick Display Mode

 **Note:** To exit the Quick Display Mode at any time, press the **LIGHT** button on the top of the display console.

While in Normal Mode, press (do not hold) the **SET** key to enter the Quick Display Mode as follows:

- Once for time, time/week and date,

- Twice for rainfall.
 - Three times for 72h or 24h graph record
1. **Time, Time/Week and Date.** Press the **CHANNEL** or **HISTORY** key to toggle between time, time/week and date.
 2. **Rainfall.** Press the **CHANNEL/+** or **HISTORY/-** key to toggle between 1h, 24h, week, month and total.
 3. **72h or 24h Graph Record.** Press the **CHANNEL** or **HISTORY** key to toggle between the last -72 hours or -24 hours record time. Each bar represents the corresponding data and time for rainfall, temperature or humidity.(default is -72 hours), as shown in Figure 13

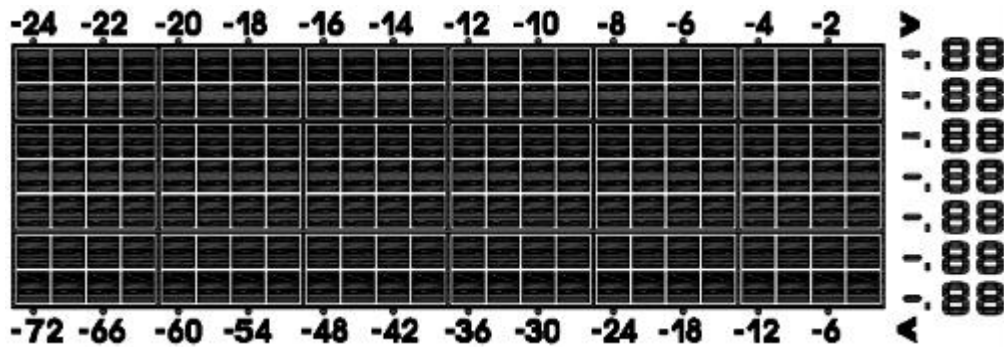





Figure 13

 **Note:** The graph displays hours on the horizontal or x-axis (the most recent data to the right of the graph). For example, 0h is the current data and -12 is 12 hours ago. The vertical axis or y-axis auto-scales, displays the deviation from the current value (the most recent data will always display 0). For example, when in temperature mode, if the bar displays 0.4, this represents 0.4 degrees higher than the current value.

4.2 Set (Program) Mode

While in Normal Mode, **press and hold** the **SET** key for at least three seconds to enter the Set Mode. The first setting will begin flashing. You can press the **SET** key again to skip any step, as defined below.

 **Note:** In the Set mode, press the **[+]** key or **[-]** key to change or scroll the value. Hold the **[+]** key or **[-]** key for three seconds to increase/decrease rapidly.

 **Note:** To exit the Set mode at any time, press the **LIGHT** button on the top of the display console.

1. **12/24 Hour Format (default: 24h):** Press the **SET** key again to adjust the 12 / 24 hours format setting (FMT). Press the [+] key or [-] key to change between 12 hour and 24 hours format.
2. **Change Hour.** Press the **SET** key again to set the hour. Press the [+] key or [-] key to adjust the hour up or down.
3. **Change Minute.** Press the **SET** key again to set the minute. Press the [+] key or [-] key to adjust the minute up or down.
4. **Date Format (default: DD-MM):** Press the **SET** key again to enter the day/month format mode. Press the [+] key to switch between MM-DD-YY, DD-MM-YY.
5. **Change Month.** Press the **SET** key again to set the calendar month. Press the [+] key or [-] key to adjust the calendar month.
6. **Change Day.** Press the **SET** key again to set the calendar day. Press the [+] key or [-] key to adjust the calendar day.
7. **Change Year.** Press the **SET** key again to set the calendar year. Press the [+] key or [-] key to adjust the calendar year.
8. **Max/Min Clearing (default: ON).** Press the **SET** key again to set the max/min clearing mode (CLR). The Max/Min can be programmed to clear daily (at midnight) or manually. Press the [+] key or [-] key to switch between “Clears 24h” and Clears Manually.
9. **Temperature Units of Measure (default: °C):** Press the **SET** key again to change the temperature units of measure (the **UNITSET** icon will be displayed). Press the [+] key or [-] key to switch between °F and °C units of measure.
10. **Rainfall Units of Measure (default: mm).** Press the **SET** key again to change the Rainfall units of measure. Press [+] key or [-] key to toggle the rainfall units between mm and inch.
- 11.

 **Note:** Press the **HISTORY/-** key and install the battery simultaneously, the **RESET** will display and restore to factory default settings.

4.3 Channel Selection

Press the **CHANNEL/+** button to switch the display between remote thermo-hygrometer sensors 1 through 8, and scroll mode . In scroll mode, all of the indoor and detected outdoor thermo-hygrometer sensors will be displayed in five second intervals.





4.4 Sensor Search Mode

If any of the sensor communication is lost, dashes (--.) will be displayed on the screen. To reacquire the signal:

Press and hold the **CH/+** button for 3 seconds to enter sensor search mode, press **[+]** key or **[-]** key to toggle between **CH (1 - 8)**, **RAIN** and **ALL** .

1. If a specific channel is lost, press the **CH/+** button to display this channel, in search mode to select **CH(1-8)** and press SET key to exit, the search icon will be displayed constantly for 3 minutes. Once the signal is reacquired, the remote search icon  will turn off, and the current values will be displayed.

 Note: In search mode, the **CH (1-8)** will display the current specific channel.

2. If rain sensor channels are lost, in search mode to select **RAIN** and press SET key to exit, and the remote search icon  will be constantly displayed for up to 3 minutes. Once the signal is reacquired, the remote search icon  will turn off, and the current values will be displayed.
3. If new sensors are added, subtracted, or multiple sensor channels are lost, in search mode to select **ALL** and press SET key to exit, and the remote search icon  will be constantly displayed for up to 10 minutes. Once the signal is reacquired, the remote search icon  will turn off, and the current values will be displayed.

4.5 History Graph Mode

The historical graph on the display changed to display the measured parameters.

In normal mode, press the **HISTORY/-** key to toggle between:

- the rainfall graph (the **RAIN** icon is displayed)
- indoor temperature graph (the **TEMP-IN** icon is displayed)
- indoor humidity graph (the **HUMI-IN** icon is displayed)
- outdoor temperature graph (the **TEMPOUT** icon is displayed)
- outdoor humidity graph (the **HUMIOUT** icon is displayed)

 Note: The outdoor humidity and temperature graph will display history graph of current channel.

4.6 Reset Min/Max record

 Note: If you own more than one thermo-hygrometer sensor, the minimum and maximum value of all channels will be cleaned in cleaning mode.

In normal mode, press (do not hold) the **ALARM** key, the **MAX** icon will be displayed. Press the **HISTORY/-** key to view rainfall (1h, 24h, week or month) max value.

Next, press the **SET** key for three seconds to clear the maximum values of rainfall, dew point, temperature and humidity. The maximum values will now display the current values.

Press the **ALARM** key again (do not hold), the **MIN** icon will be displayed. Press the **HISTORY/-** key to view dew point or temp min value.

Next, press the **SET** key for three seconds to clear the minimum values of dew point and temperature and humidity. The minimum values will now display the current values.

Press the **LIGHT** key to exit the min/max checking and cleaning mode, return to normal display mode.

4.7 Back light Mode

If the LED is off, press the **LIGHT** button once. The backlight will turn on for five seconds, and if no operation is performed for three seconds, the backlight will turn off.

Press and hold the **LIGHT** key for two seconds, and the backlight will turn on permanently, and display **LED ON** icon will be displayed for three seconds in the time field.

IF the LED is on, press and hold the **LIGHT** button once, and the LED will turn off.

 **Note:** If plugged into AC power, the time area will display **AC ON** and the backlight will remain on. It is not recommended leaving the backlight on for a long period of time when operating on batteries only, or the batteries will run down quickly.

5 Alarm Mode

The FT0206 includes time alarm, temperature alarm and humidity alarm features for indoor and Channel 1 and dew point alarm for Channel 1, rainfall (1h and 24h) alarm.

5.1 Alarm Operation

When an alarm condition is exceeded, the alarm icon will flash  (visual) and the alarm beeper will sound (audible). To silence the beeper, press any key. The alarm beeper can be permanently silenced by referencing Section 5.4.

5.2 Viewing the High and Low Alarms

Time of day, indoor, channel 1, rainfall (1h and 24h) alarms are supported. Channels 2-8 alarms are not supported.

To view the current alarm settings, press and hold the **ALARM** key for three seconds to enter the alarm mode.

Next, press the **ALARM** key to view the HI and LOW alarm along with the alarm time. Press the **SET** key to view rainfall (1h and 24h) high alarm.

Press the **LIGHT** key at any time to return to the normal mode

5.3 Setting the Alarms

In alarm mode, press and hold the **SET** key for three seconds. The alarm parameter will begin flashing. To adjust the alarm parameter, press the [+] or [-] key to increase or decrease the alarm setting slowly, or press and hold the [+] or [-] key for three seconds to increase or decrease the alarm setting rapidly.

Press the **ALARM** key to turn on (the alarm icon will appear ) and off the alarm.

To save the alarm setting and proceed to the next alarm parameter, press (do not hold) the **SET** key.

Press the **LIGHT** key twice at any time to return to the normal mode. After 30 seconds of inactivity, the alarm mode will time out and return to normal mode.

The following is a list of the individual alarm parameters that are set (in order):

1. Alarm hour
2. Alarm minute
3. Outdoor (channel 1) temperature high alarm
4. Outdoor (channel 1) temperature low alarm
5. Outdoor (channel 1) humidity high alarm
6. Outdoor (channel 1) humidity low alarm
7. Outdoor (channel 1) dew point high alarm
8. Outdoor (channel 1) dew point low alarm
9. Indoor temperature high alarm

10. Indoor temperature low alarm
11. Indoor humidity high alarm
12. Indoor humidity low alarm
13. Rainfall (1h) high alarm
14. Rainfall (24h) high alarm

5.4 Alarm and Command Key Beeper ON/OFF Mode

The beeper can be silenced for both alarms and key strokes.

In normal mode, press and hold the **HISTORY**/- key for three seconds to toggle the beeper on or off (depending on the current setting).

The **BUZZON** (beeper on) or **BUZZOFF** (beeper off) icon will appear in the time area for three seconds. Press and hold the **HISTORY**/- key again for three seconds to toggle the **BUZZON** or **BUZZOFF** command.

6. Specifications

6.1 Wireless Specifications

- Line of sight wireless transmission (in open air): 100m.
- Frequency: 433 MHz
- Update Rate: 60 seconds for rain sensor and thermo-hygrometer sensor.

6.2 Measurement Specifications

The following table provides specifications for the measured parameters.

Measurement	Range	Accuracy	Resolution
Indoor Temperature	0 to 60 °C	± 1 °C	0.1 °C
Outdoor Temperature	-40 to 60 °C	± 1 °C	0.1 °C
Indoor Humidity	10 to 99 %	± 5% (only guaranteed between 20 to 90%)	1 %
Outdoor Humidity	10 to 99%	± 5% (only guaranteed between 20 to 90%)	1 %

Rain	0 to 9999mm	<15mm: ± 1 mm, 15mm to 9999mm: $\pm 7\%$	<1000mm (0.3mm) >1000mm (1mm)
------	-------------	---	----------------------------------

6.3 Power Consumption

- Base station (display console): 4 x AAA 1.5V Alkaline or Lithium batteries (not included)
- Adaptor: 5V~ 500mA
- Thermo-hygro Sensor: 2 x AAA alkaline batteries or Lithium batteries (not included)
- Rain sensor: 4xAAA alkaline batteries or Lithium batteries (not included)

Battery life: Minimum 12 months for base station with excellent reception. Intermittent reception and multiple sensors may reduce the battery life.

Minimum 12 months for sensors (use lithium batteries in cold weather climates less than -20 °C)