

# 1 Introduction

This multifunction process calibrator (the calibrator in the following) is a handheld, battery-operated instrument that measures and sources electrical and physical parameters. (See Table 1)

Table 1 Source and Measurement Function

Measurement Function Sourcing Function		DCV	DCI		OHM	FREQ	TC	RTD	PRESSURE	SWITCH	CONT.
			LOOP OFF	LOOP ON							
DCV		●	●	●	●	●	●	●	●	●	●
DCI	RAMP ON	×	×	×	×	×	×	×	×	×	×
	RAMP OFF	●	●	●	●	●	●	●	●	●	●
OHM		●	●	●	●	●	●	●	●	●	●
FREQ		●	●	●	●	×	●	●	×	●	●
PULSE		●	●	●	●	×	●	●	×	●	●
SWITCH		●	●	●	●	×	●	●	×	●	●
TC		●	●	●	●	●	×	×	●	●	●
RTD		●	●	●	●	●	×	×	●	●	●
PRESSURE		●	●	●	●	×	●	●	×	●	●

Note: ● indicating simultaneous use is allowed

× indicating simultaneous use is not allowed

Except the functions listed in Table 1, the calibrator has the following features as well:

- You can operate the measurement and source function simultaneously. The LCD screen is divided into two separate districts, whose upper part displays measurement information and lower part displays source information.
- TC measurement/source terminals and built-in lead connector of same temperature (RJ compensation with auto-reference joint point)
- Manual step source and auto -step and sweeping –step source
- Room temperature monitoring under any operation
- Measurement/source temperature monitoring function
- Measurement/source mA% display
- Measurement wave-filter function
- Measurement manual-holding function
- Pressure source auto-holding function

## 2 Contact Us

To purchase parts, obtain operation help or address of the vendor or service center nearest to you, please call us or visit our web (see the bottom page of the Manual).

### 3 Standard Accessories

Make sure that the package contains all the accessories listed below. And if you find they are damaged or any of them is missing, please contact the vendor from which you purchased the product as soon as possible. Refer to the replacing part list in 15.3 in the Manual if you want to order the replacing parts.

- Two pair of Industrial testing Lead (H000002-00)
- A pair of Testing Probe (H000000-00)
- A pair of Alligator clip (H010000-00)
- A quick reference guide
- A User's Manual
- One Fuse 50mA/250V
- One Fuse 100mA/250V

### 4 Safety Information



For the correct and safe use of the instrument, be sure to follow the cautionary notes stated in this manual whenever handling the instrument. The Company shall not be held liable for any damage resulting from use of the instrument in a manner other than prescribed in the cautionary notes.

A **⚠Warning** identifies conditions and actions that pose hazards to the user; a **Caution** identifies conditions and actions that may damage the meter or the equipment under test.

Refer to Table 2 for the explanation of the international electric symbols adopted by the calibrator or the user's

manual.

Table 2 Explanations of International Electrical Symbols

	EARTH GROUND		WARNING INFORMATION
---	--------------	---	------------------------

### Warning

To avoid possible electric shock or personal injury:

- Do not apply more than the rated voltage, as marked on the calibrator, between terminals or between any terminal and earth ground;
- Before use, verify the meter's operation by measuring a known voltage;
- Follow all equipment safety procedures;
- Do not connect the probe of the testing lead with any live power when the other end has been inserted into the current jack;
- Do not use the meter if it is damaged. Before using the meter, inspect the case. Look for cracks or missing plastic .Pay particular attention to the insulation surrounding the connectors;
- Select the proper function and range for the measurement;
- Make sure the battery door is closed and latched before operating the meter;
- Remove test leads from the meter before opening the battery door;
- Inspect the test leads for damaged insulation or exposed metal. Check test lead continuity. Replace damaged test leads before using the meter;
- When using the probes, keep fingers behind the finger guards on the probes;
- Connect the common test lead before connecting the live test lead. When disconnecting test leads,

disconnect the live test lead first;

- Do not use the meter if it operates abnormally. Protection may be impaired. When in doubt, have the meter inspect;
- Do not operate this instrument in areas where inflammable or explosive gases or vapor exists. It is extremely hazardous to use the instrument under such environments;
- Do not operate the meter around explosive gas, vapor, or dust;
- When use the pressure module, do make sure the process pressure line is shut off and depressurized before connecting or disconnecting the pressure module;
- Use only type 4 AAA batteries, properly installed in the meter case, to power the meter;
- Do disconnect the testing lead before shifting to different source or measurement functions;
- When servicing the meter, use only specified replacement parts.
- To avoid false reading, which could lead to possible electric shock or personal injury, replace the batteries as soon as the low battery indicator (  ) appears.

### **Caution**

To avoid possible damage to meter or to equipment under test:

- Disconnect the power and discharge all high-voltage capacitors before testing resistance or continuity.
- Use the proper jacks, functions, and ranges for the measurement or source operation.

## **5 Familiar With the Calibrator**

Figure 1 Entire Graph

## 5.1 Measurement/ Source Terminals

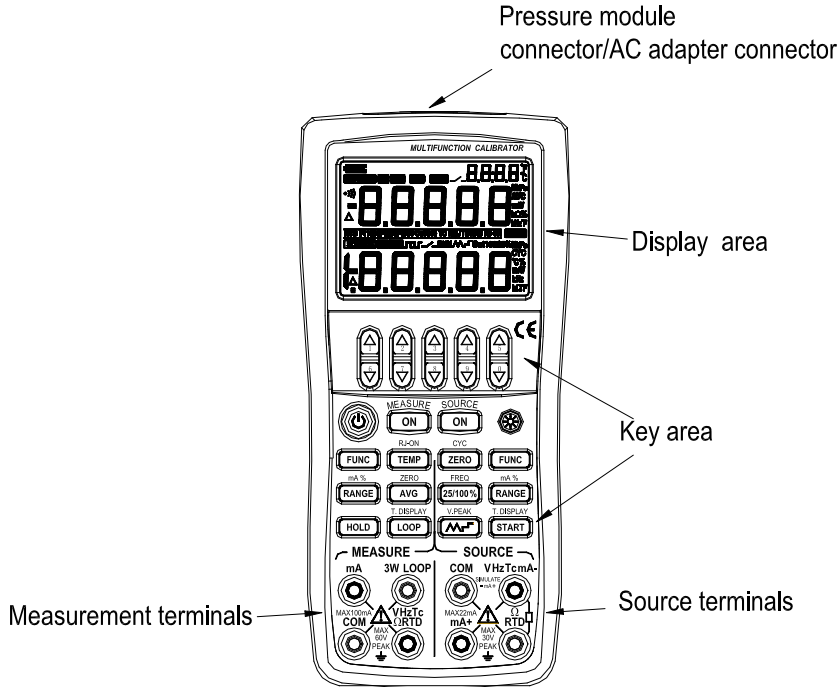

Figure 2 shows the measurement /source terminals of the calibrator. Table 3 explains their use.

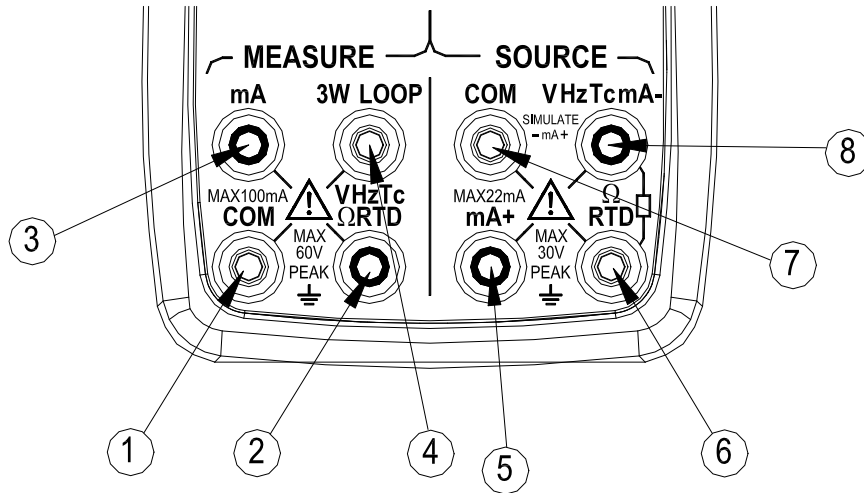

Figure 2 Measurement/ Source Terminals

Table 3 Measurement/ Source Terminals

Terminal	Function
①	All the common (return ) (-) terminals of measurement function
②	Measurement Signals (+) : DCV、OHM、FREQ、TC、RTD、SWITCH、CONT
③	Measurement Signals (+) : DCmA
④	3W Terminal: measurement terminal of the 3W OHM、RTD LOOP Terminal: +24VDC Loop Power Terminal
⑤	Source Signals: (+) DCmA
⑥	Source Signals: (-) OHM、RTD
⑦	All the common (return ) (-) terminals of source function
⑧	Source Signal: (+) DCV、OHM、TC、RTD、XMT、FREQ、CYC、SWITCH Source Signal: (-) DCmA

## 5.2 Keys



Figure 3 shows keys of the calibrator. Table 4 explains their use.

Figure 3 keys

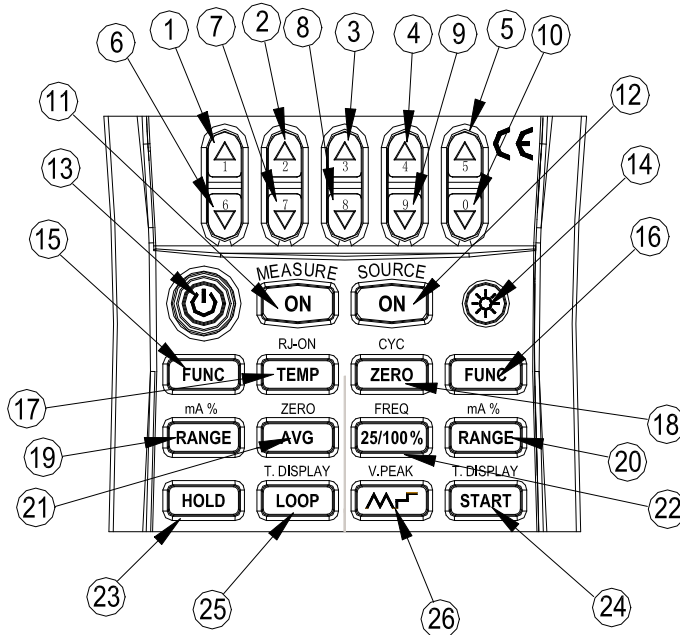



Table 4 Functions of the keys

No.	Name	Function
1~5	Source value set key	Increment of source set point
6~10	Source value set key	Decrement of source set point
11	Measurement <b>ON</b> key	Turn on or off measurement function
12	Source <b>ON</b> key	Turn on or off source function
13	Power key	Turn on or off the power
14	Backlight	Turn on or off the backlight
15	Measurement <b>FUNC</b> Key	Select measurement function
16	Source <b>FUNC</b> Key	Select source function
17	<b>TEMP</b> Key	Turn on or off room temperature monitoring function. In TC source or measurement function, turn on or off the RJ compensation function.
18	<b>ZERO</b> Key	Set the source value to zero-point. In pulse source function, set the pulse number.
19	Measurement <b>RANGE</b> Key	Select measurement range Measurement mA and percentage shifting.
20	Source <b>RANGE</b> Key	Select source range Source mA and percentage shifting.
21	<b>AVG</b> Key	Measuring average value Relative measured value of pressure

22	<b>25/100% key</b>	In mA source function, select 25% or 100% manual step output mode. In pulse number, frequency or switch source, set the frequency value.
23	<b>HOLD Key</b>	Measured value holding Source pressure and measure contact simultaneously, releasing the locked pressure reading.
24	<b>START Key</b>	Source auto-pulse number, turn on mA auto-stepping or sweeping function. Convert the sourced TC temperature and the mV, the sourced RTD temperature and the Ohm.
25	<b>LOOP Key</b>	24v Loop circuit power Convert the measured TC temperature and the mV, the measured RTD temperature and the Ohm.
26	 Key	In DCmA source function ,select the auto-wave mode. In frequency or pulse source, set the source amplitude.

## Display Screen

Figure 4 shows a typical display screen.

- a: Battery level indicator
- b: Measurement
- c: Measurement function on
- d: Measurement function off
- e: Average value for measurement
- f: Display –hold for measured value
- g: Switch measurement
- h: Zone of room temperature
- i: Beeper of measurement continuity
- j: Measured value
- k: Unit of measured value
- l: Divide line of measurement and source mode displays
- m: Types of RTD measurement / source
- n: Divide line of measurement and source mode displays
- o: Types of TC measurement / source
- p: Reference Junction Compensation On
- q: 24V Loop Power Supply on
- r: Source
- s: Source function on
- t: Source function off
- u: Set -point for source

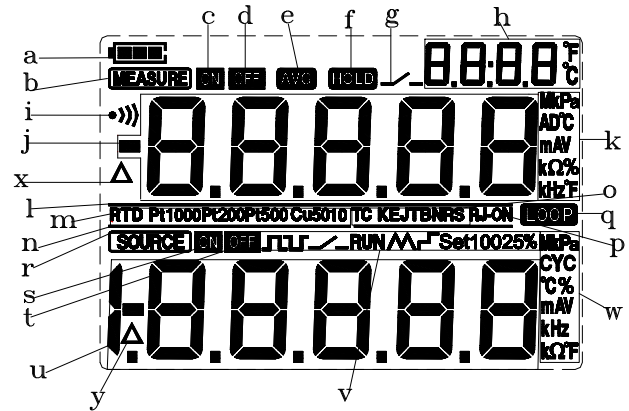

Figure 4 typical LCD display

- v: Set information for source
- w: Unit of set -point for source
- x: Measurement pressure reading zero off
- y: Source pressure reading zero off

## **6 Before starting source/measurement**

### **Operating Precautions**

#### **Precautions for Safe Use of the Instrument**

- When using the instrument for the first time, be sure to read the instructions given in Section Four “Precautions for Safe Use of the Instrument.”
- Do not open the instrument’s case.  
Contact the vendor from which you purchased the instrument, for a service of inspecting or adjusting the internal assembly.
- In case of failure  
Should the instrument begin to emit smoke, give off an unusual odor, or show any other anomaly, immediately turn off the POWER key. If you are using an Charger, disconnect the plug from the wall outlet. Also cut off power to the object under test that is connected to the input terminals. Then, contact the vendor from which you purchased the instrument.
- Charger  
Use an Charger dedicated to the instrument. Avoid placing any load on the Charger, or prevent any heat-emitting object from coming into contact with the adapter.

## General Handling Precautions

- Before carrying around the instrument turn off power to the object under test, and then the POWER key of the instrument. If you are using an Charger, disconnect the power cord from the wall outlet. Finally, detach all lead cables from the instrument. Use a dedicated carry case when transporting the instrument.
- Do not bring any electrified object close to the input terminals, since the internal circuit may be destroyed.
- Do not apply any volatile chemical to the instrument's case or operation panel. Do not leave the instrument in contact with any product made of rubber or vinyl for a prolonged period. Be careful not to let a soldering iron or any other heat-emitting object come into contact with the operation panel, as the panel is made of thermoplastic resin.
- Before cleaning the instrument's case or operation panel disconnect the power cord plug from the wall outlet if you are using an Charger. Use a soft, clean cloth soaked in water and tightly squeezed to gently wipe the outer surfaces of the instrument. Ingress of water into the instrument can result in malfunction.
- If you are using an Charger with the instrument and will not use the instrument for a prolonged period, disconnect the power cord plug from the wall outlet.
- For handling precautions regarding the batteries, see "Installing or Replacing the Batteries".
- Never use the instrument with the cover of the battery holder opened.

## Environmental Requirements

Use the instrument in locations that meet the following environmental requirements:

- Ambient temperature and humidity

Ambient temperature range: 0 to 50°C

Ambient humidity range: 20 to 80% RH. Use the instrument under non-condensing condition.

- Flat and level locations

**Do not use the instrument in locations that are**

- Exposed to direct sunlight or close to any heat source.
- Exposed to frequent mechanical vibration.
- Close to any noise source, such as high-voltage equipment or motive power sources.
- Close to any source of intensive electric or electromagnetic fields.
- Exposed to large amounts of greasy fumes, hot steam, dust or corrosive gases.
- Exposed to unstable or a risk of explosion due to the presence of flammable gases.

**Note:**

- Use the instrument under the following environmental conditions if precise source or measurement is your requirement:

Ambient temperature range:  $23 \pm 5^{\circ} \text{ C}$ ;

Ambient humidity range: 20 to 80% RH(non-condensing)

- When using the instrument within a temperature range of  $0$  to  $18^{\circ} \text{ C}$  or  $28$  to  $50^{\circ} \text{ C}$ , add a value based on the temperature coefficient shown in Chapter 18“Specifications” to the given accuracy rating.
- When using the instrument at an ambient humidity of 30% or lower, prevent electrostatic charges from being produced, by using an antistatic mat or any other alternative means.
- Condensation may occur if you relocate the instrument from places with low temperature and humidity to places with high temperature and humidity, or if the instrument experiences any sudden temperature change. In that case, leave the instrument under the given ambient temperature for at least one hour to ensure that the instrument is free from condensation, before using the instrument.

## Installing or Replacing the Batteries

### **⚠Warning**

To avoid electrical shock, always remove the source or measurement lead cables from the object under test, as well as from the instrument itself.

### **Caution**

- To avoid the risk of fluid leakage or battery explosion, install batteries with their positive and negative electrodes correctly positioned.
- Do not short-circuit the batteries.
- Do not disassemble or heat the batteries or throw them into fire.
- When replacing batteries, replace all of the four batteries at the same time with new ones from the same manufacturer.
- If the instrument will not be used for a prolonged period, remove the batteries from the instrument.

**Step 1:** Remove the lead cables and **charger** and turn off the calibrator before you begin installing batteries.

**Step 2:** Remove the battery holder cover by sliding it in one-quarter counterclockwise direction and turn off the calibrator.

**Step 3:** Install four alkaline batteries of same type in the battery holder with their positive and negative electrodes positioned correctly as indicated on the holder.

**Step 4:** After replacement, reattach the battery holder cover.

### **Indication of Battery Level**

The battery replacement indicator shows the battery level in five steps according to the measured voltage of the batteries.



Full battery: 

The battery level is below 50% full: 

The battery level is below 25% full: 

Low battery: 

The dictation flashes in sequence when getting charged.

Note that the battery replacement indicator is driven by directly measuring the battery voltage when the calibrator is in actual operation. Consequently, the indicator may read differently depending on the battery load condition (e.g., the load condition of the source output or on/ off state of the measurement function) if the batteries are too low. If the calibrator will be used under a wide variety of conditions, it is advisable that the battery replacement indicator be verified under heavy loads (MEASURE mode is on and the SOURCE mode is set to the 20 mA/10 V output).

## Connecting the **Charger**

### Warning

- Make sure the voltage of the AC power source matches the rated supply voltage of the **Charger**, before connecting the **Charger** to the AC power source.
- Do not use any **Charger** other than the dedicated **Charger** from the Company.
- Do not charge non Ni-Cd, Ni-MH batteries or wasted batteries.

**Step 1:** Make sure the calibrator is turned off.

**Step 2:** Insert the plug of the optional **Charger** into the **Charger** connection jack.

### **Note**

- Turn off the calibrator before connecting or disconnecting the **Charger** from AC power, plugging in/out the **Charger** connection jack.
- Plug out the **Charger** from the **Charger** connection jack of the calibrator when discharging.
- Do not charge the calibrator without any battery in.

### **Turning On the Power**

Pressing the Power key once when the power is off turns on the calibrator.

Pressing the Power key for 2 seconds turns off the calibrator.

### **Turning On/Off MEASURE Mode**

The measurement function is in off state after turning on the calibrator.

- If the MEASURE function is not needed and therefore turned off, power to the measurement circuit is also turned off within the calibrator. Thus, you can save on battery power if the calibrator is running on batteries.
- Turning off the MEASURE function causes the on-screen measured value to disappear, and the **“OFF”** indicator appears on the display simultaneously.
- To resume measurement when the MEASURE function is off, press the key once again.

### **Automatic Power-off**

When the calibrator is running on batteries and no key is operated for approximately ten minutes, the calibrator turns off automatically. The automatic power-off time could be reset in the factory default parts, see Chapter 10

“Factory Default”.

### **Turning On/Off the Backlight**

The LCD can be backlit. Pressing the key turns on the backlight, while pressing the key once again turns it off. This feature makes it easier for you to view the LCD when operating the calibrator in dark places or when carrying out source or measurement. Battery life shortens when the calibrator is operated on batteries.

#### **Note**

The backlight automatically turns off after 10 seconds. Press the key once more to relight it.

The time could be reset in the factory default parts, see Chapter 10 “Factory Default”.

## **7 Source**

From the calibrator, you can source a DC voltage, DC current, resistance, thermocouple, RTD, frequency, pulse signal or contact output.

### **⚠Warning**

To avoid electrical shock, do not apply more than the rated voltage, as marked on the calibrator, between terminals or between any terminal and earth ground. Always use the calibrator in locations with a voltage to ground below 30 V.

### **Caution**

- Do not apply any voltage to the output terminals for ranges other than 4-20mA simulating transmitter output. Otherwise, the internal circuitry may be damaged.
- The instrument has been calibrated without taking into account a voltage drop due to the resistance

component of the lead cables for source. Care must be taken therefore when drawing a load current since the voltage drop due to the resistance component (approximately  $0.1 \Omega$  on a round-trip basis) of the lead cables serves as an error.

## 7.1 Connecting Cables to Terminals

**For DC voltage, thermocouple, frequency, pulse or switch (Figure 5)**

**Step 1:** Connect the black lead cable for source to the COM output terminal and the red lead cable to the “VhZTcmA-” output terminal.

**Step 2:** Connect the other ends of the cables to the input of equipment under test while making sure the polarities are correct.

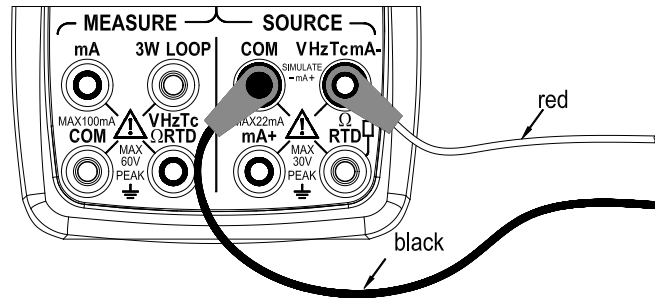

Figure 5 Sourcing DC voltage, TC, frequency, pulse and switch

## For DC current (Figure 6)

**Step 1:** Connect the black lead cable for source to the “VHzTcmA-” output terminal and the red lead cable to the “mA+” output terminal.

**Step 2:** Connect the other ends of the cables to the input of equipment under test while making sure the polarities are correct.

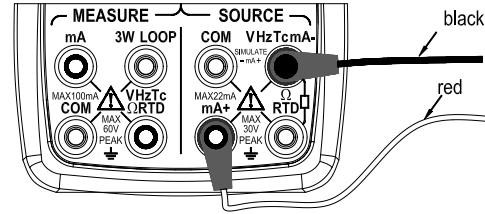

Figure 6 Sourcing DC Current

## For resistance and RTD signal (Figure 7)

**Step 1:** Connect black lead cables for source to the “ΩRTD” terminal and the red lead cable to the “VHzTcmA-” terminal.

**Step 2:** Connect the other ends of the cables to the input of equipment under test while making sure the polarities are correct.

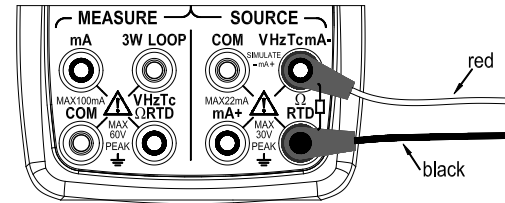

Figure 7 Sourcing Resistances and RTD

## 7.2 Sourcing DC Voltage

**Step 1:** Using the Function selector switch ( **FUNC** ) to select DC voltage source function, select the desired range from 100mV, 1V, and 10V by pressing the ( **RANG** ) key. The default value and unit of the selected source function and range shall be displayed in the lower part of the LCD.

**Step 2:** Set the output value digit by digit using ( ▲ ) / ( ▼ ) keys.

Each pair of ( ▲ ) / ( ▼ ) keys corresponds to each digit of the LCD reading. Each press of the ( ▲ ) / ( ▼ ) key increases or decreases the digit. Increasing the digit from 9 or decreasing it from 0 causes the digit to overflow or underflow, allowing you to set the output value without interruption. Holding down the ( ▲ ) / ( ▼ ) key continuously changes the digit in question. And the value won't change if it is increased or decreased to the Maxim or Minimum value. Pressing the ( **ZERO** ) key initializes the output set point to the default value (0).

**Step 3:** Pressing the ( **ON** ) key causes the indicator on the LCD to change from "OFF" to "ON". The calibrator sources the preset DC voltage between the output terminals.

**Step 4:** To turn off the output, press the ( **ON** ) key once again. The "OFF" appears on the LCD and no signals sourced between the terminals.

## 7.3 Sourcing DC Current

**Step 1:** Using the Function selector switch ( **FUNC** ) to select the desired source function 20mA .The default value and unit of the selected source function shall be displayed in the lower part of the LCD.

**Step 2:** Set the output value digit by digit using ( ▲ ) / ( ▼ ) keys.

Each pair of ( ▲ ) / ( ▼ ) keys corresponds to each digit of the LCD reading. Each press of the ( ▲ ) / ( ▼ ) key increases or decreases the digit. Increasing the digit from 9 or decreasing it from 0 causes the digit to overflow or underflow, allowing you to set the output value without interruption. Holding down the ( ▲ ) / ( ▼ )

key continuously changes the digit in question. And the value won't change if it is increased or decreased to the Maxim or Minimum value. Pressing the (ZERO) key initializes the output set point to the default value (0).

**Step 3:** Pressing the (ON) key causes the indicator on the LCD to change from "OFF" to "ON". The calibrator sources the preset DC voltage between the output terminals.

**Step 4:** To turn off the output, press the (ON) key once again. The "OFF" appears on the LCD and no signals sourced between the terminals.

### 7.3.1 Manual Set 25%, 100% 4–20 mA Function

You can set the source value in 4 mA or 16mA increments or decrements within 4–20 mA current.

**Step 1:** In DC current function, press the (25%100%) key to display "25%SET" on the lower part of the screen, and press once again to display "100%SET". The default source value will be showed simultaneously.

**Step 2:** Using each pair of (▲) / (▼) output setting keys, set the signal in a step-by-step manner. In 25% set point condition, you can set the signal in 4 mA increments or decrements in the order 4-8-12-16-20 by each press of the key. In 100% set point condition, you can set the signal in 16 mA increments or decrements in the order 4-20 by each press of the key. Pressing the (ZERO) key initializes the signal set point to the default value (4.00).



**Step 3:** Pressing the (ON) key causes the indicator on the LCD to change from "OFF" to "ON". The calibrator sources the preset 4–20 mA current signal between the output terminals.



**Step 4:** To turn off the output, press the (ON) key once again. The "OFF" appears on the LCD and no signals sourced between the terminals.

### 7.3.2 Auto-stepping and auto-sweeping 4-20mA function

You can set a 4–20 mA range within which to source out current in 4 -20mA increments or decrements in auto

–stepping mode or in auto-sweeping mode. It requires 80 seconds to finish a 4-20mA cycle for auto-sweeping mode and 20 seconds for auto-stepping mode.

**Step 1:** In DC current function, press (  ) key to display auto-stepping mode signal “” on the lower part of the screen, and press once again to display auto-sweeping mode signal “”. The default source value will be showed simultaneously.

**Step 2:** Pressing the ( **ON** ) key causes the indicator on the LCD to change from “” to “”. The calibrator sources the default 4–20 mA current signal between the output terminals.

**Step 3:** Pressing the ( **START** ) key starts the auto-stepping and auto-sweeping mode. The “RUN “ mark shall be displayed in the lower part of the LCD.

**Step 4:** Pressing the ( **START** ) key once more stops the auto-stepping and auto-sweeping mode. The “RUN “ mark disappears. The terminals source the value displayed on the screen.

**Step 5:** Pressing the ( **ON** ) key stops sourcing and “” mark displayed on the screen. No signals sourced between the terminals.

#### **Tips:**

- Press the ( **START** ) key again to continue the auto-stepping and auto-sweeping mode after stopping them, and “RUN” mark displays on the lower part of the screen.
- Using the ( **START** ) key to start mA auto-stepping and auto-sweeping mode is only available when the source function is in  state.
- Starting the mA auto-sweeping mode needs to turn off the measurement mode, which is unavailable when the auto-stepping mode is on. Otherwise, the LCD displays “NO .OP”. Thus, the mA auto-stepping mode



and the measurement function cannot work simultaneously.

### 7.3.3 mA% display

In mA source function, press the (**RANGE**) key and converts the preset source value into mA% mode in the following way, which will be shown on the lower part of the LCD.

$$\text{mA \%} = \frac{100(\text{current measured value mA}-4\text{mA})}{16 \text{ mA}} \%$$

Press the (**RANGE**) key to return to the current preset value, which will be shown on the lower part of the LCD.

#### Tips:

You cannot undertake increment or decrement set in mA% mode. To achieve this, you need to press the (**RANGE**) key once more to return back to source set mode.

### 7.3.4 4-20 mA simulate transmitter source

Connect the calibrator and the loop power as listed in Figure 8, and operate in steps shown in sourcing DC current.

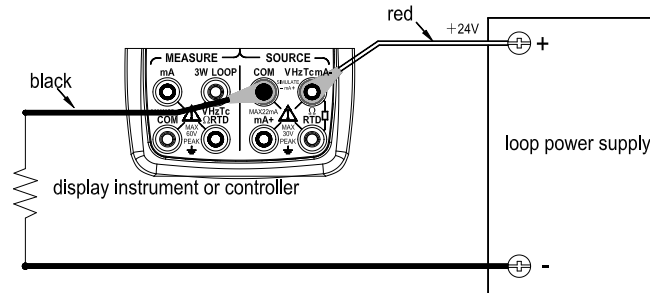

Figure 8 4-20 mA simulate transmitter source

## 7.4 Sourcing Resistance

- Firstly, the calibrator sources a resistance signal by receiving the resistance-measuring current  $I$  supplied from the device being calibrated (such as a resistance meter) and then delivering the voltage  $V$  proportional to the preset resistance  $R$  between the output terminals, and thus producing the equivalent resistance  $R = V/I$ . Consequently, the calibrator sources the signal correctly only for such devices that employ this method of measurement.
- The allowable range of the resistance measuring current  $I$  that the calibrator receives from a resistance measuring device under calibration is rated as 0.1 mA to 3 mA. To ensure accuracy, the resistance measuring current  $I$  from the device under calibration shall be strictly confined within the range. For further details, see Chapter 18, “Specification”.
- Any resistance signal being sourced does not include the resistance component of the lead cables for source. The whole resistance, when measured at the ends of the lead cables for source, is given by adding the resistance of the lead cables (approximately  $0.1\Omega$  on a round-trip basis) to the sourced resistance signal. For source of precise resistance signals, use three-wire or four-wire connection.
- If capacitance between the terminals of a device under calibration is greater than  $0.1\mu\text{F}$ , the calibrator may fail to source correct resistance signals.

**Step 1:** Using the function selector switch ( **FUNC** ) , select Ohm function. Using the ( **RANGE** ) key, select the desired range. The selected function and the default range source value and unit shall be shown in the lower part of the LCD.

**Step 2 :**Set the output value digit by digit using each pair of ( **▲** ) / ( **▼** ) keys.

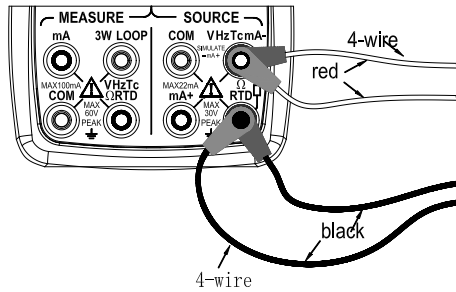

Each pair of (▲) / (▼) keys corresponds to each digit of the LCD reading. Each press of the (▲) / (▼) key increases or decreases the digit. Increasing the digit from 9 or decreasing it from 0 causes the digit to overflow or underflow, allowing you to set the output value without interruption. Holding down the (▲) / (▼) key continuously changes the digit in question. And the value won't change if it is increased or decreased to the Maxim or Minimum value. Pressing the (ZERO) key initializes the output set point to the default value(0). Figure

9 connection method based on three-wire and four-wire

**Step 3:** Pressing the (ON) key causes the SOURCE indicator on the LCD to change from "OFF" to "ON". The calibrator sources the preset resistance value between the output terminals.

**Step 4:** To turn off the output, press the (ON) key once again. The "OFF" appears on the LCD and no signals sourced between the terminals.

The connection method based on three-wire and four-wire are listed in Figure 9:

## 7.5 Simulate Sourcing TC

The calibrator is designed with an internal temperature sensor. To calibrate a device with built-in reference junction temperature compensation by sourcing a thermoelectromotive force with the calibrator without using non-external 0C reference junction compensation means, use the RJ sensor function. Select simulate TC

source function, in which RJ sensor goes on work automatically. The “RJ-ON” mark displays on the middle part of the screen.

**Step 1:** Using the function selector switch ( **FUNC** ) , select simulate TC source function. Using the ( **RANGE** ) key, select the desired range from K, E, J, T, B, N, R, S. The selected function and the default range source value and unit shall be shown in the lower part of the LCD.

**Step 2 :**Set the output value digit by digit using each pair of ( ▲ ) / ( ▼ ) keys.

Each press of the ( ▲ ) / ( ▼ ) key increases or decreases the digit. Increasing the digit from 9 or decreasing it from 0 causes the digit to overflow or underflow, allowing you to set the output value without interruption.

Holding down the ( ▲ ) / ( ▼ ) key continuously changes the digit in question. And the value won't change if it is increased or decreased to the Maxim or Minimum value. Pressing the ( **ZERO** ) key initializes the output set point to the default value(the default value of a typical B type is 600°C).

**Step 3:** Pressing the ( **ON** ) key causes the SOURCE indicator on the LCD to change from “OFF” to “ON” . A thermoelectromotive force based on the temperature detected by the RJ sensor develops between the output terminals.

**Step 4:** To turn off the output, press the ( **ON** ) key once again. The “OFF” appears on the LCD and no signals sourced between the terminals.

Note:

If you don't need the reference junction compensation, press the ( **RJ-ON** ) key to shut off. The calibrator source a value with using external 0°C reference junction compensation means, and the “RJ-ON” mark vanishes.

Press the ( **RJ-ON** ) key once more to start the reference junction compensation and the “RJ-ON” mark displays on the middle of the screen.

### Tips:

- The TC source function is unavailable if the TC /RTD measurement function is on, which is only usable when the calibrator is in non-TC or RTD measurement function.
- Using the reference junction compensation, the present environmental temperature measured by the RJ sensor is shown on the right corner of the LCD, which disappears when the reference junction compensation is shut off.
- The temperature unit is defaulted as °C. To convert into °F, see Chapter 10 “Factory Default” .

### 7.5.1 Temperature Monitor Function

The calibrator offers a temperature monitor function, which is convenient for the user to observe the voltage value sourced between the output terminals in TC source function.

In TC source function, pressing the (**START**) key ,LCD shows the voltage value sourced between the output terminals,(varies responding to the changes of the reference junction compensation). Pressing the (**START**) key once more, LCD shows the preset temperature value.

Note: the preset value shall be changed only when the temperature displays.

### 7.6 Sourcing RTD

- Firstly, the calibrator sources a resistance signal by receiving the resistance-measuring current  $I$  supplied from the device being calibrated (such as a resistance meter) and then delivering the voltage  $V$  proportional to the preset resistance  $R$  between the output terminals, and thus producing the equivalent resistance  $R = V/I$ . Consequently, the calibrator sources the signal correctly only for such devices that employ this method of measurement.
- The allowable range of the resistance measuring current  $I$  that the calibrator receives from a resistance

measuring device under calibration is rated as 0.1 to 3 mA. To ensure accuracy, the resistance measuring current I from the device under calibration shall be strictly confined within the range. For further details, see Chapter 18, “Specification”.

- Any resistance signal being sourced does not include the resistance component of the lead cables for source. The whole resistance, when measured at the ends of the lead cables for source, is given by adding the resistance of the lead cables (approximately  $0.1\Omega$  on a round-trip basis) to the sourced resistance signal. For source of precise resistance signals, use three-wire or four-wire connection.

**Step 1:** Using the function selector switch ( **FUNC** ) , select RTD function. Using the ( **RANGE** ) key, select a desired RTD range from PT100, PT200, PT500, PT1000, Cu10, Cu50. The selected function and the default range source value and unit shall be shown in the lower part of the LCD.

**Step 2 :**Set the output value digit by digit using each pair of ( ▲ ) / ( ▼ ) keys.

Each press of the ( ▲ ) / ( ▼ ) key increases or decreases the digit. Increasing the digit from 9 or decreasing it from 0 causes the digit to overflow or underflow, allowing you to set the output value without interruption.

Holding down the ( ▲ ) / ( ▼ ) key continuously changes the digit in question. And the value won't change if it is increased or decreased to the Maxim or Minimum value. Pressing the ( **ZERO** ) key initializes the output set point to the default value(0).

**Step 3:** Pressing the ( **ON** ) key causes the SOURCE indicator on the LCD to change from “OFF” to “ON” . The calibrator sources the preset resistance value between the output terminals.

**Step 4:** To turn off the output, press the ( **ON** ) key once again. The “OFF” appears on the LCD and no signals sourced between the terminals.

The connection methods based on three-wire and four-wire are shown in Figure 9:

## Tips:

The RTD source function is unavailable if the TC /RTD measurement function is on, which is only usable when the calibrator is in non-TC or RTD measurement function.

### 7.6.1 Temperature Monitor Function

The calibrator offers a temperature monitor function, which is convenient for the user to observe the resistance value sourced between the output terminals.

In RTD source function, pressing the ( **START** ) key ,LCD shows the resistance value sourced between the output terminals. Pressing the ( **START** ) key once more, LCD shows the preset temperature value.

Note: the preset value shall be changed only when the temperature displays.

### 7.7 Sourcing Frequency

The calibrator can source a constant pulse signal responding to the preset frequency and amplitude.

**Step 1:** Using the function selector switch ( **FUNC** ) , select frequency source function. The LCD shows the

default frequency value 10 Hz and the frequency symbol  in the lower part.

**Step 2:** Using the ( **RANG** ) key, select a desired frequency range from 100Hz, 1KHz, 10Hz, 100KHz. The selected function and the default range source value and unit shall be shown in the lower part of the LCD.

**Step 3:** Set the output value digit by digit using each pair of ( **▲** ) / ( **▼** ) output setting keys.

Each pair of ( **▲** ) / ( **▼** ) keys corresponds to each digit of the LCD reading. Each press of the ( **▲** ) / ( **▼** ) key increases or decreases the digit. Increasing the digit from 9 or decreasing it from 0 causes the digit to overflow or underflow, allowing you to set the output value without interruption. Holding down the ( **▲** ) / ( **▼** ) key continuously changes the digit. And the value won't change if it is increased or decreased to the Maxim or

Minimum value.

**Step 4:** Pressing the (**Vpeak**) key once switches to amplitude setting mode. The LCD provides a reading of 1V.

**Step 5:** Set the output value digit by digit using each pair of (**▲**) / (**▼**) output setting keys.

Each pair of (**▲**) / (**▼**) keys corresponds to each digit of the LCD reading. Each press of the (**▲**) / (**▼**) key increases or decreases the digit. Increasing the digit from 9 or decreasing it from 0 causes the digit to overflow or underflow, allowing you to set the output value without interruption. Holding down the (**▲**) / (**▼**) key continuously changes the digit. And the value won't change if it is increased or decreased to the Maxim or Minimum value.

**Step 6:** To re-enter into the frequency set mode, press the (**FREQ**) key to set the frequency.

**Step 7:** Pressing the (**ON**) key causes the **SOURCE** indicator on the LCD to change from "OFF" to "ON". The calibrator sources constant pulse signals responding to the preset frequency and amplitude between the output terminals.

**Step 8:** To turn off the output, press the (**ON**) key once again. The "OFF" appears on the LCD and no signals sourced between the terminals.

#### **Tips:**

- The frequency source function is unavailable if the frequency measurement function is on, which is only usable when the calibrator is in non-frequency measurement function.
- The frequency range could only be changed by pressing (**RANGE**) key in the frequency set mode.
- The frequency value and range could be changed when the frequency source function is both in "ON" or "OFF" state.

## **7.8 Sourcing Number of Pulses**



The calibrator can source a preset number of pulse signal responding to the preset frequency and amplitude.

**Step 1:** Using the function selector switch ( **FUNC** ) , select pulse source function. The LCD shows the default value 10 Hz and the number of pulses mark  in the lower part.

**Step 2:** Using the ( **RANGE** ) key, select a desired frequency range from 100Hz, 1KHz, 10Hz. The selected function and the default range source value and unit shall be shown in the lower part of the LCD.

**Step 3:** Set the output value digit by digit using each pair of ( ▲ ) / ( ▼ ) output setting keys. Each pair of ( ▲ ) / ( ▼ ) keys corresponds to each digit of the LCD reading. Each press of the ( ▲ ) / ( ▼ ) key increases or decreases the digit. Increasing the digit from 9 or decreasing it from 0 causes the digit to overflow or underflow, allowing you to set the output value without interruption. Holding down the ( ▲ ) / ( ▼ ) key continuously changes the digit . And the value won't change if it is increased or decreased to the Maximum or Minimum value.

**Step 4:** Pressing the ( **Vpeak** ) key once switches to amplitude setting mode. The LCD provides a reading of 1V.

**Step 5:** Set the output value digit by digit using each pair of ( ▲ ) / ( ▼ ) output setting keys. Each pair of ( ▲ ) / ( ▼ ) keys corresponds to each digit of the LCD reading. Each press of the ( ▲ ) / ( ▼ ) key increases or decreases the digit. Increasing the digit from 9 or decreasing it from 0 causes the digit to overflow or underflow, allowing you to set the output value without interruption. Holding down the ( ▲ ) / ( ▼ ) key continuously changes the digit. And the value won't change if it is increased or decreased to the Maximum or Minimum value.

**Step 6:** Pressing the ( **CYC** ) key , enter into the pulse number set mode, and the LCD shows the default number of 1 CYC in the lower part.

**Step 7:** Set the output value digit by digit using each pair of (▲) / (▼) output setting keys.

Each pair of (▲) / (▼) keys corresponds to each digit of the LCD reading. Each press of the (▲) / (▼) key increases or decreases the digit. Increasing the digit from 9 or decreasing it from 0 causes the digit to overflow or underflow, allowing you to set the output value without interruption. Holding down the (▲) / (▼) key continuously changes the digit. And the value won't change if it is increased or decreased to the Maximum or Minimum value.

**Step 8:** To re-enter into the frequency set mode, press the (FREQ) key to set the frequency.

**Step 9:** Pressing the (ON) key causes the SOURCE indicator on the LCD to change from "OFF" to "ON", and the calibrator sources low level between the output terminals.

**Step 10:** Pressing the (START) key the calibrator sources the set number of pulse responding to the preset frequency and amplitude, LCD shows the symbol "RUN".

**Step 11:** When source is complete, the calibrator automatically turns off the output and ceases operation. The "RUN" symbol disappears from the LCD.

**Step 12:** To turn off the output, press the (ON) key once again. The "OFF" appears on the LCD and no signals sourced between the terminals.

#### **Tips:**

- The contact output source function is unavailable if the frequency measurement function is on, which is only usable when the calibrator is in non-frequency measurement function.
- The frequency range of the pulse could only be changed by pressing (RANGE) key in the frequency set mode.
- When the "RUN" symbol vanishes from the LCD, you can change the frequency and amplitude both when

the source function is in "ON" or "OFF".

- In the pulse sourcing process, pressing the (START) key causes to stop the output, and the "RUN" mark vanishes from the LCD. Press the (START) key once more to restart the sourcing function.
- Restarting the pulse output requires the source function is in "ON" state.

## 7.9 Sourcing Switch

You can turn on or off the output terminals by using the contact output function. An FET is used as the contact-switching device.

**Step 1:** Using the function selector switch (FUNC), select the contact output source function. The LCD shows the default value 10Hz, and the "  "symbol.

**Step 2:** Using the (RANGE) key, select the desired frequency from 100Hz, 1KHz, 10 KHz, and 100KHz.

**Step 3:** Set the output value digit by digit using each pair of (▲) / (▼) output setting keys.

Each pair of (▲) / (▼) keys corresponds to each digit of the LCD reading. Each press of the (▲) / (▼) key increases or decreases the digit. Increasing the digit from 9 or decreasing it from 0 causes the digit to overflow or underflow, allowing you to set the output value without interruption. Holding down the (▲) / (▼) key continuously changes the digit. And the value won't change if it is increased or decreased to the Maximum or Minimum value.

**Step 4:** Pressing the (ON) key causes the SOURCE indicator on the LCD to change from "OFF" to "ON".

**Step 5:** To turn off the output, press the (ON) key once again. The "OFF" appears on the LCD and no signals sourced between the terminals.

### Tips:

- The contact output source function is unavailable if the frequency measurement function is on, which is only usable when the calibrator is in non-frequency measurement function.
- You cannot set the amplitude and pulse number in contact output function.
- The contact output is polarity. Generally, connect the positive polarity with the H jack of the calibrator and the negative polarity with the L jack.
- Note the maxim allowable current of the contact output is 50mA.

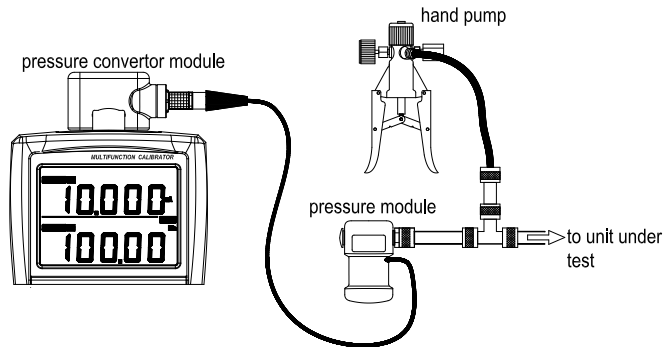

Figure 10 Sourcing Pressure

## 7.10 Sourcing Pressure

The calibrator source pressure by measuring the pressure from a pump or any other device, and shows the value in the lower part of the LCD. Figure 10 demonstrates how to connect the pump with the pressure module

so as to make it into a calibrated source. Ranges and types of the pressure module have various options. See “Accessories” for more information. Due to the difference in medium and accuracy of different pressure modules, user needs to read the Manual before operating it. Follow the steps listed below to source pressure with a proper pressure module (assisted by the tested technical pressure).

### **⚠Warning**

To avoid a sudden release of the pressure system, do shut off the valve to release the pressure gradually before connecting the pressure module with the pipe.

### **Caution**

- To avoid any mechanical damage to the pressure module, do not apply any force higher than 13.5 Nm(10 ft.1bs) to the pressure pipe mouths(or the module and the pipe mouth).Do apply the specified force when connecting the pipe or the adapter.
- To avoid any damage to the pressure module due to over pressed, do not apply any pressure higher than the maximum value marked or specified.
- To avoid any corrosive damage, use the pressure module only with specified materials. Refer to the printing on the pressure module or the pressure module instruction sheet for the acceptable material compatibility.

**Step 1:** Connect the pressure module and calibrator. The screw of the pressure module pipe is compatible to the 1/4 inch NPT connector. If you have other requirement, contact the vendor.

**Step 2:** Using the function selector switch ( **FUNC** ) , select the pressure source function. The LCD shows “OKPa” in the lower part.

**Step 3:**Pressing the **ON** key turns on the function, the calibrator connects and senses the type of the pressure

module and sets the range automatically. If it fails to connect, the LCD shows “NO.OP” in the lower part.

**Step 4:**Zero off the reading following the pressure module manual. When the reading overtops the 95 percentage of maxim value of the range, the LCD shows “ERR” in the lower part. Pressing the ( **ZERO** ) key initializes the calibrator to 0,and “△”symbol shows on the left lower part of the LCD.

**Step 5:** Apply pressure on the pipe with the pressure source until the desired pressure value displayed on the LCD.

#### **Tips:**

- According to chapat10.5 to set “DPM” before source pressure.
- For absolute pressure module, the calibrator saves the zero-off value and reuses the value automatically. Therefore, user does not need to zero off the calibration value for each use.
- You cannot set the pressure value on the LCD in pressure source function.

#### **7.10.1 Auto-hold of pressure source**

In pressure source function, when the switch measurement mode is selected, the calibrator preserves the pressure value and the switch state on the LCD automatically. Pressing the ( **HOLD** ) key releases the HOLD mode automatically.

#### **7.11 Zero-off function**

In any range of DC voltage, DC current, ohm, TC and RTD functions, pressing the ( **ZERO** ) key selects clearing off function, which initializes the preset source value for the convenience of user to reset source value.

In pressure source function, pressing the ( **ZERO** ) key clears off the value. For absolute pressure module, the calibrator saves the zero-off value and reuses the value automatically.

In frequency, pulse, contact output functions, the ( **ZERO** ) key is unavailable.

## 8 Measurement

From the calibrator, you can measure a DC voltage, DC current, resistance, thermocouple, RTD, frequency, continuity, switch and pressure.

### **⚠Warning**

- In an application where the calibrator is used together with the supplied lead cables for measurement, the allowable voltage to ground of the input terminals is 60 V<sub>peak</sub> maximum. To avoid electrical shock, do NOT use the calibrator at any voltage exceeding the maximum voltage to ground.
- The allowable voltage to ground when the supplied thermocouple convertor is attached to the input terminals is 60V peak maximum. To avoid electrical shock, do not use the terminal adapter for measuring any circuit voltage exceeding the maximum voltage to ground.

### **Tips:**

- When turning on the calibrator, the measurement function is in off mode to save battery power. You need to press the (ON) key to facilitate the function.
- When the mA source function selects the auto-sweeping mode, you cannot start the measurement function by pressing the (ON) key. Otherwise, the LCD shows “NO. OP”
- With the (HOLD) key, you can hold the measured value.
- When no measurement needs to be made, turn off the MEASURE mode by pressing the (ON) key. The measured value shown on the LCD disappears and power to the internal measuring circuit is cut off. This strategy saves on battery power.
- The reading of a measured value is updated differently responding to different measurement function.

LCD shows “ - - - - ” on the upper part when shifting the range. If the input is over ranged, the measured value on the LCD reads as “oL”.

## 8.1 Connecting Cables to Terminals

**For DC voltage, Ohm, frequency, consistency or switch measurement (Figure 11)**

**Step 1:** Connect the black lead cable for measurement to the “COM” input terminal and the red lead cable to the “VHzTc ΩRTD” input terminal.

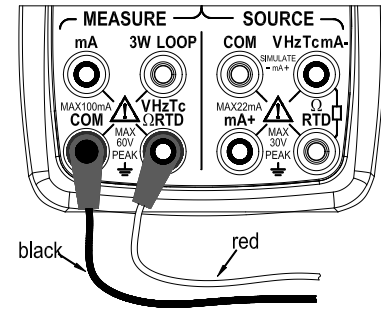

Figure 11 Measuring DC voltage, ohms, frequency, continuity and switch

**Step 2:** Connect the other end of the cable to the measuring terminals of equipment under test while making sure the polarities are correct.

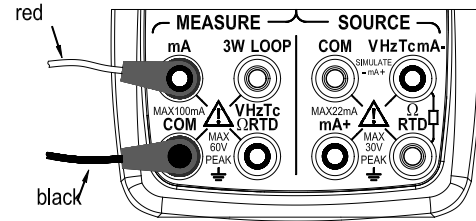

Figure 12 Measuring DC current

**For DC current signal (Figure 12)**

**Step 1:** Connect the black lead cable for measurement to the “COM” input terminal and the red lead cable to



the "mA" input terminal.

**Step 2:** Connect the other end of the cable to the measuring terminals of equipment under test while making sure the polarities are correct.

### For thermocouple signal (Figure 13)

**Step 1:** Connect the thermocouple converter to the input terminals. This will help you connect the cables easily.

**Step 2:** Connect between TC terminals. The positive output lead wire of the thermocouple to the H terminal of the thermocouple converter and the negative output lead wire to the L terminal.

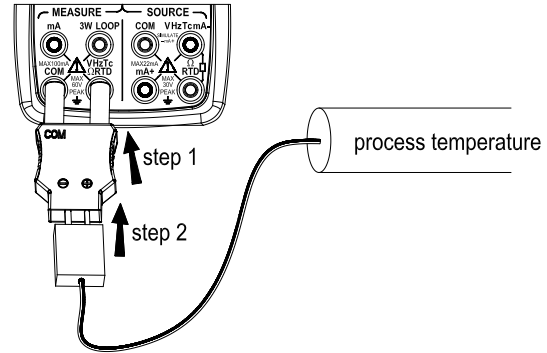

Figure 13 Measuring TC

### Three wire connection method for RTD signal (Figure 14)

**Step 1:** Connect one black lead cable for measurement to the "COM" input terminal and another black lead to the "3W" terminal. Connect the red lead cable to the "VHzTcΩRTD" input terminal.

**Step 2:** Connect the three clips of the cables to the measuring terminals of equipment under test while

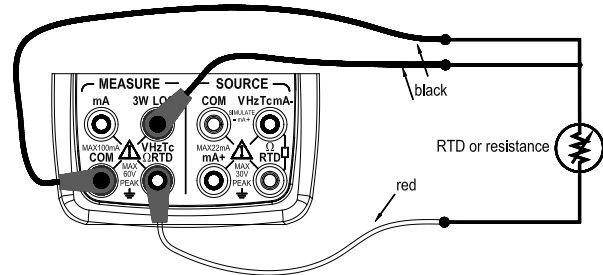

Figure 14 RTD signal with 3w method

making sure the polarities are correct.

### **⚠Warning**

- Before connecting the calibrator to the device under test, cut off the power to the device.
- Do not apply any voltage or current exceeding the allowable voltage (55 V) or current (55 mA). Otherwise, there will be a danger of not only damage to the instrument but also personal injury due to electrical shock.
- Mistaking the H voltage input terminal for the mA current input terminal, and vice versa, when wiring, is extremely dangerous. NEVER make this mistake.
- The current input terminals are equipped with a built-in current input protection fuse. Over-current input to the terminals will cause the fuse to blow. If the fuse is blown, replace it with one with the specified ratings. For details on fuse replacement, see "replacing the battery and fuse".

### **⚠Warning**

If you make a mistake in wiring or in the operating procedure in this measurement task, there will be a danger of not only damage to the instrument but also personal injury due to electrical shock. Exercise the utmost care when carrying out the measurement task.

## **8.2 Measuring DC Voltage**

**Step 1:** Make sure the lead cables for measurement are not connected to the measuring instrument under test.

**Step 2:** Using the function selector switch ( **FUNC** ), select DC Voltage measurement function.

**Step 3:** Connect the lead cables for measurement to the measuring terminals of the measuring instrument under test.

**Step 4:** Using the ( **RANGE** ) key, select a desired range from 50mV, 500mV, 5V, 50V. The selected function

and the measured value and unit shall be shown in the upper part of the LCD.

### 8.3 Measuring DC Current

**Step 1:** Make sure the lead cables for measurement are not connected to the measuring instrument under test.

**Step 2:** Using the function selector switch ( **FUNC** ) , select DC Current measurement function.

**Step 3:** Connect the lead cables for measurement to the measuring terminals of the measuring instrument under test.

**Step 4:** The selected function and the measured value and unit shall be shown in the upper part of the LCD.

#### 8.3.1 mA % Display

In mA measurement function, pressing ( **RANGE** ) key in the following way converts the measured value into mA% mode, which will be shown on the upper part of the LCD.

$$\text{mA \%} = \frac{100(\text{current measured value mA}-4\text{mA})}{16 \text{ mA}} \%$$

Press the ( **RANGE** ) key again to return to the current measured value, which will be shown on the upper part of the LCD.

#### 8.3.2 Using As 24-V Loop Power Supply

This function helps to turn on a 24V loop power supply connected in line with the measured DC current circuit, in which you can use the calibrator as a loop power supply to calibrate a 2-wire converter by undertaking the following steps:

**Step 1:** When the calibrator is in current measurement function, pressing the ( **LOOP** ) key causes the LCD shows **LOOP** symbol. And the built-in 24V loop power of the calibrator will be turned on.

**Step 2:** Connect the calibrator with the loop current terminal of the converter as shown in Figure 15.

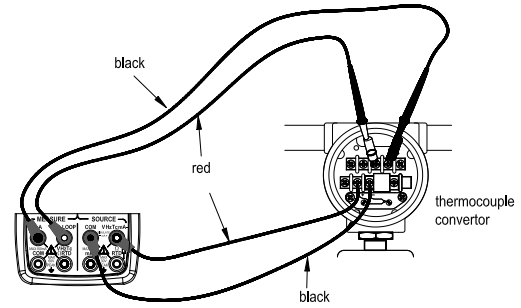

Figure 15 Using 24v loop power circuit supply

**Note:**

Since the function discussed above requires a significant amount of DC current (25 mA), operation on batteries will reduce the battery life considerably.

### 8.4 Measuring Resistance

**Step 1:** Make sure the lead cables for measurement are not connected to the measuring instrument under test.

**Step 2:** Using the function selector switch ( **FUNC** ) , select resistance measurement function.

**Step 3:** Connect the lead cables for measurement to the measuring terminals of the measuring instrument under test as shown in Figure 11.

**Step 4:** Using the measurement ( **RANGE** ) key, select the desired range from 500Ω,5K. The selected function and the measured value and unit shall be shown in the upper part of the LCD.

### 8.5 Measuring Temperature with Thermocouple (TC)

**Note:**

Any voltage higher than 60V won't work on the measured circuit if applying the thermocouple convertor to the given input terminal.

**Step 1:** Make sure the lead cables for measurement are not connected to the measuring instrument under test.

**Step 2:** Using the function selector switch (**FUNC**), select TC measurement function. Using the measurement (**RANGE**) key, select the desired range from K, E, J, T, B, N, R, S.

**Step 3:** Connect the thermocouple convertor to the jack under test as shown in Figure 13. The selected function and the measured value and unit shall be shown in the upper part of the LCD.

**Tips:**

- The TC measurement function is unavailable if the TC/RTD source function is on, which is only usable when the calibrator is in non-TC/RTD source function.
- If there has been a sudden change in the operating ambient temperature of the calibrator, wait until the built-in reference junction compensation stabilizes. Avoid using the calibrator in locations exposed to wind from such apparatus as an airconditioner.

**8.5.1 Using RJ sensor**

Select TC measurement function, in which RJ sensor goes on work automatically, press(**RJ-ON**)key to shut off. Both the "RJ-ON" mark and the environmental temperature display vanish. Press the (**RJ-ON**) key once more to start the reference junction compensation and the "RJ-ON" mark displays on the middle of the screen, and the environmental temperature displays on the screen.

**8.5.2 Temperature Monitor Function**

The calibrator offers a temperature monitor function, which is convenient for the user to observe the voltage value measured from the input terminals.

In TC measurement function, pressing the ( **T.DISPLAY** ) key ,the display part shows the voltage value measured between the input terminals. Pressing the ( **T.DISPLAY** ) key once more, the display part shows the measured temperature value.

## 8.6 Measuring Temperature with RTD

**Step 1:** Make sure the lead cables for measurement are not connected to the measuring instrument under test.

**Step 2:** Using the function selector switch ( **FUNC** ) , select RTD measurement function.

**Step 3:** Connect the lead cables for measurement to the measuring terminals of the measuring instrument under test as shown in Figure 14.

**Step 4:** Using the measurement ( **RANGE** ) key, select a desired range from PT100,PT200,PT500,PT1000,Cu10,C50.The selected function and the default measured value and unit shall be shown in the lower part of the LCD.

### Tips:

- The RTD measurement function is unavailable if the TC /RTD source function is on, which is only usable when the calibrator is in non-TC or RTD source function.
- The calibrator defaults the 3-wire connection method when measuring RTD. When applying the 2-wire connection method, connecting the same RTD measurement .Pay special attention to linking the “COM” and “LOOP” terminals **with short circuit line**, otherwise, there would be a big error.

### 8.6.1 Temperature Monitor Function

The calibrator offers a temperature monitor function, which is convenient for the user to observe the resistance value measured from the input terminals.

In TC measurement function, pressing the ( **T.DISPLAY** ) key ,the display part shows the resistance value measured from the input terminals. Pressing the ( **T.DISPLAY** ) key once more, the display part shows the measured temperature value.

## **8.7 Measuring Frequency**

**Step 1:** Make sure the lead cables for measurement are not connected to the measuring instrument under test.

**Step 2:** Using the function selector switch ( **FUNC** ) , select frequency measurement function.

**Step 3:** Connect the lead cables for measurement to the measuring terminals of the measuring instrument under test.

**Step 4:** Using the measurement ( **RANGE** ) key, select the suitable range from 500Hz,5KHz,50KHz.The selected function and the measured value and unit shall be shown in the upper part of the LCD.

### **Tips:**

The frequency measurement function is unavailable if the frequency, pulse, contact or pressure source function is on, which is only usable when the calibrator is in non-frequency, pulse, contact or pressure source function.

## **8.8 Measuring switch**

The calibrator could measure the connection or disconnection signal of the switch.

Using the function selector switch ( **FUNC** ) , select switch measurement function. LCD displays switch symbol

“” on the upper part. The beeper sounds for one second if the state of the switch under measurement is changing.

## 8.9 Measuring Continuity

Continuity measurement is used to detect the intactness of the circuit (e.g. a resistance lower than 50). Using the function selector switch ( **FUNC** ) , select continuity measurement function. LCD displays continuity symbol

“” on the upper part. Connecting the devices as shown in Figure 11, the beeper sounds continuously if the loop circuit resistance under measurement is less than 50Ω, and LCD shows the present measured resistance value.

## 8.10 Measuring Pressure

Ranges and types of the pressure module have various options. See “Accessories” for more information. Due to the difference in medium and accuracy of different pressure modules, user needs to read the Manual before operating it. Real pressure module can work as a surface pressure module by opening the L input terminal exhausting the air. Follow the steps listed below to connect the tested technical pressure pipe with a proper pressure module.

### **Warning**

To avoid a sudden release of the pressure system, do shut off the valve to release the pressure gradually before connecting the pressure module with the pipe.

### **Caution**

- To avoid any mechanical damage to the pressure module, do not apply any force higher than 13.5 Nm(10



ft.1bs) to the pressure pipe mouths(or the module and the pipe mouth).Do apply the specified force when connecting the pipe or the adapter.

- To avoid any damage to the pressure module due to over pressed, do not apply any pressure higher than the maximum value marked or specified.
- To avoid any corrosive damage, use the pressure module only with specified materials. Refer to the printing on the pressure module or the pressure module instruction sheet for the acceptable material compatibility.

**Step 1:** Connect the pressure module and calibrator as shown in Figure 10. The screw of the pressure module pipe is compatible to the 1/4 inch NPT connector. If you have other requirement, contact the vendor.

**Step 2:** Using the function selector switch ( **FUNC** ) , select the pressure measurement function. The calibrator connects and senses the type of the pressure module and sets the range automatically. If it fails to connect, the LCD shows “NO.OP” in the upper part.

**Step 3:**Zero off the reading following the pressure module manual. When the reading overtops the 95 percentage of maxim value of the range, the LCD shows “ERR” in the lower part. Pressing the ( **AVG** ) key initializes the calibrator to 0,and “△”symbol shows on the left upper part of the LCD.

#### **Tips:**

- According to chapat10.5 to set “DPM” before measure pressure.
- For absolute pressure module, the calibrator saves the zero-off value and reuses the value automatically. Therefore, user does not need to zero off the calibration value for each use.
- Press ( **RANGE** ) to switch range between MPa and KPa, when measured value in MPa range.

## **8.11 Measurement-filtering function**

Selecting measurement-filtering function stabilizes the measured value displayed on LCD.

In DCV, DCmA, OHM, TC, RTD function, pressing the ( **AVG** ) key causes calculation of the average of the samples. LCD shows the “**AVG**” symbol. Repeating the ( **AVG** ) key cancels the calibration and the “**AVG**” symbol disappears.

## 8.12 Measured Value holding function

Apart from the continuity and switch measurement functions, the reading-hold function can also be used to preserve the current measured value on the upper part of LCD, which consequently doesn't refresh the measured value.

Pressing the ( **HOLD** ) key selects reading-hold mode, and LCD displays “**HOLD**” symbol. To cancel the selection, press the ( **HOLD** ) key again and the “**HOLD**” symbol disappears.

## 9 Environmental Temperature Test

The calibrator can measure the surrounding environmental temperature, and displays it on the top right corner. After turning on the calibrator, to observe the surrounding environment, pressing the ( **TEMP** ) key causes LCD displays the temperature value and the unit in the top right corner. Repeating the ( **TEMP** ) key cancels the measurement and the symbol disappears.

## 10 Factory Default

You can reset the factory default of the calibrator.

When turning on the calibrator, pressing the ( **HOLD** ) key immediately to enter the default set. And the “SPFC” symbol is shown on the top right corner. LCD displays the default function on the upper part and the default

value on the lower part.

### 10.1 Setting Auto -power off time

**Step 1:** Pressing the MEASURE (ON) key, LCD displays “AP.OFF” symbol on the upper part, indicating automatic power- off setting mode.

**Step 2:** Set the time within 0-60 minute range by using the second pair of (▲)/(▼) counting from right to left. Each press of the (▲) / (▼) key causes 10 -minute increments or 10- minute decrement with constant setting. Constant press of the key causes increments or decrement of the value in sequence. The value won't change when reaching the maximum or minimum value. The time unit is minute.

**Step 3:** Pressing the SOURCE (ON) key, LCD displays “SAVE” symbol on the upper part for 1s.

#### Tips:

Zero default value (0) represents no automatic power-off function.

### 10.2 Setting Backlight time

**Step 1:** Pressing the MEASURE (ON) key ,LCD displays “BL.OFF” symbol on the upper part, indicating backlight time setting mode.

**Step 2:** Set the time by using the pair of (▲) / (▼) . And the unit is second.

Each pair of (▲) / (▼) keys corresponds to each digit of the LCD reading. Each press of the (▲) / (▼) key increases or decreases the digit. Increasing the digit from 9 or decreasing it from 0 causes the digit to overflow or underflow, allowing you to set the output value without interruption. Holding down the (▲) / (▼) key continuously changes the digit . And the value won't change if it is increased or decreased to the Maxim or Minimum value. The setting range is confined within 0-3600 seconds.

**Step 3:** Pressing the SOURCE (ON) key, LCD displays “SAVE” symbol on the upper part for 1sec.

### **Tips:**

When the default value is 0, the backlight won't be off automatically if turned on except that you turn it off manually.

### **10.3 Setting temperature unit**

**Step 1:** Pressing the MEASURE (ON) key ,LCD displays “TEM.U” symbol on the upper part, indicating temperature unit setting mode.

**Step 2:** Shifting between the °C and °F by using the right pair of (▲) / (▼) .

**Step 3:** Pressing the SOURCE (ON) key, LCD displays “SAVE” symbol on the upper part for 1s.

### **10.4 Setting frequency**

**Step 1:** Pressing the MEASURE (ON) key ,LCD displays “FRSET” symbol on the upper part, indicating frequency setting mode.

**Step 2:** Shifting between the 50Hz and 60Hz by using the right pair of (▲) / (▼) .

**Step 3:** Pressing the SOURCE (ON) key, LCD displays “SAVE” symbol on the upper part for 1s.

### **10.5 Setting communication module for PCM(PC computer)、DPM(pressure module) or CAT(temperature module)**

**Step 1:** Pressing the measurement (ON) key ,LCD displays “CMSET” symbol on the upper part and “PCM” symbol on the lower part, indicating PC communication default.

**Step 2:** Shifting between the PCM(PC computer)、DPM(pressure module) and CAT(temperature module) by using the right pair of (▲) / (▼) .

**Step 3:** Pressing the source (ON) key, LCD displays “SAVE” symbol on the assistance district part for 1s.

### **10.6 Factory default**

**Step 1:** Pressing the MEASURE (ON) key ,LCD displays “FACRY” symbol on the upper part, indicating factory default.

**Step 2:** Pressing the SOURCE (ON) key, LCD displays “SAVE” symbol on the upper part for 1s. All settings are defaulted as below:

AP.OFF: 10min.

BL.OFF: 10sec.

TMP.U: °C.

FRSET: 50 Hz.

CMSET: PCM

**Tips:**

Any change of setting to the above-mentioned function, press the SOURCE (ON) key to save the value. Any press of the SOURCE (ON) key saves the nearest setting value.

## 11 Adjusting Measurement Functions

### Environmental Requirements

Ambient temperature: 23  $\pm$ 5°C

Relative humidity: 35% to 75% RH

Warm-up:

- Before using, warm up the calibrator for the period of time specified.
- Put the meter into the standard environment for 24 hours, and then turn on the power. Change the set into non-automatic power-off state and warm it up for one hour.

**Caution:**

Power Supply: new alkaline size (AAA) battery type 7 is the best choice for adjustment.

**Measurement Adjustment Operation**

Please undertake the **adjustment** following the sequence and points listed in Table 6.

Table 5 Adjustment Points of Measurement Functions

Range	Adjustment Point		Remarks
	0	FS	
DCV_50mV	-	75mV	
DCV_500mV	-	500mV	
DCV_5V	-	5V	
DCV_50V	-	50V	
DCmA_50mA	-	50mA	
OHM_500 $\Omega$	0 $\Omega$	500 $\Omega$	3W connection
OHM_5K $\Omega$	0 $\Omega$	5K $\Omega$	3W connection
FREQ_500Hz	-	500Hz	Plus 3V square wave

\* Applying reference input signals from the calibration standard as listed in the above table.

**Tips:**

- You can also select only the range in need of readjustment to adjust it separately.
- Always make zero-point (0) **adjustments** together with full-scale (FS) **adjustments**.

Turn on the meter; press the MEASURE (ON) key while simultaneously holding down the backlight ()key.

LCD shows “CAL” symbol on the upper top right corner and the measured value and unit on the upper part.

### Tips:

- If the battery level is below 25% full, the adjustment operation can't be operated. And the LCD shows “ERR” in the lower part.

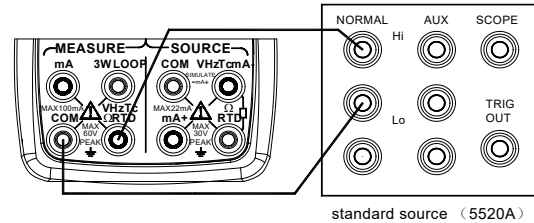

Figure 16 Calibrating DC voltage and frequency

## 11.1 Adjusting all ranges of the DC Voltage

**Step 1:** Make sure the lead cables for measurement are not connected to the measuring instrument under test.

**Step 2:** Using the function selector switch MEASURE ( **FUNC** ), select DC voltage function.

**Step 3:** Connect the lead cables to the output terminals of the standard source as shown in Figure 16.

**Step 4:** Pressing the ( **RANGE** ) key selects the range. The measured value and unit shall be shown in the upper part of the LCD.

**Step 5:** Pressing the ( **HOLD** ) key enters the measurement CAL mode. The LCD shows the present adjusting point “P.-0” in the lower part and the reference voltage and unit needed for the point in the upper part.

**Step 6:** Pressing the ( **LOOP** ) key saves the adjusted value and the LCD shows “SAVE” symbol in the upper part for 2 seconds.

**Step 7:** Pressing the ( **HOLD** ) key exits the CAL mode and back to step 4 for next range, until other range

adjustment is finished.

**Tips:**

- In the CAL mode, shifting to different functions leads to exit from the CAL mode directly.
- Adjustment to the DC voltage of 75mV range calibrates the TC temperature measurement range at the same time.

## 11.2 Adjusting Frequency

**Step 1:** Make sure the lead cables for measurement are not connected to the measuring instrument under test.

**Step 2:** Using the function selector switch MEASURE ( **FUNC** ) , select frequency function.

**Step 3:** Connect the lead cables to the output terminals of the standard source as shown in Figure 16.

**Step 4:** The measured value and unit shall be shown in the upper part of the LCD.

**Step 5:** Pressing the ( **HOLD** ) key enters the measurement CAL mode. The LCD shows the present adjusting point “P.-0” in the lower part and the reference frequency and unit needed for the point in the upper part.

**Step 6:** Pressing the ( **LOOP** ) key saves the adjusted value and the LCD shows “SAVE” symbol in the upper part for 2 seconds.

**Step 7:** Pressing the ( **HOLD** ) key exits the CAL mode. The adjustment is finished.

**Tips:**

In the CAL mode, shifting to different functions leads to exit from the CAL mode directly.

## 11.3 Adjusting 50mA DC Current

**Step 1:** Make sure the lead cables are not connected to the standard source.

**Step 2:** Using the function selector switch MEASURE ( **FUNC** ) , select DC current function.



**Step 3:** Connect the lead cables to the output terminals of the standard source as shown in Figure 17.

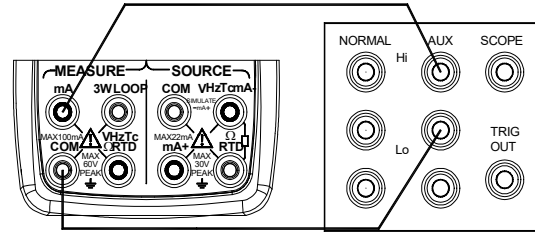

Figure 17 Calibrating DC current 50mA

**Step 4:** The measured value and unit shall be shown in the upper part of the LCD.

**Step 5:** Pressing the (HOLD) key enters the 20mA of DCmA CAL mode. The LCD shows the present adjusting point “P.-0” in the lower part and the reference current and unit needed for the point in the upper part.

**Step 6:** Pressing the (LOOP) key saves the adjusted value and the LCD shows “SAVE” symbol in the upper part for 2 seconds.

**Step 7:** Pressing the (HOLD) key exits the CAL mode. The adjustment is finished.

#### Tips:

In the CAL mode, shifting to different functions leads to exit from the CAL mode directly.

### 11.4 Adjusting all ranges of ohms

**Step 1:** Make sure the lead cables for measurement are not connected to the measuring instrument under test.

**Step 2:** Using the function selector switch MEASURE (FUNC) , select ohm function.

**Step 3:** Connect the lead cables to the output terminals of the standard source as shown in Figure 18.

**Step 4:** Pressing the (RANGE) key selects the range. The measured value and unit shall be shown in the upper part of the LCD.

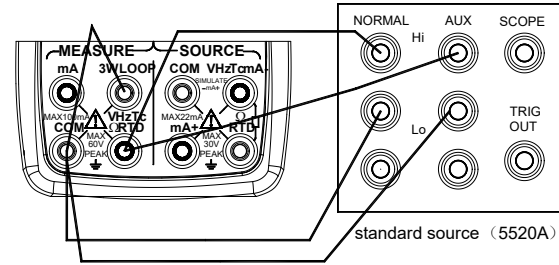

Figure 18 Adjusting all ranges of ohms

**Step 5:** Pressing the (HOLD) key enters the ohm CAL mode. The LCD shows the present adjusting point “P.-0” in the lower part and the reference resistance and unit needed for the point in the upper part.

**Step 6:** Pressing the (LOOP) key saves the adjusted value and the LCD shows “SAVE” symbol in the upper part for 2 seconds.

**Step 7:** Pressing the (AVG) key causes the adjusting point shifting between P.-0 and P.-F. The LCD shows the reference resistance and unit needed for the point in the upper part.

**Step 8:** Pressing the (LOOP) key saves the adjusted value and the LCD shows “SAVE” symbol in the upper part for 2 seconds.

**Step 9:** Pressing the (HOLD) key exits the CAL mode and back to step 4. Undertaking the next range by pressing the (RANGE) key and repeating from step 5 to step 8 until all ranges have been adjusted.

**Caution:**

- The material and length of the leads connected both to COM terminal and VHzTcΩRTD terminals should be the same.
- Make sure the previous adjusting point has been saved before shifting to another one.

**Tips:**

- In the CAL mode, shifting to different functions leads to exit from the CAL mode directly.
- Adjustment to the ohms calibrates the RTD temperature measurement range at the same time.

## 12 Adjusting Source Functions

### Environmental Requirements

Ambient temperature: 23 ±2°C

Relative humidity: 35% to 75% RH

Warm-up:

- Before using, warm up the calibrator for the period of time specified.
- Set the meter into the standard environment for 24 hours, and then turn on the power. Change the set into non-automatic power-off state and warm it up for one hour.

Power Supply: new alkaline size (AAA) battery type 7 is the best choice for adjustment.

Source Adjustment Operation:

Table 6 Adjustment Points of Source Functions

Range	Adjustment Point *					Remarks
	0	F	FS	-0	-F	
DCV_100mV	0	100mV	/	/	/	

DCV_1V	0	0	1V	/	/	
DCV_10V	0	10V	/	/	/	
DCmA_20mA	0	20mA	/	/	/	
OHM_400 Ω /1mA	0 Ω	400 Ω	/	-0 Ω	-400 Ω	I=± 1mA
OHM_400 Ω /0.1mA	0 Ω	400 Ω	/	-0 Ω	-400 Ω	I=±0. 1mA
OHM_4K Ω /0.1mA	0 Ω	4K Ω	/	-0 Ω	-4K Ω	I=±0. 1mA
OHM_40K Ω /0.01mA	0 Ω	40K Ω	/	-0 Ω	-40K Ω	I=±0. 01mA

\* Adjusting the displayed value same with the reading of the digit meter when the present calibrator is stabilized.

- You can calibrate a desired function and range separately.
- You must calibrate all the calibrating points of the selected range together.
- When adjusting resistance source, the exciting current is (+) for adjustment point "0" and "F", and is (-) for adjustment point "-0" and "-F".

Turn on the meter; press the (ON) key while simultaneously holding down the backlight (☀)key enters the source calibration state. LCD shows “CAL” symbol on the upper part, the present calibrating point on the top right corner and the high 5 digits of the responding value and its unit on the lower part. The digit in the right on the upper part is the lowest digit of the value.

Tips:

If the battery level is below 25% full, the adjustment operation can't be operated. And the LCD shows "ERR" in the lower part.

## 12.1 Adjusting Voltage Source

**Step 1:** Using the function selector switch SOURCE (FUNC) , select DC voltage function. Connect the lead cables for measurement to the standard digital meter as shown in Figure 19.

**Step 2:** Pressing the (RANGE) key selects the right range.

**Step 3:** The LCD shows “0” symbol on the top right corner and the calibrator is ready for the zero-point adjustment of source functions. The LCD shows the highest five digits and its unit in the lower part and the lowest digit of the calibrated sourced value in the right of the upper part respectively.

**Step 4:** Read the calibrator output on the calibration standard. Then, using the pair of (▲) / (▼) keys, adjust the reading so that it matches the measured CAL adjustment setpoint. In the CAL mode, the right pair of (▲) / (▼) keys are used to increase or decrease the least-significant digit, including the auxiliary digit(the digit in the right of the upper LCD part).

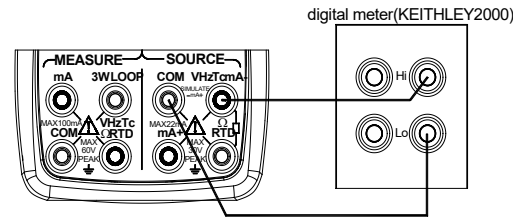

Figure 19 Adjusting voltage source

**Step 5:** Press the (MTR) key to save the CAL adjustment reading .

**Step 6:** Pressing the (START) key shifts to the next setpoint.

**Step 7:** The LCD shows the calibrated setpoint symbol on the top right corner. The LCD shows the highest five digits and its unit in the lower part and the lowest digit of the calibrated sourced value in the right of the upper part respectively.

**Step 8:** Read the calibrator output on the calibration standard. Then, using the pair of (▲) / (▼) keys, adjust the reading so that it matches the measured CAL adjustment setpoint.

**Step 9:** Pressing the (MTR) key once again saves the CAL adjustment reading.

**Step 10:** Pressing the (START) key, you can adjust all the adjustment point assigned to that range by repeating steps 6 to 9.

**Step 11:** By repeating steps 2 to 10, you can adjust all ranges of the DC voltage source function.

**Note:**

- Adjustment to the 100mV range calibrates the TC temperature measurement range at the same time.
- Make sure the previous adjusting point has been saved before shifting to another one.

## 12.2 Adjusting Current Source

**step 1:** Using the function selector switch SOURCE (FUNC) , select DC current function. Connect the

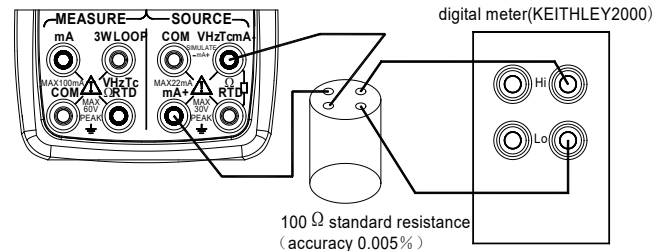

Figure 20 Adjusting current source

lead cables for measurement to the standard digital meter as shown in Figure 20.

**Step 2:** The LCD shows “0” symbol on the top right corner and the calibrator is ready for the zero-point adjustment of source functions. The LCD shows the highest five digits and its unit in the lower part and the lowest digit of the calibrated sourced value in the right of the upper part respectively.

**Step 3:** Read the calibrator output on the calibration standard. Then, using the pair of (▲) / (▼) keys, adjust the reading so that it matches the measured CAL adjustment setpoint. In the CAL mode, the right pair of (▲) / (▼) keys are used to increase or decrease the least-significant digit, including the auxiliary digit (the digit in the right of the upper LCD part).

**Step 4:** Press the (M<sup>+</sup>) key to save the CAL adjustment reading .

**Step 5:** Pressing the (START) key shifts to the next setpoint.

**Step 6:** The LCD shows the calibrated setpoint symbol on the top right corner. The LCD shows the highest five digits and its unit in the lower part and the lowest digit of the calibrated sourced value in the right of the upper part respectively.

**Step 7:** Read the calibrator output on the calibration standard. Then, using the pair of (▲) / (▼) keys, adjust the reading so that it matches the measured CAL adjustment setpoint.

**Step 8:** Pressing the (M<sup>+</sup>) key once again saves the CAL adjustment reading.

**Step 9:** Pressing the (START) key, you can adjust all the adjustment point assigned to that range by repeating steps 6 to 8.

Note:

Make sure the previous adjusting point has been saved before shifting to another one.

## 12.3 Adjusting Resistance Source

**Step 1:** Using the function selector switch SOURCE (FUNC), select resistance function. Connect the lead cables for measurement to the standard digital meter as shown in Figure 21.

**Step 2:** Pressing the (RANGE) key selects the right range.

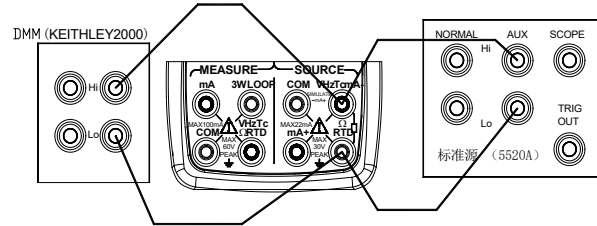

Figure 21 Adjusting resistance source

**Step 3:** The LCD shows “0” symbol on the top right corner and the calibrator is ready for the zero-point adjustment of source functions. The LCD shows the highest five digits and its unit in the lower part and the lowest digit of the calibrated sourced value in the right of the upper part respectively.

**Step 4:** Read the calibrator output on the calibration standard. Then, using the pair of (▲) / (▼) keys, adjust the reading so that it matches the measured CAL adjustment setpoint. In the CAL mode, the right pair of (▲) / (▼) keys are used to increase or decrease the least-significant digit, including the auxiliary digit (the digit in the right of the upper LCD part).

**Step 5:** Press the (MTR) key to save the CAL adjustment reading.

**Step 6:** Pressing the (START) key shifts to the next setpoint.

**Step 7:** The LCD shows the calibrated setpoint symbol on the top right corner. The LCD shows the highest five digits and its unit in the lower part and the lowest digit of the calibrated sourced value in the right of the upper part respectively.



**Step 8:** Read the calibrator output on the calibration standard. Then, using the pair of (▲) / (▼) keys, adjust the reading so that it matches the measured CAL adjustment setpoint.

**Step 9:** Pressing the (M<sub>RT</sub>) key once again saves the CAL adjustment reading.

**Step 10:** Pressing the (START) key, you can adjust all the adjustment point assigned to that range by repeating steps 6 to 9.

**Step 11:** By repeating steps 2 to 10, you can adjust all ranges of the resistance source function.

**Note:**

- In ohm calibration function, you can differentiate the negative exciting calibration from the left “-” mark on the lower part. The value of the exciting current is indicated by the digit on the top right corner.(unit :mA)
- Make sure to preserve the calibrating value before changing the calibrating point or range. Otherwise, the previous reading won't be saved if the point or range is changed.
- Calibration of the ohm 400 Ω and ohm 4K Ω means calibrating all ranges of the RTD.
- In 400 Ω range resistance calibration:

1) Adjusting of inner variance

Make sure the applied voltage between the H and L terminals is within  $\pm 20$  uV, when setting 0.00 Ω resistance. If the voltage exceeds the range, the calibrator needs internal adjustment, then contact the vendor from whom you purchased the calibrator.

2) Noting exciting current of sourcing resistance

Calibration of the 400 Ω resistance range requires 2 exciting currents of 0.1mA and 1mA from external devices, of which the range is calibrated respectively.

## 13 Replacing Batteries or fuse:

### ⚠Warning

To avoid possible electric shock, remove the test leads from the calibrator before open the battery door. And make sure the battery door is tightly closed before turning on the calibrator.

### Caution

- To avoid possible linkage of the liquid and explosion of the battery, make sure to place the battery with right polarity.
- Do not operate the battery in short-circuit.
- Do not disassemble or heating the battery or throw them into the fire
- When replacing, use only four same specified ones.

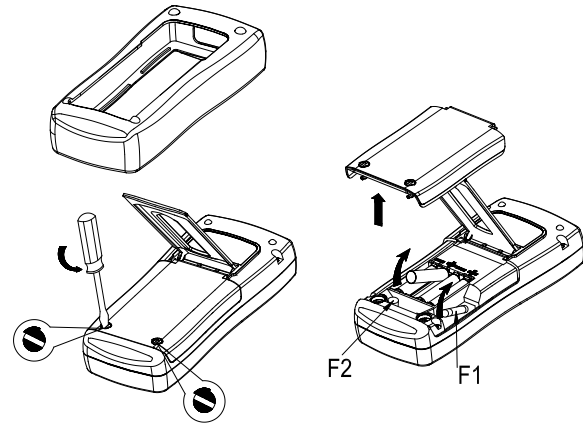

Figure 22 Replacing batteries and fuses

- Take out the battery if you don't operate the meter for a long time.

**Step 1:** Remove the test leads and Charger before replacing batteries or fuse, and turn off the meter.

**Step 2:** Remove the protector as shown in Figure 22. With a standard blade hand screwdriver, turn each battery door screw a quarter counterclockwise to remove the battery door.

**Step 3:** Replace with four new AAA alkaline batteries under the instructions shown on the battery door. Or

replace the blown fuses with same type [F1 \(63mA/250V\)](#) or [F2 \(50mA/250V\)](#).

**Step 4:**Reinstall and tighten the battery door, put on the protector before using the meter.

## 14 How to use the charger

### Warning

- The charger could be used only to specified product.
- Make sure the voltage of the AC power is same with the given voltage of the charger before connecting them.
- Do not shut circuit the output plug of the charger.
- Do not charge non-Ni-Cd, non-Ni-MH battery or wasted battery.

**Step 1:**Turn off the calibrator.

**Step 2:**Connect the plug into the charging jack of the terminal.

**Step 3:**Plug the charger into the AC power.

### **Note:**

In normal charging function, the indicating light of the charger lights on.

When finished, the charging function stops automatically, and the indicating light becomes dark.

Blinking of the indicating light means the charger is not connected or no battery is inside.

### **Note:**

Do not use the calibrator when it undergoes charging, otherwise, the charging will be prolonged.

# 15 Maintenance

## 15.1 cleaning the calibrator

### Warning

To avoid electrical shock or damaging the meter, serve the meter only by the replacement parts specified and never get water inside the case.

### **Caution**

To avoid damaging the plastic lens and case, do not use solvents or abrasive cleansers.

Clean the Calibrator with a soft cloth dampened with water or water and mild soap.

## 15.2 Calibration or Sending to the Service Center

Calibration, maintenance or repair work unmentioned in this manual should be undertaken by the experienced worker. If the meter operates abnormally, inspect the batteries first and replace them if necessary.

If you suspect that the meter has failed, review this manual to make sure you are operating it correctly. If the meter still fails to operate properly, pack it securely (in its original container if available) and forward it, postage paid, to the nearest Service Center. The company assumes NO responsibility for damage in transit.

The Company guarantees a rapid repair and maintenance and delivers the meter back as soon as possible. Please refer to the Warranty. If the warranty is due, you will be billed for the maintenance and repair work. If the calibrator or the pressure module is not within the Warranty range, you can contact the warranted service center for enquiring about the expenditure. Please refer to the Chapter “Contact Us” to find a warranted service center.

## 15.3 Replacement of Parts

All the types of parts are listed in Table 8, see Figure 23 as reference.

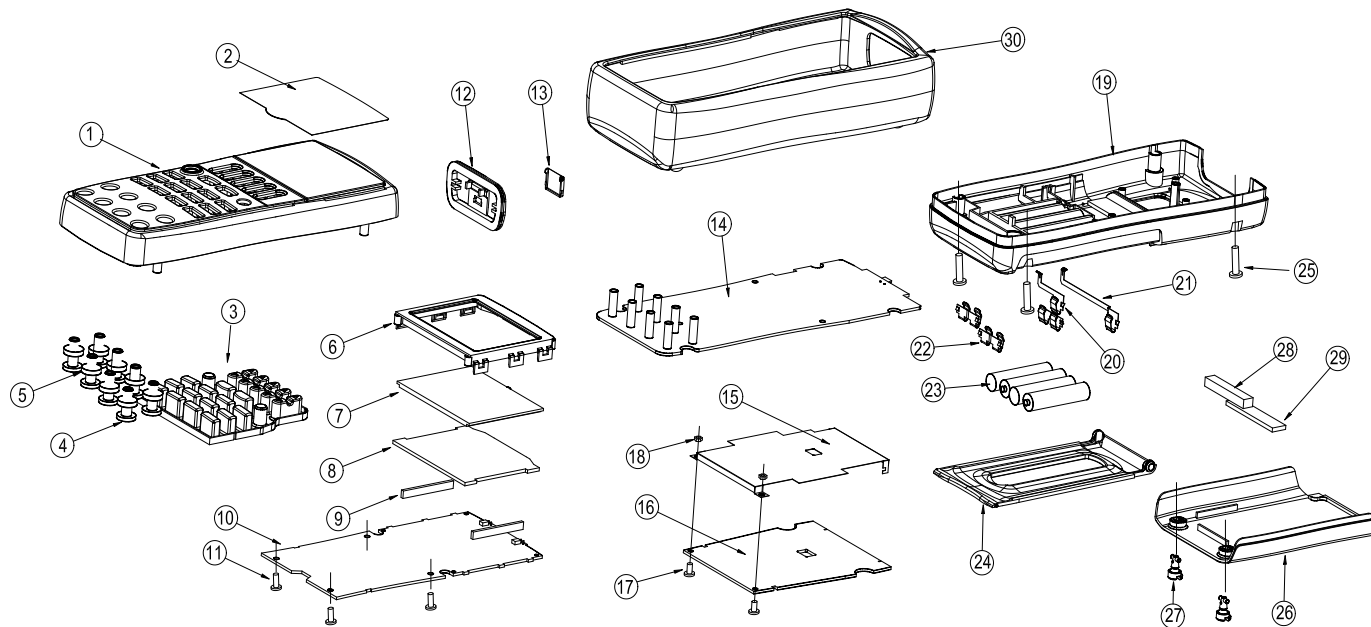

Figure 23. Replacing part

Table 7. Replacing parts

Item	Instruction	Quantity	Item	Instruction	Quantity
1	Top panel	1	17	Screw M3*6	2
2	plastic lens	1	18	Nut M3	2
3	Rubber Key	1	19	Bottom Panel	1
4	Terminal Wrapper	4	20	Spring A	1
5	Terminal Gasket	4	21	Spring B	1
6	LCD Frame	1	22	Spring C	3
7	LCD	1	23	AAA Alkaline battery	4
8	Backlight Panel	1	24	Tilt-stand	1
9	Conductive Rubber wire	2	25	Screw M3*16	4
10	LCD Circuit Panel	1	26	Battery Door	1
11	Screw M3*8	4	27	Plastic Screw	2
12	Terminal Cover	1	28	Sponge: length × width × height = 40 × 6 × 6	1
13	Cover Door	1	29	Sponge: length × width × height = 48 × 10 × 2.5	1
14	Main Circuit Panel	1	30	Outer Protector	1
15	Power Panel Shield	1			
16	Power circuit Panel	1			

# 16 Options

For more information about the options (see Figure 24) and its price, please contact the representative of the company. For information about relevant pressure module and its type (see Table 9 and Table 10). For information about the new pressure module, which isn't listed in Table 10, please contact the representative of the company.

Table 8 Options

No.	Name of the Options	Mode
1	CALCP Pressure module convertor	P070104-10
2	CALCT Temperature Probe	P070201-00
3	TC Plug	R/S/K/E/J/T/N /B
4	Thermocouple Convertor	H200000-00
5	Test Hoop	H000004-00
6	CA Charger	P070002-00
7	CA portable DC power supply	P070004-00
8	CA communication convert module	P070103-00

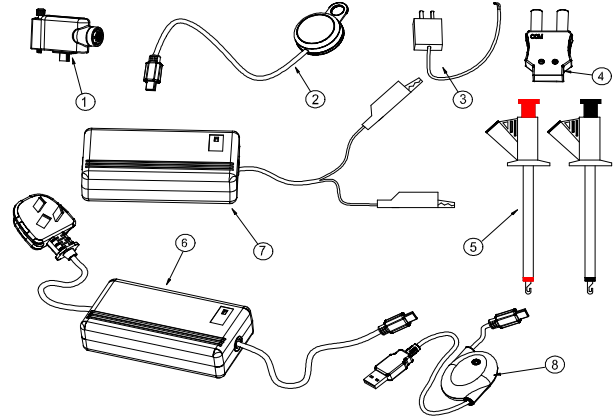

Figure 24 Options

## 16.1 CALCP Pressure module convertor (P070104-10)

**Step 1:** According to chapat10.5 to set “CMSET: DPM”.

**Step 2:** Plug the MINI\_USB of the CALCP Pressure module convertor into the USB port on the instrument, and fasten the CALCP Pressure module convertor by turn the nut clockwise.

**Step 3:** connect the jack of the pressure module with the LEMO jack of the CALCP Pressure module convertor.

**Step 4:** Measure or source pressure according to chapter 7.10 or 8.10.

### Note:

- Connect the CALCP Pressure module convertor with the instrument before power on the instrument. “ERR.MD” will be displayed on the display of the instrument if the connection failed. There will be no other displays if the connection succeeds.

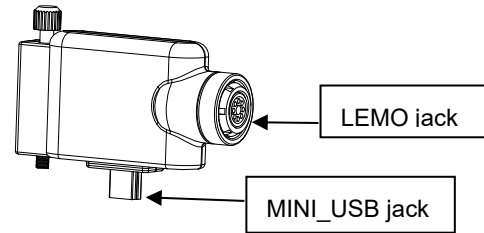

Figure 25 CALCP Pressure module convertor

- Connect the CALCP Pressure module convertor with the instrument after power on the instrument or connect the CALCP Pressure module convertor with the instrument in use newly, the instrument will display “NO\_OP” at pressure function.
- About the specifications and requires of the CALCP Pressure module convertor refer to the “user manual for calibrator options”.

## 16.2 CALCT Temperature Probe (P070201-00)

**Step 1:** According to chapat10.5 to set “CMSET: CAT”.



**Step 2:** Plug the MINI\_USB sock of the CALCT into the USB port on the instrument.

**Step 3:** Put the flake aluminium of the CALCT close to the measured object and holding for 10 minutes.

**Step 4:** Measure or source TC according to chapter 7.5 or 8.5

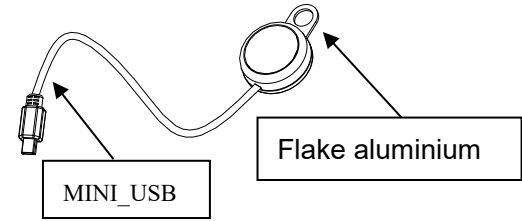

Figure 26 CALCT Temperature Probe

**Note:**

- Connect the temperature probe with the instrument before power on the instrument. “ERR.MD” will be displayed on the display of the instrument if the connection failed. There will be no other displays if the connection succeeds, then the temperature probe will be work normally. If the communication failed in use, the measurement will be stopped and the measurement value displayed on the display will be 0, then the internal temperature module will be work after 3 seconds.
- Connect the temperature probe with the instrument after power on the instrument or connect the temperature probe with the instrument in use newly, the temperature will not be work.
- About the specifications and requires of the temperature probe refer to the “user manual for calibrator options”.

**16.3 CA Charger (P070002-00)**

**Step 1:** Power off the instrument.

**Step 2:** Connect the CA charger with a power line.

**Step 3:** Plug the MINI\_USB sock of the CA charger into the USB port on the instrument.

**Step 4:** Connect with the power supply, begin charge.

**Note:**

- Power off the instrument when charging
- The charge lamp lighted when charging; the charge lamp dark when charge full; the charge lamp flicker when nonloaded.
- About the specifications and requires of the AC charger refer to the “user manual for calibrator options”.

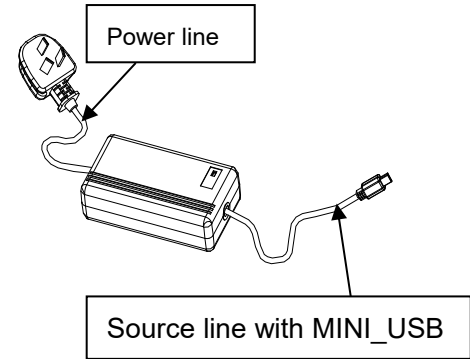

Figure 27 CA charger

#### 16.4 CA portable DC power supply (P070004-00)

**Step 1:** Connect the 24V DC Power Supply with the instrument according to figure 28.

**Step 2:** Move the DC Power Supply switch to the “ON” position, the indicator light light and supply power to the instrument.

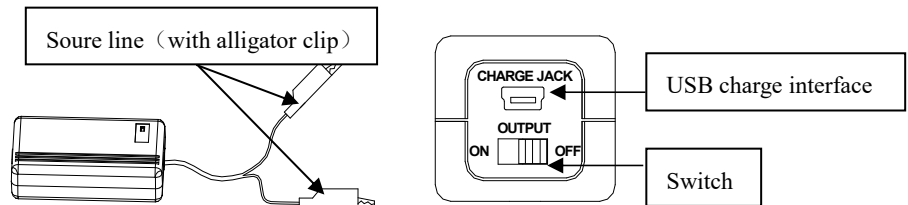

Figure 28 CA portable DC power supply

**Note:**

- The indicator light lighted indicates the DC Power Supply works normally; the indicator light dark, indicates the DC Power Supply over loading, cut off the load and inspect the load whether short circuit.
- Don't supply power to the instrument when charge the CA portable DC power supply.
- About the specifications and requires of the CA portable DC power supply refer to the “user manual for calibrator options”.

**16.5 CA communication convert module (P070103-00)**

**Step 1:** According to chapat10.5 to set “CMSET: PCM”.

**Step 2:** Connect the IR\_METER sock on the CA communication convert module with the USB port on the instrument.

**Step 3:** Connect the PC\_IR sock with PC, the indicator light lighted.

**Step 4:** Use the computer to control the instrument according to the instrument's communication agreement.

**Note:**

About the specifications and requires of the AC communication convert module refer to the “user manual for calibrator options”.

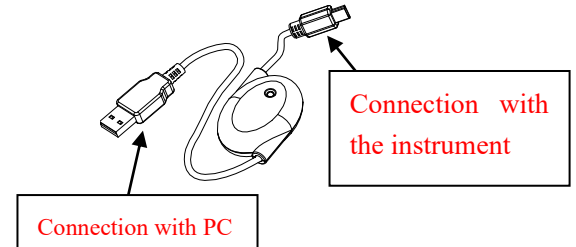

Figure 29 CA Communication Convert Module

## 17 Specifications and Capacitance of External Pressure Module

The pressure module output can possibly cause overflow the five digits of LCD. Or when choosing an unsuitable unit, the value cannot be read due to smallness. LCD displays OL (overload) if the reading exceeds those range listed in the following table.

Table 9. Technical Index of Pressure Model

Type, range and accuracy of pressure module						
Type of module	Range (kPa)	bar (bar)	psi (psi)	type of sensor	pressure datum	Overall accuracy (%) 0~50℃
<b>VPM100KGS</b>	0~100kPa	0~1bar	0~15psi	Isolated, 316 stainless steel	gauge pressure	0.05
<b>VPM200KGS</b>	0~200kPa	0~2bar	0~30psi	Isolated, 316 stainless steel	gauge pressure	0.05
<b>VPM500KGS</b>	0~500kPa	0~5bar	0~72psi	Isolated, 316 stainless steel	gauge pressure	0.05
<b>VPM001MGS</b>	0~1MPa	0~10bar	0~150psi	Isolated, 316 stainless steel	gauge	0.05

					pressure	
<b>VPM002MGS</b>	0~2MPa	0~20bar	0~300psi	Isolated, 316 stainless steel	gauge pressure	0.05
<b>VPM005MGS</b>	0~5MPa	0~50bar	0~725psi	Isolated, 316 stainless steel	gauge pressure	0.05
<b>VPM010MGS</b>	0~10MPa	0~100bar	0~1500psi	Isolated, 316 stainless steel	sealed gage pressure	0.05
<b>VPM020MGS</b>	0~20MPa	0~200bar	0~3000psi	Isolated, 316 stainless steel	sealed gage pressure	0.05
<b>VPM040MGS</b>	0~40MPa	0~400bar	0~5800psi	Isolated, 316 stainless steel	sealed gage pressure	0.05
<b>VPM060MGS</b>	0~60MPa	0~600bar	0~8700psi	Isolated, 316 stainless steel	sealed gage	0.05

					pressure	
<b>VPM100KAS</b>	0~100kPa	0~1bar	0~15psi	Isolated, 316 stainless steel	Absolute pressure	0.05
<b>VPM200KAS</b>	0~200kPa	0~2bar	0~30psi	Isolated, 316 stainless steel	Absolute pressure	0.05
<b>VPM500KAS</b>	0~500kPa	0~5bar	0~72psi	Isolated, 316 stainless steel	Absolute pressure	0.05
<b>VPM001MAS</b>	0~1MPa	0~10bar	0~150psi	Isolated, 316 stainless steel	Absolute pressure	0.05
<b>VPM002MAS</b>	0~2MPa	0~20bar	0~300psi	Isolated, 316 stainless steel	Absolute pressure	0.05
<b>VPM005MAS</b>	0~5MPa	0~50bar	0~725psi	Isolated, 316 stainless steel	Absolute pressure	0.05
<b>VPM010MAS</b>	0~10MPa	0~100bar	0~1500psi	Isolated, 316 stainless steel	Absolute pressure	0.05
<b>VPM020MAS</b>	0~20MPa	0~200bar	0~3000psi	Isolated, 316 stainless steel	Absolute pressure	0.05

				stainless steel	pressure	
<b>VPM100KCS</b>	-100~ 100KPa	-1~1bar	-15~15psi	Isolated, 316 stainless steel	compound pressure	0.05
<b>VPM200KCS</b>	-100~ 200KPa	-1~2bar	-15~30psi	Isolated, 316 stainless steel	compound pressure	0.05
<b>VPM500KCS</b>	-100~ 500KPa	-1~5bar	-15~72psi	Isolated, 316 stainless steel	compound pressure	0.05
<b>VPM001MCS</b>	-0.1~1MPa	-1~10bar	-15~150psi	Isolated, 316 stainless steel	compound pressure	0.05
<b>VPM002MCS</b>	-0.1~2MPa	-1~20bar	-15~300psi	Isolated, 316 stainless steel	compound pressure	0.05

***note:***

1. pressure datum: gauge pressure, absolute pressure and compound pressure
2. pressure unit: supporting varieties of pressure unit(take calibrator main frame as reference)
3. resolution: 5 digits
4. measurement media: varieties of liquid and gas of 316 stainless steel are compatible

5. working temperature: 0 to 50°C
6. storage temperature: -10 to 60°C
7. sealed grade: IP54
8. pressure connector: M20×1.5mm external thread
9. module electronic connector: Binder 5-pole male
10. communication cable(option): Binder 5-pole female to LEMO 5-pole male。
11. comply with electromagnetic standards (EMC) : EN61326-1: 2006
12. comply with electromagnetic standards: IEC 61010-1: 2000
13. measurement: about Ø30×130mm
14. weight: about 350g

## 18 Specifications

General Specifications for measure

These specifications assume:

- A 1-year calibration cycle
- An operating temperature of 18°C to 28°C
- Relative humidity of 35% to 70% (non\_condensing)



Accuracy is expressed as  $\pm$  (percentage of reading + percentage of range).

Function	Reference	Range	Resolution	Accuracy	Remark
DCV	50mV	-5.000mV~ 55.000mV	1 $\mu$ V	0.02+0.02	Input Resistance: 100M $\Omega$
	500mV	-50.00mV~ 550.00mV	10 $\mu$ V	0.02+0.01	
	5V	-0.5000V~ 5.5000V	0.1mV	0.02+0.01	Input Resistance: 1M $\Omega$
	50V	-5.000V~ 55.000V	1mV	0.03+0.01	
DCmA	50mA	-5.000mA~ 55.000mA	1 $\mu$ A	0.02+0.01	Shunt Resistance: 10 $\Omega$
OHM	500 $\Omega$ Test Current: Approximate ly 1mA	0.00 $\Omega$ ~ 550.00 $\Omega$	0.01 $\Omega$	0.05+0.02	Open Circuit Voltage: about 2.5V; Does not include lead resistance;

	5K $\Omega$ Test Current: Approximate ly 0.1mA	0.0000 K $\Omega$ ~ 5.5000K $\Omega$	0.1 $\Omega$	0.05+0.02	
FREQ	500Hz	3Hz~500.00Hz	0.01Hz	$\pm 2$ digit	Input Impedance: 100 k $\Omega$ at least; Sensitivity: 3Vp-p minimum; Duty Cycle: 50%.
	5KHz	3Hz~ 5.0000KHz	0.1Hz		
	50KHz	3Hz ~ 50.000KHz	1Hz		
TC	R	0 $^{\circ}$ C~1767 $^{\circ}$ C	1 $^{\circ}$ C	0~500 $^{\circ}$ C : 1.8 $^{\circ}$ C	By using ITS-90 temperature scale; The accuracy does not include the error of internal temperature compensation caused by a sensor;
	S	0 $^{\circ}$ C~1767 $^{\circ}$ C		500~1767 $^{\circ}$ C : 1.5 $^{\circ}$ C	
	K	-100.0 $^{\circ}$ C ~ 1372.0 $^{\circ}$ C	0.1 $^{\circ}$ C	-100.0~0.0 $^{\circ}$ C : 1.2 $^{\circ}$ C 0.0~1372.0 $^{\circ}$ C : 0.8 $^{\circ}$ C	
	E	-50.0 $^{\circ}$ C ~ 1000.0 $^{\circ}$ C		-50.0 $^{\circ}$ C~0.0 $^{\circ}$ C : 0.9 $^{\circ}$ C 0.0~1000.0 $^{\circ}$ C: 1.5 $^{\circ}$ C	

	J	-60.0 ° C ~ 1200.0°C		-60.0~0.0°C : 1.0°C 0.0~1200.0°C : 0.7°C	
	T	-100.0 ° C ~ 400.0°C		-100.0~0.0°C : 1.0°C 0.0~400.0°C : 0.7°C	
	N	-200.0 ° ~ 1300.0°C		-200.0~0.0°C : 1.5°C 0.0~1300.0°C : 0.9°C	
	B	600°C~1820°C	1°C	600~800°C : 2.2°C 800~1000°C : 1.8°C 1000~1820°C: 1.4°C	
RTD	Pt100 385	-200.0 ° C ~ 800.0°C	0.1°C	-200.0~0.0°C : 0.5°C 0.0~400.0°C : 0.7°C 400.0~800.0°C : 0.8°C	By using Pt100-385 Does not include lead resistance.
	Pt1000 385	-200.0 ° C ~ 630.0°C		-200.0~100.0°C: 0.3°C 100.0~300.0°C : 0.5°C 300.0~630.0°C : 0.7°C	

	Pt200 385	-200.0 ° C ~ 630.0°C		-200.0~100.0°C : 0.8°C 100.0~300.0°C : 0.9°C 300.0~630.0°C : 1.0°C	
	Pt500 385	-200.0 ° C ~ 630.0°C		-200.0~100.0°C : 0.4°C 100.0~300.0°C : 0.5°C 300.0~630.0°C : 0.7°C	
	Cu10	-100.0 ° C ~ 260.0°C		1.8°C	
	Cu50	-50.0 ° C ~ 150.0°C		0.7°C	
SWITCH		CLOSE / OPEN			Approximately 1mA Test Current Short circuit display : CLOSE, Open circuit display: OPEN; Threshold value about 200~300Ω

CONT.	500Ω	≤50Ω sound			Approximately 1mA Test Current
-------	------	------------	--	--	--------------------------------

Other feature:

- Rate:

Measurement function	Rate
DCV、DCI、OHM、TC	2 Readings per Second about
RTD	1 Readings per Second about
FREQ	0.5 Readings per Second about
CONT.	4 Readings per Second about
PRESSURE	1.5 Readings per Second about

- DCV

Normal Mode Rejection Ratio (NMRR) ≥60dB (at 50Hz or 60Hz)

Common Mode Rejection Ratio (CMRR) ≥140dB (at 50Hz or 60Hz)

- Temperature Coefficient: 0.1 times the applicable accuracy specification per degree C for 5°C to 18°C and 28°C to 40°C
- The range of the internal temperature compensation sensor is from -10°C to 50°C, compensation error ≤0.5°C
- Maximum voltage between V<sub>Ω</sub> Hz terminal and COM terminal: 60 Vpk

Maximum Input current: 60mA.

Protected with a 63mA, 250V fast blow fuse

### General Specifications for Source

These specifications assume:

A 1-year calibration cycle

An operating temperature of 18°C to 28°C (64.4°F~82.4°F)

Relative humidity of 35% to 70% (non\_condensing)

Accuracy is expressed as  $\pm$  (percentage of set value + percentage of range)

Function	Reference	Range	Resolution	Accuracy	Remark
DC voltage	100mV	-10.000mV ~ 110.000mV	1 $\mu$ V	0.02+0.01	Maximum output current: 0.5mA
	1V	-0.10000V ~ 1.10000V	10 $\mu$ V	0.02+0.01	Maximum output current: 2mA

	10V	-1.0000V ~ 11.0000V	0.1mV	0.02+0.01	Maximum output current: 5mA
DC current	20mA	0.000mA ~ 22.000mA	1μA	0.02+0.02	External supply for simulate mA: 5V–28V Maximum load 1KΩ at 20mA
Resistance	400Ω	0.00Ω ~ 400.00Ω	0.01Ω	0.02+0.02	Excitation current: ± 0.5–3 mA; if ± 0.1–0.5, add 0.1Ω; Accuracy does not include lead resistance;
	4KΩ	0.0000 KΩ ~ 4.0000 KΩ	0.1Ω	0.05+0.025	Excitation current: ±0.05 –0.3mA; Does not include lead resistance;
	40KΩ	0.000 KΩ ~ 40.000 KΩ	1Ω	0.1+0.1	Excitation current: ±0.01mA; Does not include lead resistance;
TC	R	0°C~1767°C	1°C	0~100°C : 1.5°C 100~1767°C: 1.2°C	By using ITS-90 temperature scale;
	S	0°C~1767°C		0~100°C : 1.5°C 100~1767°C: 1.2°C	The accuracy does not include the error of internal temperature

	K	-200.0°C~1372.0°C	0.1°C	-200.0~-100.0 : 0.6°C -100.0~400.0°C:0.5°C 400.0~1200.0°C: 0.7°C 1200.0~1372.0 :0.9°C	compensation caused by a sensor;
	E	-200.0°C~1000.0°C		-200.0~-100.0 : 0.6°C -100.0~600.0°C:0.5°C 600.0~1000.0°C: 0.4°C	
	J	-200.0°C~1200°C		-200.0~-100.0 : 0.6°C -100.0~800.0°C:0.5°C 800.0~1200.0°C: 0.7°C	
	T	-250.0°C~400.0°C		-250.0~400.0°C: 0.6°C	
	N	-200.0°C~1300.0°C		-200.0~-100.0°C:1.0°C -100.0~900.0°C:0.7°C 900.0~1300.0°C:0.8°C	
	B	600°C~1820°C		1°C	
RTD	Pt100-385	-200.0 ° C ~ 800.0°C	0.1°C	-200.0~0.0°C : 0.3°C 0.0~400.0°C : 0.5°C 400.0~800.0°C: 0.8°C	By using Pt100-385 Excitation current: ±0.5~±3mA for Pt100, Cu10, Cu50;



	Pt200-385	-200.0 ° C ~ 630.0°C		-200.0~100.0°C : 0.8°C 100.0~300.0°C : 0.9°C 300.0~630.0°C : 1.0°C	Excitation current: ±0.05mA ~ ±0.3mA for PT200, PT500, PT1000; Does not include lead resistance.
	Pt500-385	-200.0 ° C ~ 630.0°C		-200.0~100.0°C : 0.4°C 100.0~300.0°C : 0.5°C 300.0~630.0°C : 0.7°C	
	Pt1000-385	-200.0 ° C ~ 630.0°C		-200.0~100.0°C : 0.2°C 100.0~300.0°C : 0.5°C 300.0~630.0°C : 0.7°C	
	Cu10	-100.0 ° C ~ 260.0°C		-100.0~260.0°C : 1.8°C	
	Cu50	-50.0 ° C ~ 150.0°C		-50.0~150.0°C : 0.6°C	
FREQ	100Hz	1.00Hz ~ 110.00Hz	0.01Hz	±2 count	Output voltage: +1~+11 V <sub>p-p</sub> (zero base waveform); Amplitude accuracy: ±(5% +0.5V);
	1KHz	0.100KHz ~ 1.100KHz	1Hz		

	10KHz	1.0KHz ~ 11.0KHz	0.1KH z		Maximum load: >100 KΩ; Duty Cycle: 50%.
	100KHz	1KHz ~ 110KHz	2KHz	±5 count	
PULSE	100Hz	1 ~ 100000cycles	1cyc	±2 count	
	1KHz				
	10KHz				
SWITCH	100Hz	1.00Hz ~ 110.00Hz	0.01Hz	±2 count	FET switch Maximum open/close voltage: +28 V Maximum open/close current:: 50mA
	1KHz	0.100KHz ~ 1.100KHz	1Hz		
	10KHz	1.0KHz ~ 11.0KHz	0.1KH z		
	100KHz	10KHz ~ 110KHz	2KHz	±5 count	
LOOP	24V			± 10%	Maximum current: 22 mA Short circuit protected

### Measurement and source pressure

	Rang and Accuracy	resolution	For more detail, refer the pressure
--	-------------------	------------	-------------------------------------

PRESSURE	Determined by pressure module	5 digits	module about APM.
----------	-------------------------------	----------	-------------------

Other feature:

- Temperature Coefficient: 0.1 times the applicable accuracy specification per degree C for 5°C to 18°C and 28°C to 40°C.
- The range of the internal temperature compensation sensor is from -10°C to 50°C  
Maximum voltage between any output terminal and earth: 30Vpk  
Maximum output current: Approximately 25mA.

## 19 Points for Attention to Use of Operation Instruction

- The present operation instruction is subject to change without notice.
- The content of the operation instruction is regarded as correct. Whenever any user finds its mistakes, omission, etc, he or she is requested to contact the manufacturer.
- The present manufacturer is not liable for any accident and hazard arising from any maoperation.
- The functions described in this operation instruction should not be used as grounds to apply this product to a particular purpose.