

FT-0310 Professional WIFI Weather Station User Manual

1.Introduction

Thank you for your purchase of the FT0310 Professional WIFI Wireless Weather station. The following user guide provides step by step instructions for installation, operation, and troubleshooting.

2.Warnings

⚠ Warning: Any metal object may attract a lightning strike, including your weather station mounting pole. Never install the weather station in a storm.



⚠ Warning: Installing your weather station in a high location may result in injury or death. Perform as much of the initial check out and operation.



3.Getting Started

The FT0310 weather station consists of a display console (receiver), a sensor array with Integrated Outdoor Transmitter and mounting hardware.

Parts List

The FT0310 weather station consists of the following parts (as referenced in Figure 1).

QTY	Item	Image
1	Display Console Frame Dimensions (Lx H x W): 215X22X158mm LCD Dimensions (L x W): 170 x 125mm	
1	Integrated Outdoor Transmitter Dimensions (L x H x W) : 330x150x280mm	

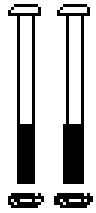
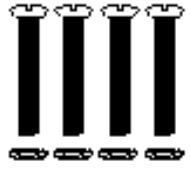
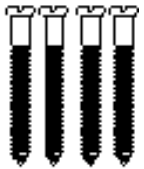
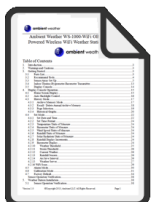
QTY	Item	Image
1	Foot Mounting (with pole insert) Dimensions: 84x 152 x 216mm	
1	Mounting Bracket Back Plate (pole mount) Dimensions: 76 x 102 x 38mm	
1	Mounting Pole Dimensions: 76 x 76 x 25mm	
2	Pole mounting nuts (M3) / bolts Ø3)	
4	Pole mounting nuts (M5) / bolts (Ø5)	
4	Tapping screws	
1	Manual	

QTY	Item	Image
1	Power Adapter	

Figure 1

3.2 Recommend Tools

- Precision screwdriver (for small Phillips screws)
- Compass or GPS (for wind direction calibration)
- Adjustable Wrench

3.3 Sensor Assembly Set Up

The following illustration shows the full segment for Thermo-Hygrometer , WIND,RAIN and UV INDEX sensor .(Display purposes only), as shown in Figure 2.

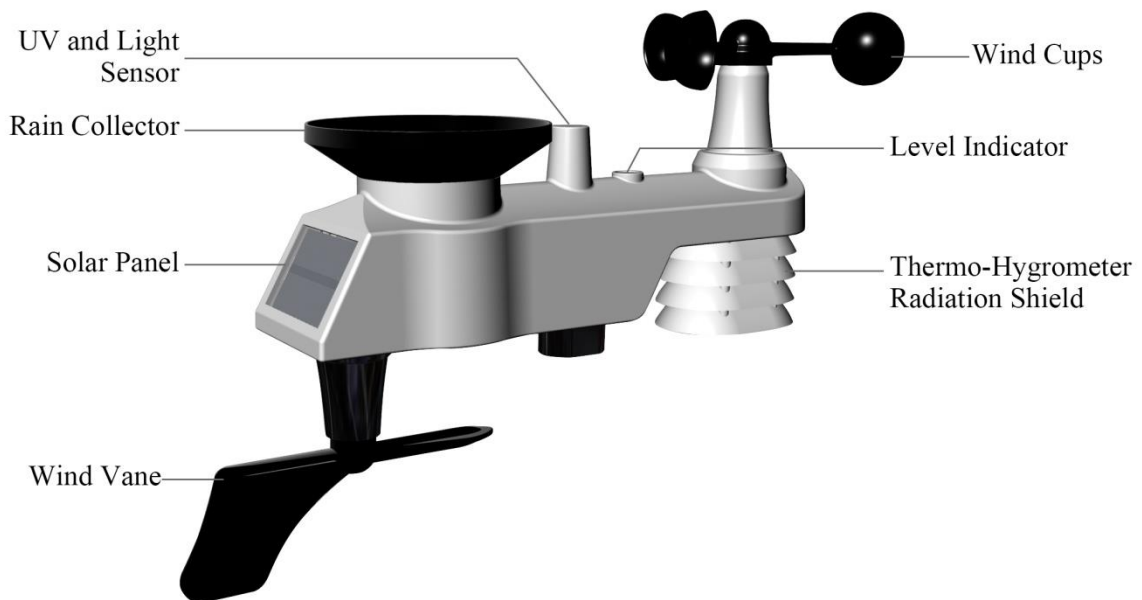

Figure 2

3.3.1 Insert batteries into the transmitter. Locate the battery door on the transmitter, push and open the battery compartment, as show in Figure 3.

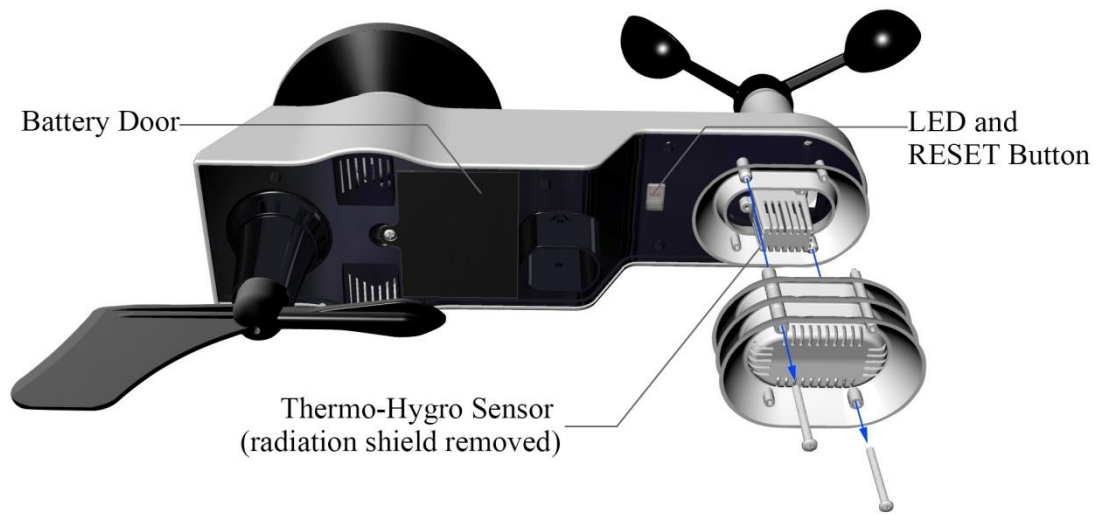

Figure 3

Remove the battery door on the back of the sensor by removing the set screw, as shown in Figure 4.



Figure 4

Inserting 3xAA batteries in the battery compartment, as show in Figure 5.



Figure 5

Close the battery door. Make sure the gasket (around the battery compartment) is properly seated in its trace prior to closing the door. Tighten the set screw.

 **Note:** Do not install the batteries backwards. You can permanently damage the sensors. The solar panel does not charge the batteries, so rechargeable batteries are not needed or recommended.

 **Note:** We recommend installing Lithium AA batteries for sensors. The sensor LED indicator will light for 3 seconds, and then flash once per 16 seconds thereafter. Each time it flashes, the sensor is transmitting data. Replace the battery door and push to tighten it.

 **Note:** If the sensor does not power up after inserting the batteries, press the reset button shown in Figure 6.

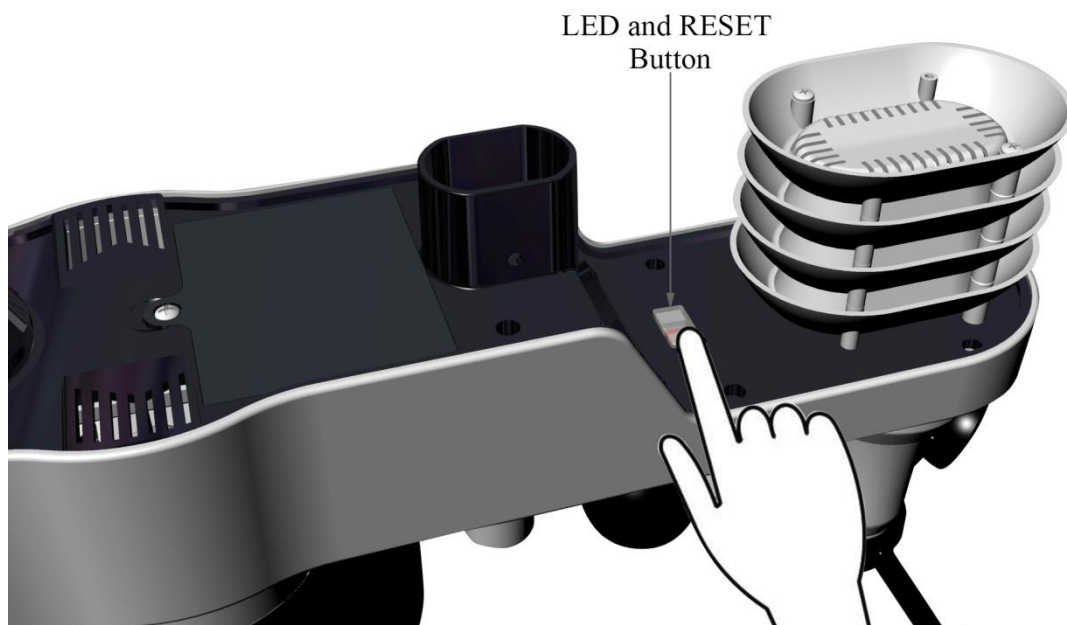

Figure 6

3.4 Display Console

3.4.1 Display Console Layout

The display console layout is shown in Figure 10

 **Note:** The following illustration shows the full segment LCD display for description purposes only and will not appear like this during normal operation.



Figure 10

- | | |
|--|--|
| <ol style="list-style-type: none"> 1. Outdoor temperature display 2. WIFI network 3. Outdoor humidity display 4. Outdoor humidity HI/LO alarm icon 5. Min/Max reset for 24h icon 6. Weather forecast 7. Rainfall display (RATE, 24h, WEEK, MONTH, TOTAL) 8. Rainfall units of measure 9. Date display 10. Time alarm icon 11. Time and Year 12. UV Index display 13. Sunshine intensity 14. MOON phase 15. Sunlight units of measure 16. Indoor Dew point display 17. Indoor Dew point ICON | <ol style="list-style-type: none"> 18. Indoor temperature and humidity display 19. Pressure (REL and ABS) display 20. Pressure units of measure 21. Wind speed average display 22. Wind gust display 23. Wind speed units of measure 24. Wind chill and feels like HI/Lo alarm icon 25. Wind direction 26. OUT dew point and AT (Apparent Temperature) display icon 27. Integrated outdoor transmitter Low power indicator 28. Temperature units (°F or °C) 29. Outdoor temperature HI/LO alarm icon |
|--|--|

3.4.2 Display Console Set Up

It is recommended to plug in the power supply to reduce the battery consumption and extend the service life.

 **Note:** The sensor array must be powered and updating before powering up the console, or the console will time out searching for the sensor. Power the console last.

Make certain the weather station sensor array is at least 3m away from the console and within 30m of the console. If the weather station is too close or too far away, it may not receive a proper signal.

Remove the battery door on the back of the display, as shown in Figure 11. Insert three AAA (alkaline or lithium) batteries in the back of the display console. The display will beep once and all the LCD segments will light up for a few seconds to verify all segments are operating properly.

 **Note:** The character contrast is best from a slightly elevated viewing angle.

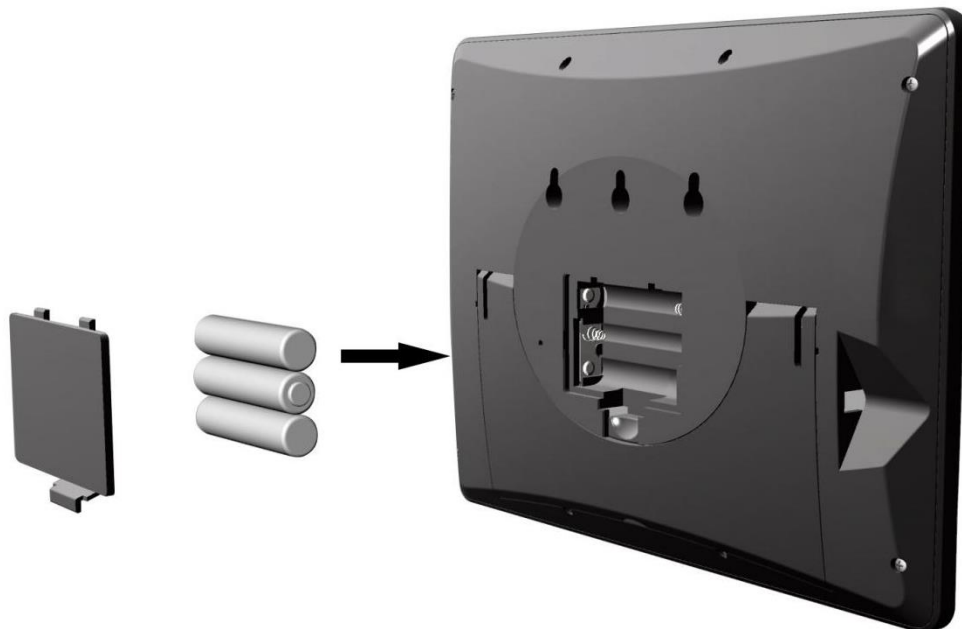



Figure 11

Replace the battery door, and fold out the desk stand and place the console in the upright position.

The unit will instantly display indoor temperature, humidity, pressure, tendency, moon phase, and time. The wind speed, wind gust, wind direction, rain, UV/Sunlight, Integrated outdoor temperature, and humidity will update on the display within a few minutes. Do not Press any menu buttons until the outside transmitter report in, otherwise the outdoor sensor search mode will be terminated. When the outdoor transmitter data has been received, the console will automatically switch to the normal mode from which all further settings can be performed.

While in the search mode, the remote search icon  will be constantly displayed.



If it does not update, please reference the troubleshooting guide in Section 18.

 **Note:** The power adapter is intended to be correctly oriented in a vertical or floor

mounted position. The prongs are not designed to hold the plug-in place if it is plugged into a ceiling, under-the-table or cabinet outlet.



Figure 12

 **Note:** If the power adapter is plugged in, **BL ON** will display in the time area for three seconds when powered up. Conversely, if the power adapter is not plugged in, **AC OFF** will be displayed, the icon  will display.

4. Weather Station Installation

4.1 Pre-Installation Checkout Before installing your weather station in the permanent location, we recommend operating the weather station for one week in a temporary location with easy access. This will allow you to check out all the functions, ensure proper operation, and familiarize you with the weather station and calibration procedures. This will also allow you to test the wireless range of the weather station.

4.2 Site Survey

Perform a site survey before installing the weather station. Consider the following:

1. You must clean the rain gauge once per year and change the batteries every two years. Provide easy access to the weather station.
2. Avoid radiant heat transfer from buildings and structures. In general, install the sensor array at least 5' from any building, structure, ground, or roof top.
3. Avoid wind and rain obstructions. The rule of thumb is to install the sensor array at least four times the distance of the height of the tallest obstruction. For example, if the building is 6m tall, install $4 \times 6\text{m} = 24\text{m}$ away. Use common sense. If the weather station is installed next to a tall building, the wind and rain will not be accurate.
4. Wireless Range. The radio communication between receiver and transmitter in an open field can reach up to 100 m, providing there are no interfering obstacles such as buildings, trees, vehicles, high voltage lines. Wireless signals will not penetrate metal buildings. Most applications will only reach 30m due to building obstructions, walls, and interference.
5. Radio interference such as PCs, radios or TV sets can, in the worst case, entirely cut off radio communication. Please take this into consideration when choosing console or mounting locations.

4.3 Best Practices for Wireless Communication

Wireless communication is susceptible to interference, distance, walls, and metal barriers. We recommend the following best practices for trouble free wireless communication.

1. **Electro-Magnetic Interference (EMI).** Keep the console several feet away from computer monitors and TVs.
2. **Radio Frequency Interference (RFI).** If you have other 433 MHz devices and communication is intermittent, try turning off these other devices for troubleshooting purposes. You may need to relocate the transmitters or receivers to avoid intermittent communication.
3. **Line of Sight Rating.** This device is rated at 100 m line of sight (no interference, barriers, or walls) but typically you will get 30 m maximum under most real-world installations, which include passing through barriers or walls.
4. **Metal Barriers.** Radio frequency will not pass-through metal barriers such as aluminum siding. If you have metal siding, align the remote and console through a window to get a clear line of sight.

The following is a table of reception loss vs. the transmission medium. Each “wall” or obstruction decreases the transmission range by the factor shown below.

Medium	RF Signal Strength Reduction
Glass (untreated)	5-15%
Plastics	10-15%
Wood	10-40%
Brick	10-40%
Concrete	40-80%
Metal	90-100%

5. Final Installation of Sensors

Integrated outdoor transmitter installation.

Professional Wireless Weather Station can be used in both the Northern and Southern Hemispheres.

Prior to installation, you will need to calibrate the wind direction.

5.1. Northern Hemispheres (NOR).

The cardinal directions (N, S, E, W) molded on the body of the outdoor sensor are indicators for the Northern Hemisphere only.

Step 1: There is a “S” indicator on the wind vane that indicates South, as shown in Figure 13. Align this “S” marker in the direction of South.

Step 2: Console operation is set to Northern Hemispheres (**NOR** in the time area) in Location division.

 **Note:** There are four alphabet letter of “N”, ”E”, ”S” and “W” around the wind direction, representing for the direction of North, East, South and West. Wind direction sensor has to be adjusted so that the directions on the sensor are matching with your real location. Permanent wind direction error will be introduced when the wind direction sensor is not positioned correctly during installation.

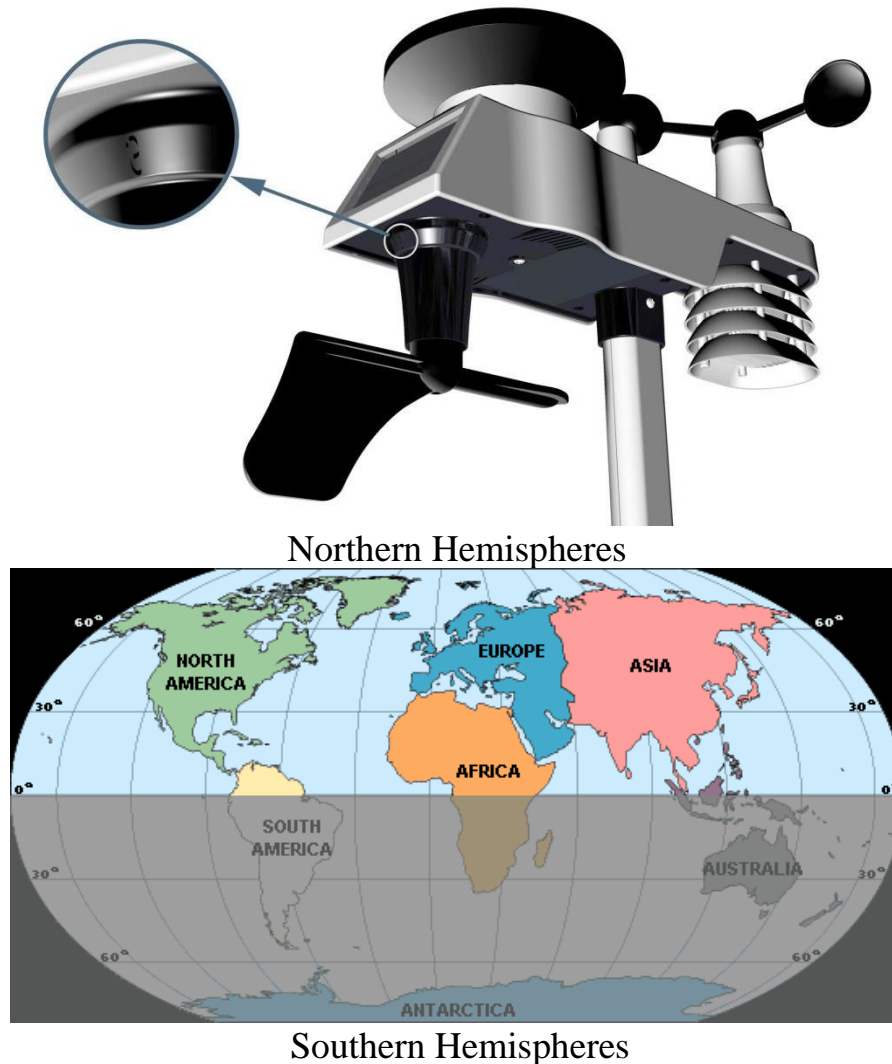



Figure 13

5.2. Southern Hemispheres (SOU).

For Southern Hemisphere installations, ignore these (N, S, E, W) and face **the solar panel to the North** (and in a sunny position) when it comes to installing the Integrated outdoor transmitter.

Step 1: Install the Integrated outdoor transmitter and face the solar panel North.

Step 2: Console operation is set to Southern Hemispheres (**SOU** in the time area) in Location division.

 **Note:** Wind direction sensor has to be adjusted so that the directions on the sensor are matching with your real location. Permanent wind direction error (read approximately 180°) will be introduced when the wind direction sensor is not positioned correctly during installation.

Fasten the integrated transmitter to mounting pole brackets with foot-mounting, two $\phi 3$ bolts and M3 nuts , as shown in Figure 14



Figure 14

Tighten the mounting pole to your existing mounting pole with the four $\phi 5$ Bolts and M5 Nuts assembly, or fix on the wall with four tapping screw, as shown in Figure15.

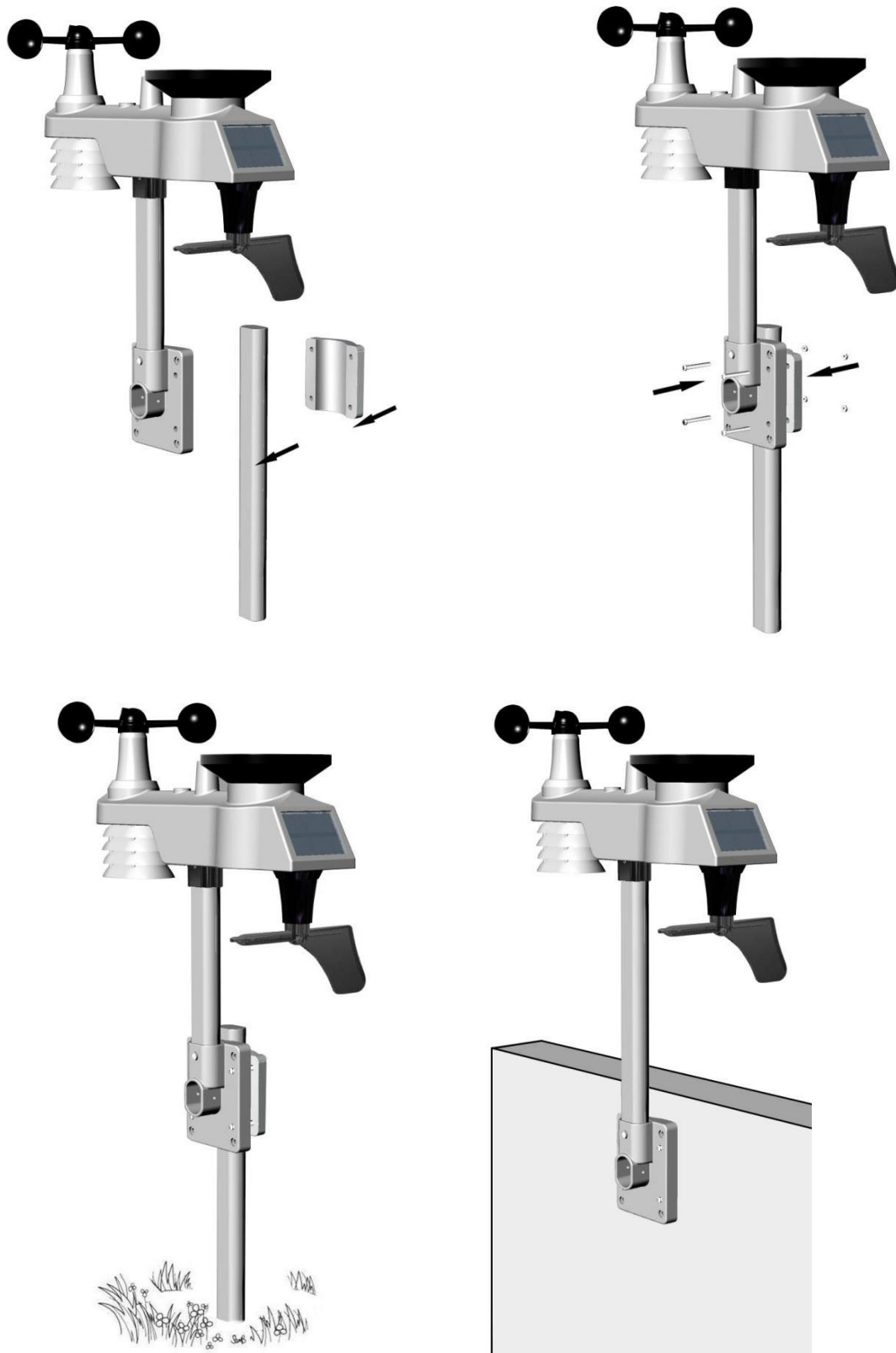



Figure 15

6.Low Battery Icon.

A low battery indicator icon is shown in the display window for Integrated outdoor transmitter. When the low battery icon appears (the battery voltage is lower than 3.6V), replace

the batteries in the sensor with fresh batteries. Be sure to never mix old and new batteries, and never mix battery types such as alkaline and lithium together.

7. Console Operation

 **Note:** The console has five keys for easy operation: **MIN/MAX/-** key, **ALARM** key, **SET/MODE** key, **CHANNEL/+** and **SNOOZE** key.

7.1 Quick Display Mode

 **Note:** To exit the Quick Display Mode at any time, press the **SNOOZE** key of the display console.

While in Normal Mode, press (do not hold) the **SET/MODE** key to enter the Quick Display Mode as follows:

- once for time, time/week and second,
- Twice for rainfall
- three for outdoor dew point temperature.
- four for wind average
- Five for pressure

1. Time, Time/Week and Second. Press the **CHANNEL/+** or **MIN/MAX/-** key to toggle between time, time/week and second.

2. Rainfall. Press the **CHANNEL/+** or **MIN/MAX/-** key to toggle between rate, 24h, week, month and total.

To clear the total rain, press the **CHANNEL/+** or **MIN/MAX/-** button until total rain is displayed. The total rain will flash. Press and hold the **SET** button for five seconds until total rain reads 0.0.

3. Outdoor Dew Point. Press the **CHANNEL/+** or **MIN/MAX/-** key to toggle between AT (Apparent Temperature) and dew point.

4. Wind Average. Press the **CHANNEL/+** or **MIN/MAX/-** key to toggle between current, 2mins and 10 minutes.

5. Absolute Pressure and Relative Pressure. Press the **CHANNEL/+** or **MIN/MAX/-** key to toggle between absolute pressure and relative pressure.

7.2 Set (Program) Mode

While in Normal Mode, press **and hold** the **SET(MODE)** key for at least three seconds to enter the Set Mode. The first setting will begin flashing. You can press the **SET(MODE)** key again to skip any step, as defined below.

 **Note:** In the Set mode, press the **[+]** key or **[-]** key to change or scroll the value. Hold the **[+]** key or **[-]** key for three seconds to increase/decrease rapidly.

 **Note:** To exit the Set mode at any time, press the **SNOOZE** button of the display console.

1. Time SYNC(default: ON). Press the **SET** key again to set the network time sync.

Press the **[+]** key or **[-]** key to switch between SYNC time ON and SYNC time OFF of measure.

2. 12/24 Hour Format (default: 24h): Press the **SET(MODE)** key again to adjust the 12/24 hour format setting (FMT). Press the **[+]** key or **[-]** key to change between 12 hour and 24 hour format.

3. Change Hour. press the **SET(MODE)** key again to set the hour. Press the **[+]** key or **[-]** key to adjust the hour up or down. Note the PM icon is present during afternoon hours.

4. **Change Minute.** Press the **SET(MODE)** key again to set the minute. Press the [+] key or [-] key to adjust the minute up or down.
5. **Date Format (default: MM-DD):** Press the **SET(MODE)** key again to enter the day/month format mode. Press the [+] key to switch between MM-DD, DD-MM.
6. **Change Month.** Press the **SET(MODE)** key again to set the calendar month. Press the [+] key or [-] key to adjust the calendar month.
7. **Change Day.** Press the **SET(MODE)** key again to set the calendar day. Press the [+] key or [-] key to adjust the calendar day.
8. **Change Year.** Press the **SET(MODE)** key again to set the calendar year. Press the [+] key or [-] key to adjust the calendar year.
9. **Max/Min Clearing (default: ON).** Press the **SET(MODE)** key again to set the max/min clearing mode (CLR). The Max/Min can be programmed to clear daily (at midnight) or manually. Press the [+] key or [-] key to switch between “Clears 24h” and Clears Manually.
10. **Temperature Units of Measure (default: °C):** Press the **SET(MODE)** key again to change the temperature units of measure (the **UNITSET** icon will be displayed). Press the [+] key or [-] key to switch between °F and °C units of measure.
11. **Wind Speed Units of Measure (default: m/s).** Press the **SET(MODE)** key again to change the wind speed units of measure. Press the [+] key or [-] key to toggle the wind speed units between m/s, km/h, mph, knots, ft/s or bft.
12. **Rainfall Units of Measure (default: mm).** Press the **SET(MODE)** key again to change the Rainfall units of measure. Press [+] key or [-] key to toggle the rainfall units between mm and inch.
13. **Barometric Pressure Display Units (default: hPa).** Press the **SET(MODE)** key again to change the pressure units of measure. Press the [+] key or [-] key to toggle the pressure units between mmhg, inHg or hPa.
14. **Pressure Threshold Setting (default level 2).** Press the **SET(MODE)** key again to change the pressure threshold. Press the [+] key or [-] key to change pressure threshold 2 mbar/hour to 4 mbar/hour. (For detailed information of this part please refer to 15.5)
15. **Weather Icons Setting (default: partly cloudy).** Press the **SET(MODE)** key again to change the initial weather icon. Press the [+] key or [-] key to select the initial weather icon of Sunny, Cloudy, Partly Cloudy or Rainy. (For detailed information of this part please refer to 15.1 and 15.2)
16. **Sunlight Display Units(default: W/m²).** Press the **SET(MODE)** key again to change the sunlight units of measure. Press the [+] key or [-] key to toggle the sunlight units between , W/m², fc or lux.
17. **Location division.(default: Northern Hemisphere).** Press the **SET(MODE)** key again to change the location division. Press the [+] key or [-] key to toggle the sunlight units Northern Hemisphere (NOR) or Southern Hemisphere(SOU). (**refer to 5.0 Final Installation of Integrated outdoor transmitter**)

7.5 Reset Min/Max record

In normal mode, press (do not hold) the **MIN/MAX/-**-key, the **MAX** icon will be displayed in date area. Press the **SET/MODE** key to view max values of rainfall (rate, 24h, week or month) , pressure (ABS or REL), outdoor temperature and humidity(AT or dewpoint) and indoor temperature and humidity (temp or dew point).

Press the **MIN/MAX/-** key for three seconds to clear all max values. (the rainfall, wind speed, wind gust, pressure, temperature and humidity maximum values. The maximum values will now display the current values) .

Press the **MIN/MAX/-** key again (do not hold), the **MIN** icon will be displayed. Press the **SET/ MODE** key to view min values of pressure (ABS or REL), outdoor temperature/humidity((AT or dew point),and indoor temperature/humidity(temp or dew point).

Press the **MIN/MAX/-** key for three seconds to clear all min values.(the pressure, temperature and humidity minimum values. The minimum values will now display the current values).

Press the **SNOOZE** key to exit the min/max checking and cleaning mode, return to normal display mode.

7.6 Snooze Mode

If the alarm sounds, and you wish to silence the alarm, press the **SNOOZE** key, the backlight will turn on. The alarm icon will continue to flash and the alarm will silence for five minute. press any key (**MIN/MAX/+** ,**SET/MODE**, **ALARM,CHANNEL/+**) to permanently exit the **Snooze** mode.

7.7 Back light Mode

If the LED is off, Press the **SNOOZE** button once. The backlight will turn on for five seconds, and if no operation is performed for three seconds, the backlight will turn off.

The backlight operation is different when operating on batteries to save power.

ADJUSTABLE BACKLIGHT BRIGHTNESS

There are 3 levels of brightness of backlight. When the backlight is on press **SNOOZE** key to switch between the 3 levels.

When backlight is off, press and hold the **SNOOZE** key for two seconds, the backlight will turn on permanently, and **BL ON** icon will be displayed for three seconds in the date area. To turn off the backlight at any time press and hold the **SNOOZE** key for two seconds. **BL OFF** icon will be displayed for three seconds in the date field.

 **Note:** If plugged into AC power, the time area will display AC ON and the backlight will remain on. It is not recommended leaving the backlight on for a long period of time when operating on batteries only, or the batteries will run down quickly.

8.Alarm Mode

The FT0310 includes the following alarms:

- Time (There are two alarms for time. Alarm 1 and Alarm 2)
- Outdoor Temperature
- Outdoor Humidity
- Outdoor AT(Apparent Temperature)
- Outdoor Dew Point
- Outdoor Feels Like Temperature
- Outdoor Dew Point

- Wind Gust
- Wind Average
- Rate Rainfall
- 24 Hour Rainfall
- Absolute Pressure
- Relative Pressure
- Indoor Temperature
- Indoor Humidity
- Indoor Dew Point
- UV Index
- Sunlight

8.1 Alarm Operation

When an alarm condition is exceeded, the alarm icon will flash  (visual) and the alarm beeper will sound (audible). To silence the beeper, press any key.

8.2 Viewing the High and Low Alarms

To view the current alarm settings, press the **ALARM** key to enter the alarm mode. HI AL 1 will be displayed in the date area. At the same time Alarm 1 time and HI alarm parameters of indoor temperature/humidity, outdoor temperature/humidity, rain rate, AT, feels like, wind gust, wind average, absolute pressure, UV index, Sunlight are displayed. Press **SET/MODE** key to view Alarm 2 time and HI alarm parameters of indoor dew point, 24h rainfall, outdoor dew point, and relative pressure.

Press **ALARM** key again to view the LOW alarms along with the alarm clock time the same way HI alarms.

Press the **SNOOZE** key at any time to return to the normal mode.

8.3 Setting the Alarms

Press **ALARM** key to enter the alarm mode.

Press and hold the **SET/MODE** key for three seconds. The first alarm parameter will begin flashing (alarm hour).

To save the alarm setting and proceed to the next alarm parameter, Press (do not hold) the **SET/MODE** key.

To adjust the alarm parameter, press the [+] or [-] key to increase or decrease the alarm settings, or press and hold the [+] or [-] key for three seconds to increase or decrease the alarm settings rapidly.

Press the **ALARM** key to turn on (the alarm icon will appear) and off the alarm.

Press the **SNOOZE** key once at any time to return to the normal mode. After 30 seconds of inactivity, the alarm mode will time out and return to normal mode.

The following is a list of the individual alarm parameters that are set (in order):

1. Alarm hour(alarm 1)

2. Alarm minute(alarm 1)
3. Alarm hour(alarm 2)
4. Alarm minute(alarm 2)
5. Outdoor temperature high alarm
6. Outdoor temperature low alarm
7. Outdoor humidity high alarm
8. Outdoor humidity low alarm
9. Outdoor AT high alarm
10. Outdoor AT low alarm
11. Outdoor dew point high alarm
12. Outdoor dew point low alarm
13. Outdoor feels like high alarm
14. Outdoor feels like low alarm
15. Wind Gust high alarm
16. Wind Average high alarm
17. Rainfall (RATE) high alarm
18. Rainfall (24h) high alarm
19. Absolute pressure high alarm
20. Absolute pressure low alarm
21. Relative pressure high alarm
22. Relative pressure low alarm
23. Indoor temperature high alarm
24. Indoor temperature low alarm
25. Indoor humidity high alarm
26. Indoor humidity low alarm
27. Indoor dew point high alarm
28. Indoor dew point low alarm
29. UV Index high alarm
30. Sunlight high alarm

 **Note:** To prevent repetitive temperature alarming, there is a 0.5 °C tolerance band. For example, if you set the high alarm to 26.7 °C and silence the alarm, the alarm icon will continue to flash until the temperature falls below 26.2°C, at which point, the alarm will reset and must increase above 26.7 °C to activate again.

 **Note:** To prevent repetitive alarming of humidity, there is a 4% tolerance band in humidity alarm. For example, if you set the high alarm to 60% and silence the alarm, the alarm icon will continue to flash until the humidity falls below 56%, at which point, the alarm will reset and must increase above 60% to activate again.

8.4 Alarm and Command Key Beeper ON/OFF Mode

The beeper can be silenced for both alarms and key strokes.

In normal mode, press and hold the **ALARM** key for three seconds to toggle the beeper on or off (depending on the current setting).

The **BZON** (beeper on) or **BZOFF** (beeper off) icon will appear in the time area for three seconds. press and hold the **ALARM** key again for three seconds to toggle the **BZON** or **BZOFF** command.

9. WiFi Connection Status



When the console successfully connects to your Wi-Fi router, the Wi-Fi signal icon will appear on the LCD display (behind the Outdoor humidity). If the Wi-Fi signal is not stable or the console is trying to connect to the router, the icon will flash. If the icon disappears, it means the console is not connected to the Wi-Fi router.

Note: If you own a dual band router (2.4 GHz and 5.0 GHz), make sure you connect to the 2.4 GHz band, otherwise it will fail to connect the weather station to WiFi.

10. Time Server Sync Status

After the console has connected to the internet, it will attempt to connect to the internet time server to obtain the time. Once the connection succeeds and the console's time has updated, the SYNC icon **SYNC** will appear on the LCD. The time will automatically synchronize to the internet per an hour.

Note: Time synchronize method: Synchronized through internet UTC time server.

WiFi Connection and Weather Servers

11. Register with WeatherCloud.net

Note: This is best done on a computer desktop or laptop.

Visit : <https://weathercloud.net/> and enter a Username, Email and Password (**It is your Login password of the website, not your email password. So no privacy will be exposed.**).

11.1 Sign Up

1) Click Sign up as below

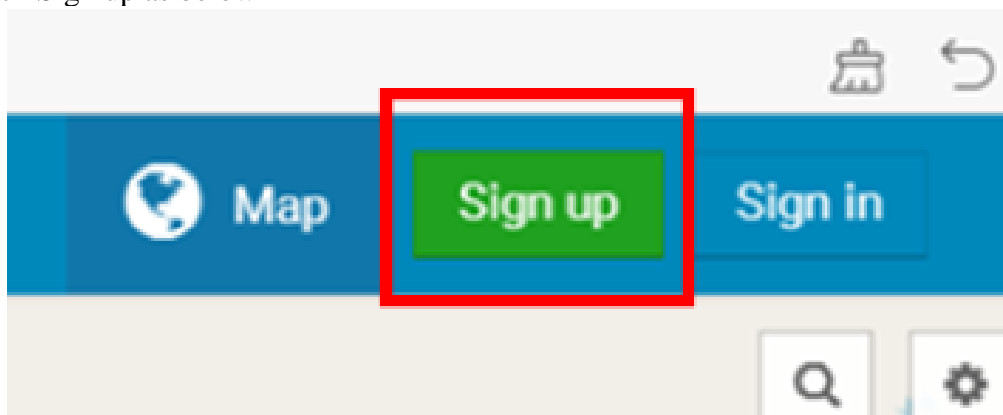

Figure 17

2) As shown below, enter a Username, Email and Password then Click Sign up.

Join Weathercloud

uct5
[redacted]@qq.com

Sign up
By clicking Sign up, you agree to our [Terms of Service and Privacy Policy](#).

Figure 18

3) As shown below, an email will be received in your registered mailbox .

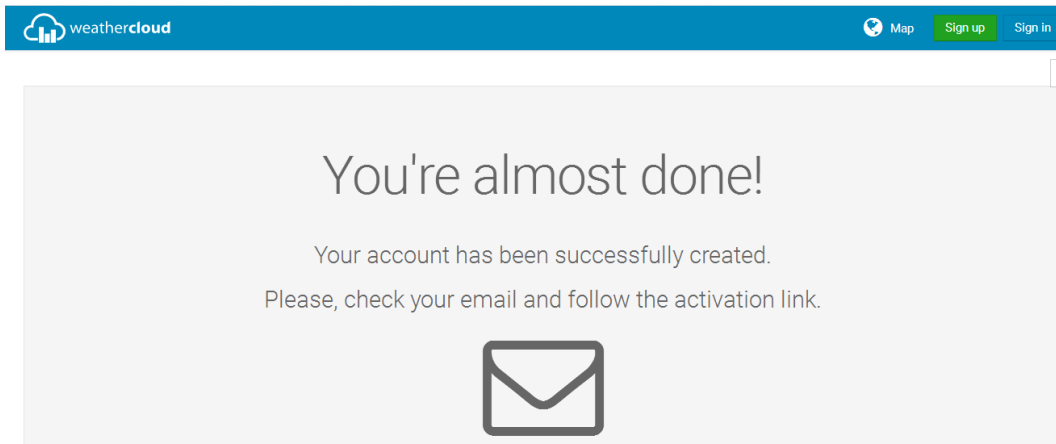

Figure 19

4) As shown below, open your mail and log in to the Web address in the mail.

Hello [redacted]

Thanks for registering and welcome to Weathercloud!

To activate your new account please click on the link below or copy and paste the URL into your browser:

<https://app.weathercloud.net/page/activate/key/Lyfkalj48ZJwAvPMzys7X0F3a5RuXwF7LG4xhhu6Hh6LvHzNgKI2i1aYUjmNm1lv>

Figure 20

5) As shown below, click “here” to enter the homepage of the weathercloud website.

Welcome to Weathercloud!

Your account has been successfully activated.
Click [here](#) to sign in using your new credentials.

Weathercloud uses cookies and similar technologies to customize the content we provide and to analyze the navigation in order to offer you a better, faster and safer experience. To use Weathercloud, you must agree to the use we make of these technologies. [Read more.](#)

I agree

Figure 21

6) As shown below, enter the email address and password you just registered to enter the weathercloud website.

Sign in

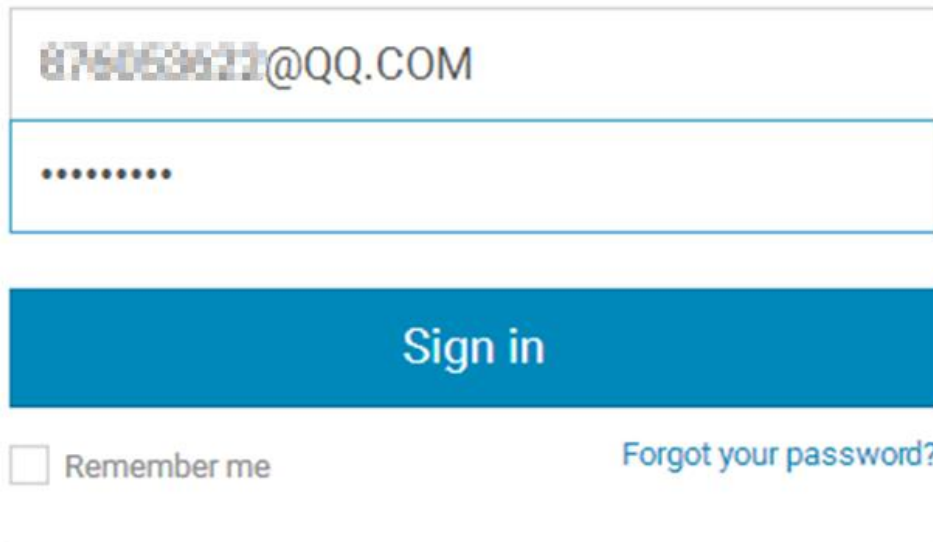

The sign-in form consists of two input fields stacked vertically. The top field contains the email address "876053623@QQ.COM". The bottom field contains a series of ten dots representing a password. Below the fields is a large blue button with the text "Sign in". To the left of the button is a checkbox labeled "Remember me". To the right of the button is a link labeled "Forgot your password?".

Not a member yet? [Sign up for free.](#)

Figure 22

11.2 Add a weather station device (it may take a few minutes).

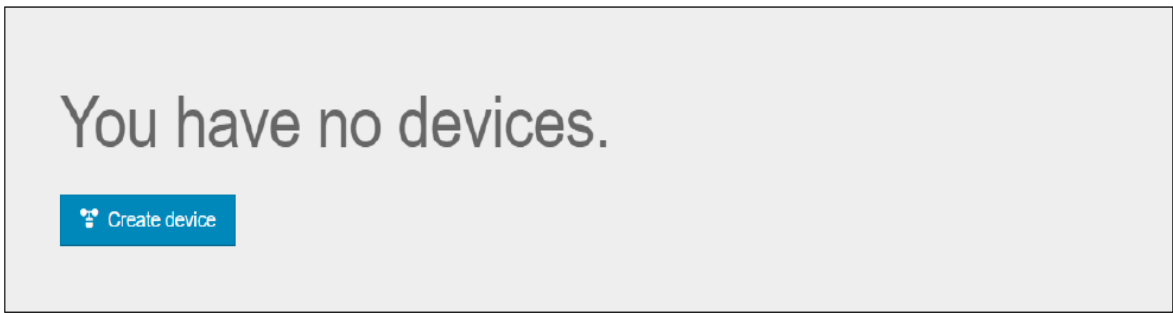

Figure 23

1) After sign up you will be prompted to add a device/ Select “Create device” and enter your station’s information:
Blanks with red * must be filled in.

A registration form with two columns of fields. The left column contains: "Name *" with value "FT0300", "Model *" with value "Ultimeter 100 Series", "Link type *" with value "Weather Display", "Website" with value "www.example.com", and "Description" with an empty text area. The right column contains: "Country *" with value "Hong Kong", "State / Province *" with value "Hong Kong", "City *" with value "Hong Kong", "Time zone *" with value "(UTC+08:00) Hong Kong", "Get coordinates" button, "Latitude *" with value "23.241346102386135", "Longitude *" with value "118.125", and "Elevation" with value "0.0" and a unit "m".

Figure 24

Note: You can select any Model number and Link type in the above blanks.
2) As shown below, click Get coordinates to identify your location of on the map, then click Done to confirm..

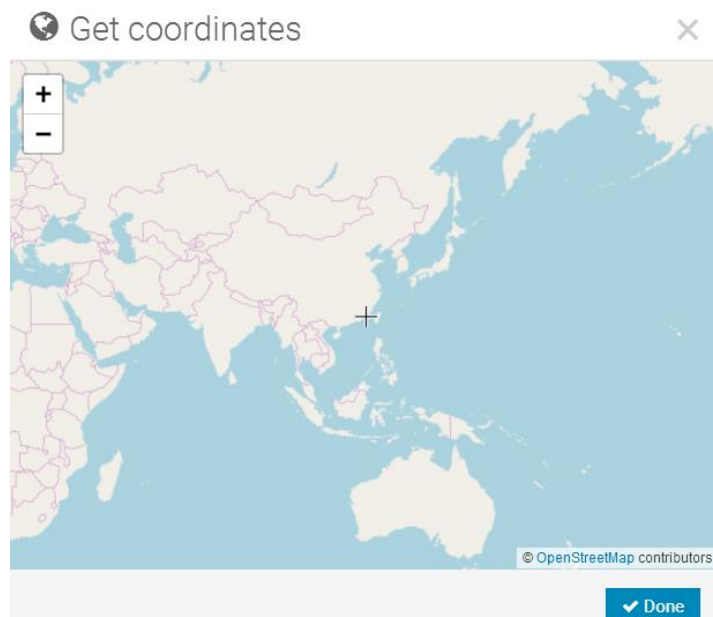

Figure 25

3) As shown below, click Create.

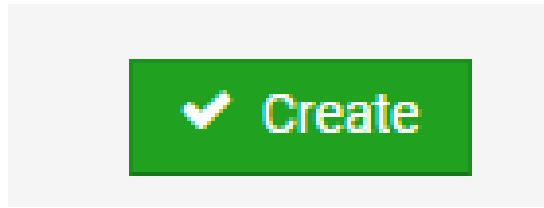

Figure 26

4) As shown below, after registering successfully, please record the Weathercloud ID and Key information for later use. (Refer to 13.6)

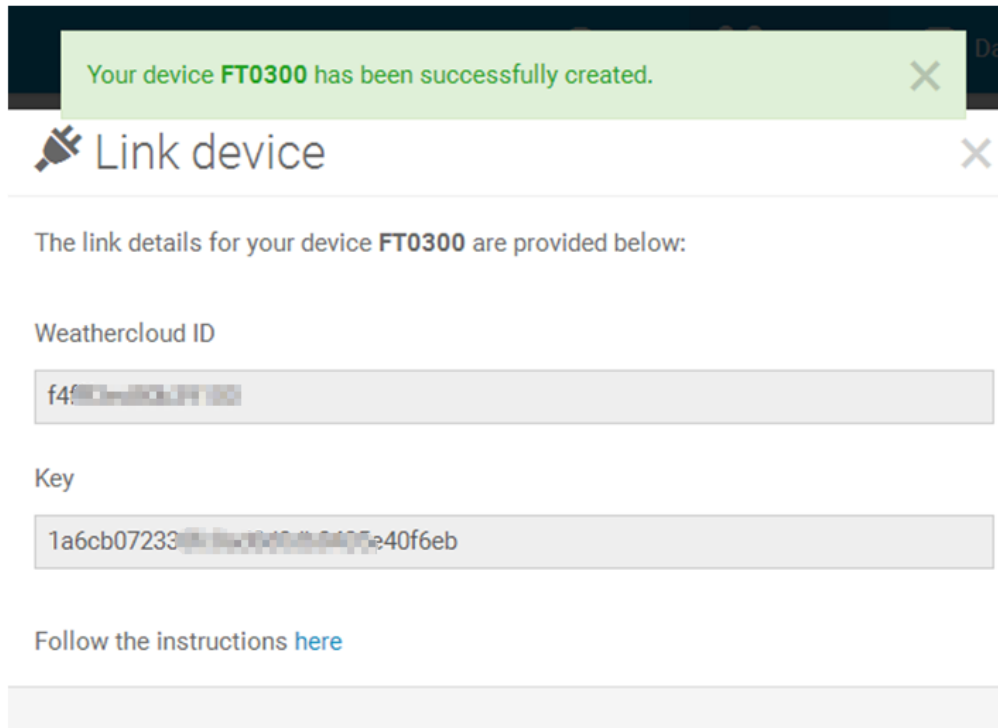

Figure 27

12. Register at Wunderground.com (Weather Underground)

 **Note:** The Weather Underground website is subject to change.

Visit: <https://Wunderground.com> , and select the Join link in the upper right and corner and create a Free Account.

1) as shown below , Click Join

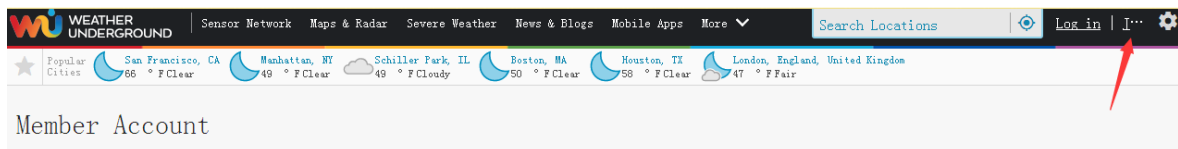

Join Weather Underground

- Choose real-time alerts for your city.
- Choose adding your webcam or personal weather station.
- You can delete your account at any time from your member settings.

The Weather Company needs your email to create your Weather Underground account.

Email

Password (5-30 characters) [Show](#)

Confirm New Password:

I agree to the [Terms of Use](#)

Figure 28

2) As shown below, enter a Username, Email and Password (**It is your Login password of the website, not your email password. So no privacy will be exposed.**). Click Sign up for free.

Join Weather Underground

- Choose real-time alerts for your city.
- Choose adding your webcam or personal weather station.
- You can delete your account at any time from your member settings.

The Weather Company needs your email to create your Weather Underground account.

Email

 ✓

Password (5-30 characters) [Show](#)

 ✓

Confirm New Password:

I agree to the [Terms of Use](#)

[Sign up for free](#)

[Already have an account? Sign in](#)

Figure 29

3) As shown below, registration is done successfully.

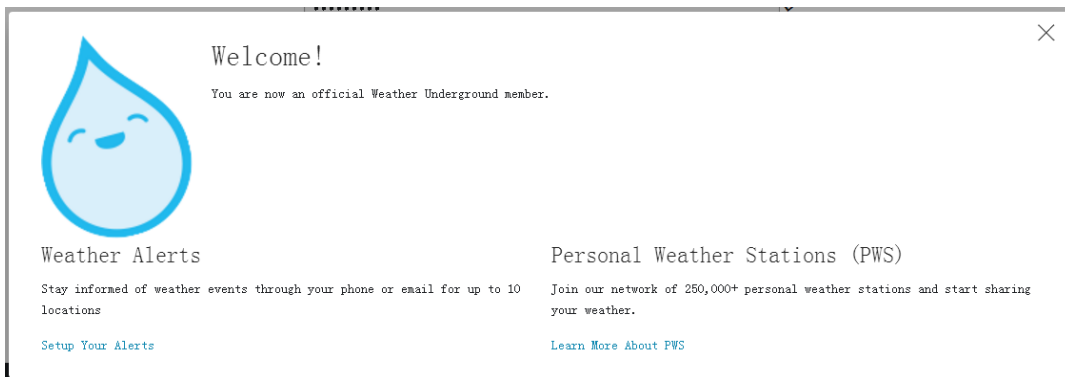
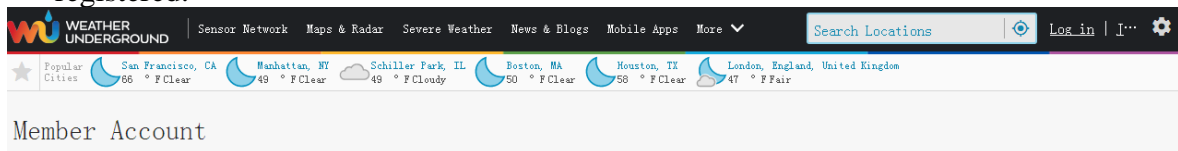

Figure 30

4) As shown below, click Log in and enter the email address and password you just registered.



Sign in to Weather Underground!

Email

Password [Forgot your password?](#)

[Sign in](#)

[Don't have an account? Sign up](#)

[Terms of Use](#) | [Privacy Policy](#)

Please read these terms carefully. By using Weather Underground or signing up for an account, you're agreeing to these terms.

Figure 31

5) As shown in the below, click My Profile. Then enter Member Settings.

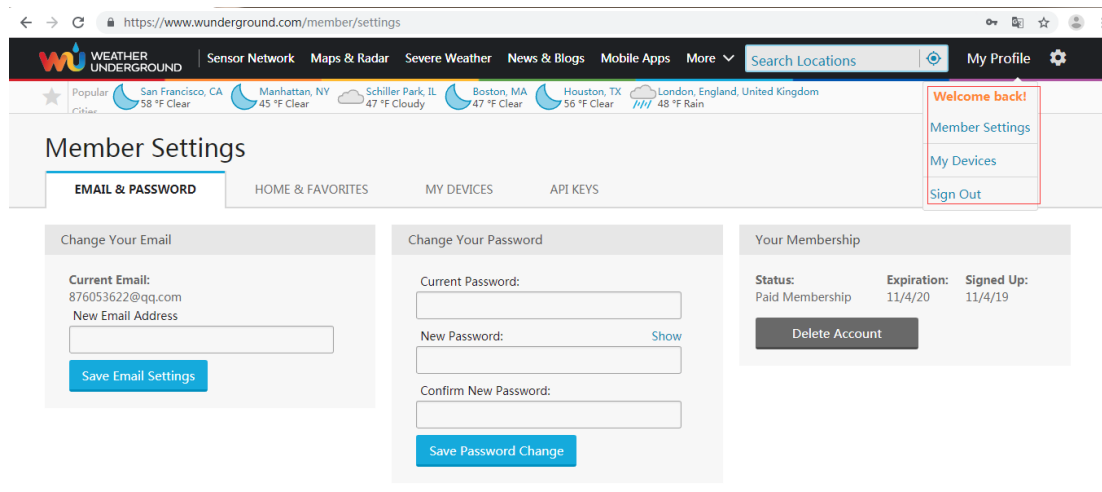

Figure 32

6) As shown below, click Update home location.

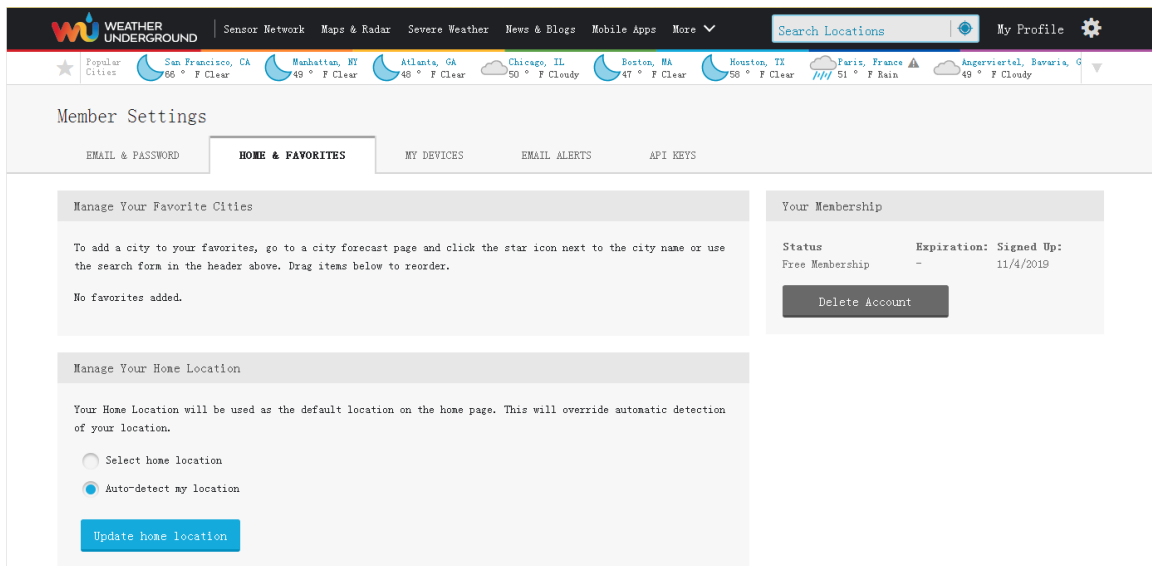

Figure 33

7) As shown below, you will then be prompted to add a device/ Select “Add New Device

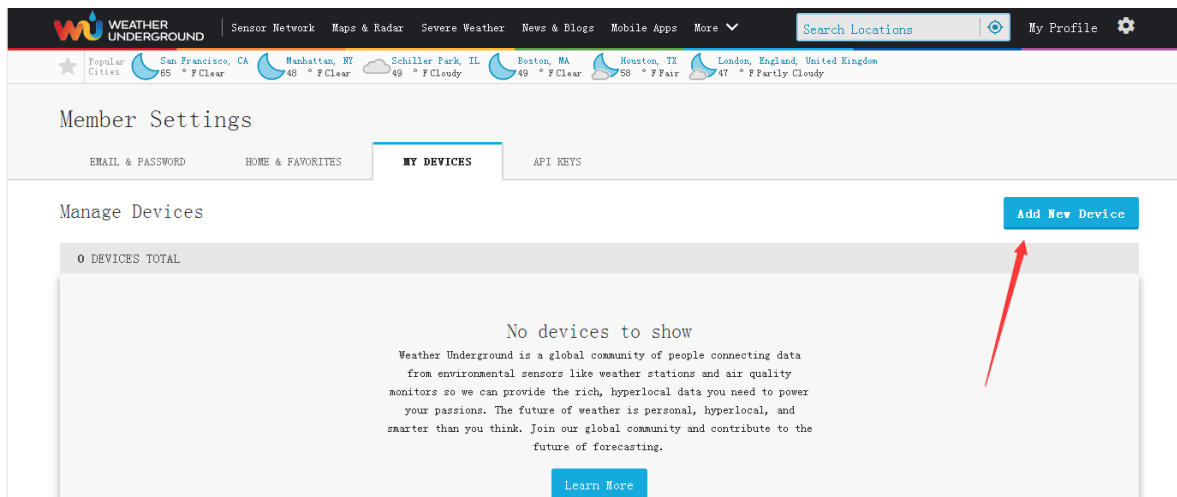

Figure 34

8) As shown below, click Personal Weather Station.

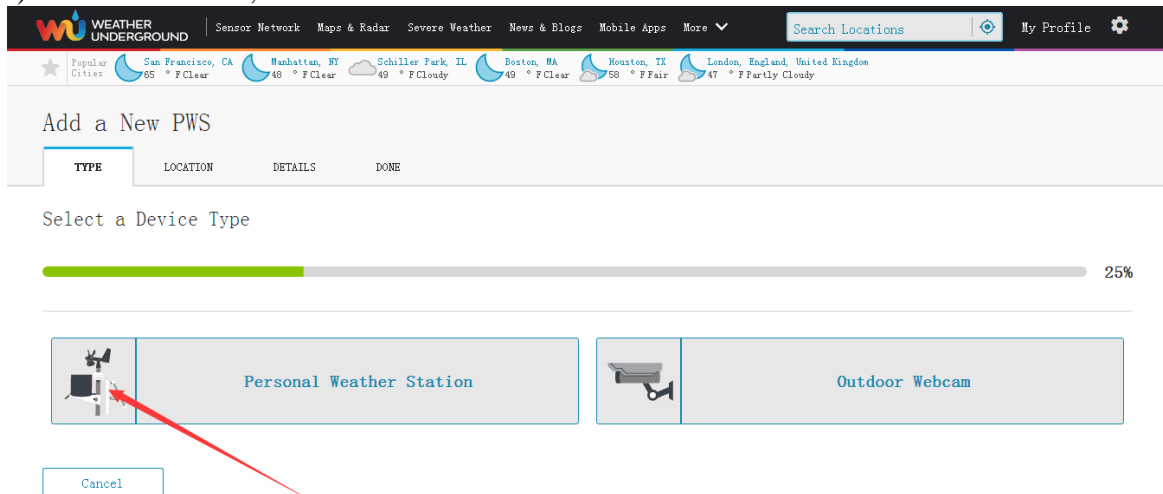
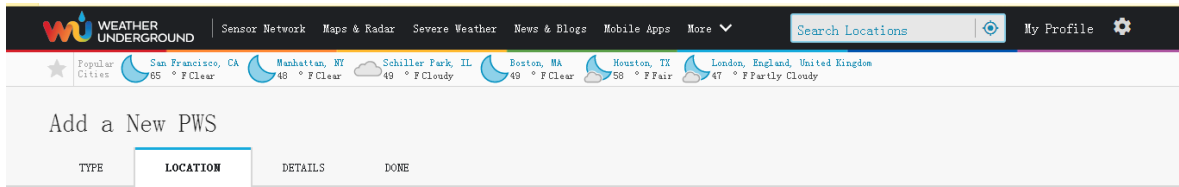

Figure 35

9) As shown below, select Address by inputting an address or select Manual to position your address automatically. Then click Next:



Set Device Name & Location



Device Location:

Address Manual

Enter Address

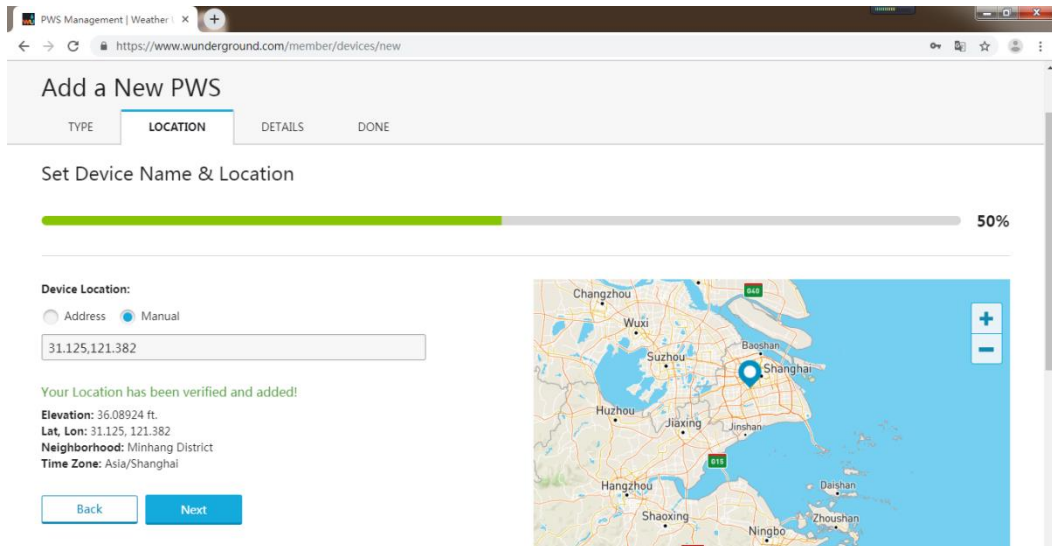
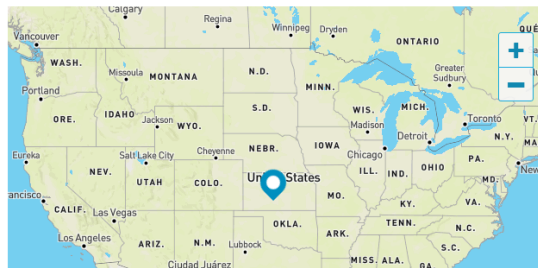

Figure 36

10) As shown below, you will then be prompted to add a device/ Select “Create device”, then click I Accept and Next:

Blanks with red (Required) must be filled in.

Note: You can select any wifi weather station model in Device Hardware blank.

Name: (Required)

Surface Type:

Elevation: (Required)

Associate Webcam:

Device Hardware: (Required)

 Select device hardware
 Airmar 150wx Ultrasonic
 Airmar 200wx Ultrasonic
 AcuRite 3-in-1 Weather Station with Wi-Fi
 AcuRite 5-in-1 Weather Station with Wi-Fi
 AcuRite 5-in-1 Weather Station with AcuRite Access
 AcuRite Atlas Weather Station with AcuRite Access
 AcuRite Basic Weather Station with Wi-Fi
 AcuRite Basic Weather Station with AcuRite Access
 AcuRite Pro Weather Center
 Ambient Weather WS-0262A
 Ambient Weather WS-0265
 Ambient Weather WS-1000 (Wireless)
 Ambient Weather WS-1001-WiFi (Wireless)
 Ambient Weather WS-1002-WiFi (Wireless)
 Ambient Weather WS-1200-IP (Wireless)
 Ambient Weather WS-1400-IP (Wireless)
 Ambient Weather WS-2000
 Ambient Weather WS-2090 (Wireless)
 Ambient Weather WS-2902

Height Above Ground:

You Make Our Forecasts More Accurate, We Respect Your Privacy
 Contribute to the Weather Underground community by sharing some information about yourself and your sensor. We use this information to manage your account and to improve the experience from the Weather Underground community. We may also share certain data for commercial purposes, such as your sensor location.
[Learn more about how we take your privacy seriously](#)
 (Required)
 I Accept I Deny

Email Preferences:
 I would like to receive PWS notifications.

Figure 37

11) As shown below, after registering the host successfully, please record Station ID and Station Key information for later use (refer to 13.6).

Registration Complete!

100%

Congratulations! Your personal weather station is now registered with Weather Underground.

Enter the information below to your weather station software.

Your PWS
 Station ID: ██████████6
 Station Key: ██████████700a





Figure 38

12) As shown below, registration is done successfully.

1 DEVICES TOTAL							
Name	Location	Status	ID	Key	Type	Manage	
FT0300	Shanghai (Otuangpu District), CN	Offline	ISHANG26	ondw70oa	PWS	Edit	Delete

Figure 39

13. WiFi Setup (Connect your Device to the Console's WiFi)

When you first power up (AC) the console, or press and hold the MIN/MAX/- button for three seconds in normal mode, the console icon (behind the Outdoor humidity)  will flash to signify that it has entered WAP (wireless access point) mode, and is ready to enter for WiFi settings.

You can use your desktop, laptop, tablet, or smart phone to connect to the console's WiFi. The console's network name begins with WeatherHome, followed by a unique code.

Note that when the console programming is complete, you will resume your default WiFi connection.

Note that you cannot connect two or more devices at the same time when WAP mode.

13.1: Example 1: Connect to the console WiFi server with a PC.

Choose WiFi network settings from Windows (or search "Change Wi-Fi Settings" from Windows), and Connect to the WeatherHome----- WiFi network, as shown in Figure 40 (your WiFi network name may be slightly different, but will always begin with WeatherHome -).

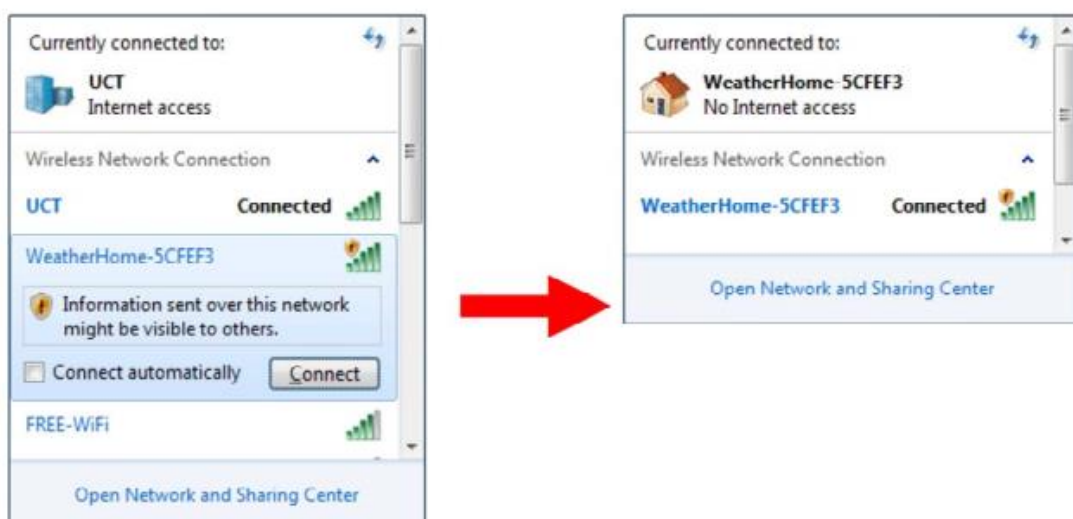



Figure 40

13.2: Example 2. Connect to the console WiFi server with a Mac.

Choose the Settings icon  and  Network . Connect to the WeatherHome----- WiFi network, as shown in Figure 41 (your WiFi network name may be slightly different, but will always begin with WeatherHome-----).

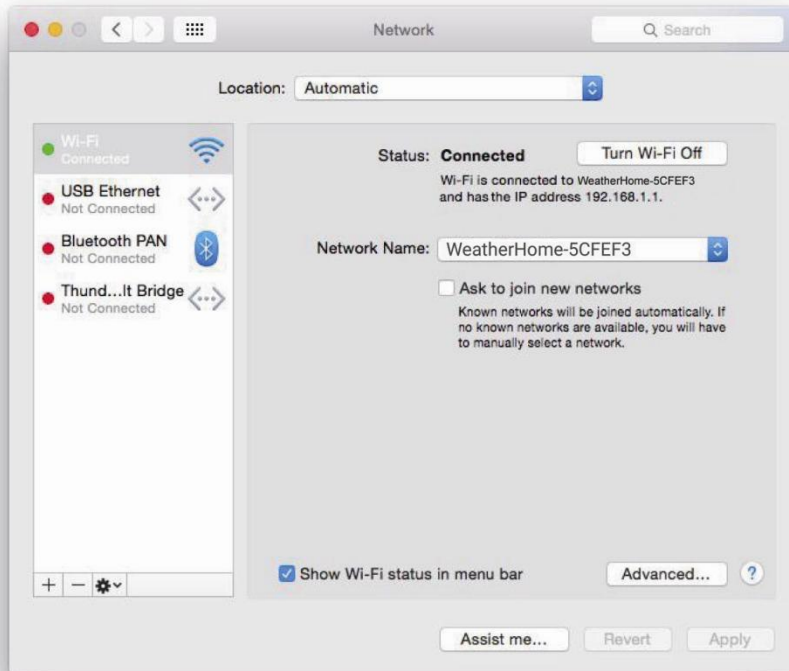

Figure 41

13.3: Example 3. Connect to the console WiFi server with an iPhone or iPad.



Choose the Settings icon  and Wi-Fi. Connect to the WeatherHome----- WiFi network, as shown in Figure 42 (your WiFi network name may be slightly different, but will always begin with WeatherHome-----).



Figure 42

13.4: Example 4. Connect to the console WiFi server with an Android.

From the Apps icon, choose the Settings icon  and Wi-Fi. Connect to the Weather-Home----- WiFi network, as shown in Figure 43 (your WiFi network name may be slightly different, but will always begin with WeatherHome-----).

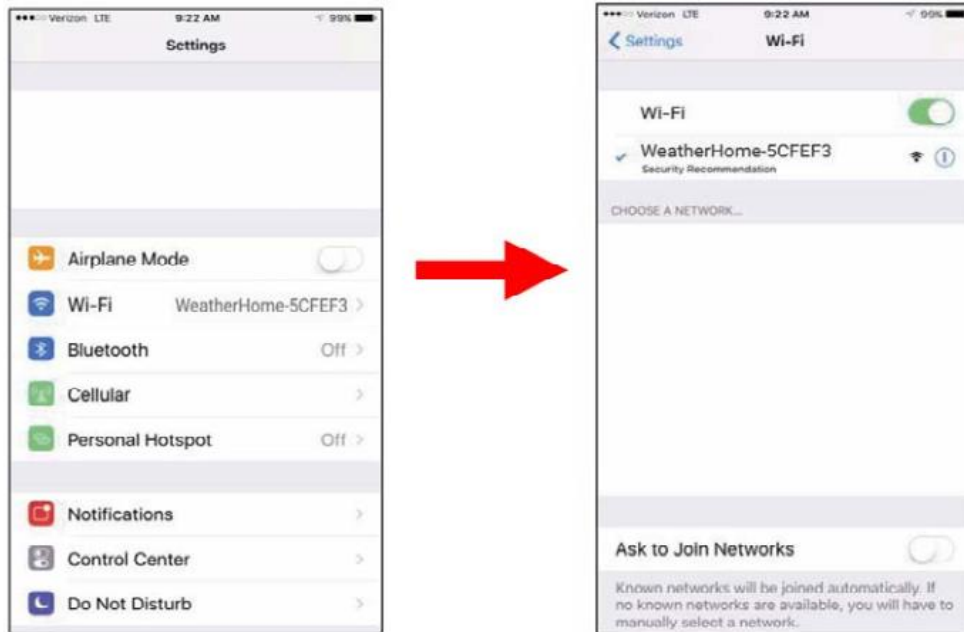



Figure 43

13.5. Once connected, enter the following IP address into any browser's address bar:**http://192.168.5.1**to access the console's web interface.

 **Note:** Some browsers will treat 192.168.5.1 as a search, so make sure you include the header **http://**,or:
http://192.168.5.1 not 192.168.5.1

13.6. Enter the following information into the web interface (Figure 44). Make sure all of the information is entered prior to selecting Save. If you choose not to upload Wunderground.com, or upload weathercloud.net, leave the check boxes unchecked.

The screenshot shows the RAGOVA Weather Setting web interface. At the top, the browser address bar contains `http://192.168.5.1/`. The page title is "RAGOVA Weather Setting".

Wi-Fi network setup

- Network:** A dropdown menu with a list icon. Annotation: "Select your WiFi Router (SSID) from the list".
- Password:** A text input field with an eye icon. Annotation: "Router's password".
- Check:** A checkbox. Annotation: "Check to connected IP status if saved setting".

Weather server setup

- Upload wunderground.com:** A checked checkbox. Annotation: "Check to confirm upload to Weather underground server".
- ID:** A text input field. Annotation: "Enter Your Station ID".
- Password:** A text input field. Annotation: "Enter Your Station Key / Password".
- Upload ambientweather.net:** A checked checkbox. Annotation: "Check to confirm upload to AmbientWeather.net".
- MAC:** A text input field. Annotation: "Mac address (Automatic reading)".
- Upload weathercloud.net:** An unchecked checkbox. Annotation: "Check to confirm upload to weathercloud.net".
- ID:** A text input field. Annotation: "Enter Your Weathercloud ID".
- Key:** A text input field. Annotation: "Enter Your Weathercloud Key / Password".

Time Zone Setup

- Time Zone:** A dropdown menu. Annotation: "Time Zone Settings".
- Automatically adjust clock for Daylight Saving Time:** An unchecked checkbox. Annotation: "DST on/off".

Internet Time Server Setup

- Server:** A text input field containing "time.nist.gov". Annotation: "Internet time server".

Save: A blue button. Annotation: "Press Save to confirm the setting".

Figure 44

Notes: Hidden SSIDs. If you have a hidden SSID, enter the SSID manually.

Time Zone Settings(default: 0h). based on the number of hours from Coordinated Universal Time, or Greenwich Mean Time (GMT).

The following table provides times zones throughout the world. Locations in the eastern hemisphere are positive, and locations in the western hemisphere are negative.

Hours from GMT	Time Zone	Cities
-12	IDLW: International Date Line West	---
-11	NT: Nome	Nome, AK
-10	AHST: Alaska-Hawaii Standard CAT: Central Alaska HST: Hawaii Standard	Honolulu, HI
-9	YST: Yukon Standard	Yukon Territory
-8	PST: Pacific Standard	Los Angeles, CA, USA
-7	MST: Mountain Standard	Denver, CO, USA
-6	CST: Central Standard	Chicago, IL, USA
-5	EST: Eastern Standard	New York, NY, USA
-4	AST: Atlantic Standard	Caracas
-3	---	São Paulo, Brazil
-2	AT: Azores	Azores, Cape Verde Islands
-1	WAT: West Africa	---
0	GMT: Greenwich Mean WET: Western European	London, England
1	CET: Central European	Paris, France
2	EET: Eastern European	Athens, Greece
3	BT: Baghdad	Moscow, Russia
4	---	Abu Dhabi, UAE
5	---	Tashkent
6	---	Astana
7	---	Bangkok
8	CCT: China Coast	Beijing
9	JST: Japan Standard	Tokyo
10	GST: Guam Standard	Sydney
11	---	Magadan

Hours from GMT	Time Zone	Cities
12	IDLE: International Date Line East NZST: New Zealand Standard	Wellington, New Zealand

13.7. If all of the information you entered is correct press save to confirm(Figure 45). If it does not, check your web interface information again.







Figure 45

13.8. Once the setup is completed, disconnect your device from the console WiFi. Otherwise, the console will automatically exit WAP mode. (Figure 46)



Figure 46

If the connection is successful, the Wi-Fi console's status Wi-Fi icon  will stop flashing and remain on.

 **NOTE:** When the console successfully connects to your any website of weather servers, the data signal icon  will appear on the LCD display(behind the Outdoor humidity). If the data signal icon  is flashing, the console is currently uploading to the server. If the icon  disappears, the console is not connected to the weather server for more than 30 minutes.

13.9 Viewing your Data on Weather Underground

Visit:<http://www.wunderground.com/personal-weather-station/dashboard?ID=STATIONID>

where STATIONID is your personal station ID (example, KCALOSAN782).

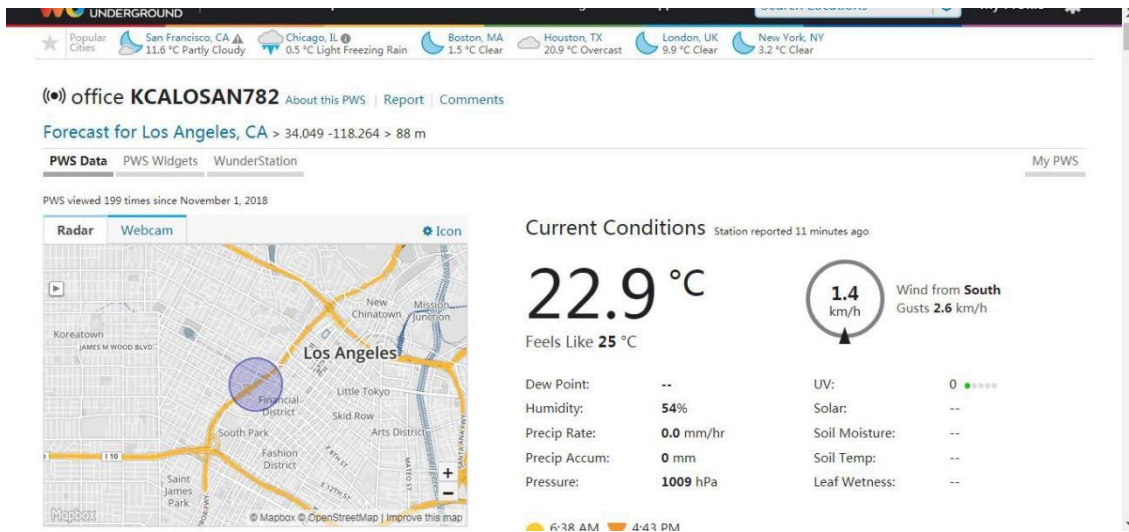

Figure 47

Multiple Sensor Features

Wunderground.com does not support multiple sensor channels.

Note: The current temperature and humidity data is the Integrated Outdoor Transmitter.

13.10. View your data on Weathercloud.

Visit the website www.weathercloud.net and sign in with your e-mail address and password. Then you will go to the weather data of your weather station automatically.

14. Upgrade firmware

You may get the latest firmware of the console as below

14.1. When you first power up(AC) the console, or press and hold the MIN/MAX/-(WiFi) button for three seconds in normal mode, the console icon(behind the Outdoor humidity))

 will flash to signify that it has entered WAP (wireless access point) mode, and is ready to enter for WIFI settings.

14.2. Use your smart phone, tablet, or computer to connect to the console through WiFi(reference: **Example 1-4 of WiFi Setting**).

14.3. Once connected, enter the following IP address into the browser's address bar:
<http://192.168.5.1/upgrade.html>



Figure 48

14.4. Once connection succeeds, it will jump to “Upload Setting” screen automatically.

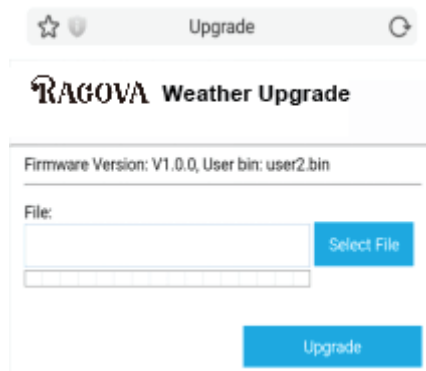

Figure 49

14.5. Press Select File key to select the upgraded firmware as figure 50.

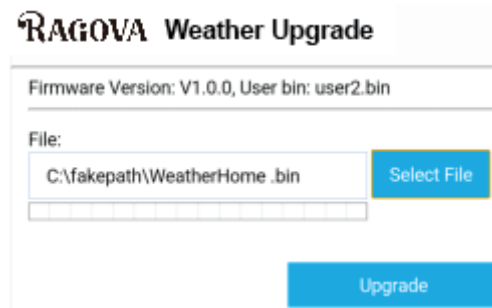

Figure 50

14.6. If update successfully when press Upgrade key. Then you will see.

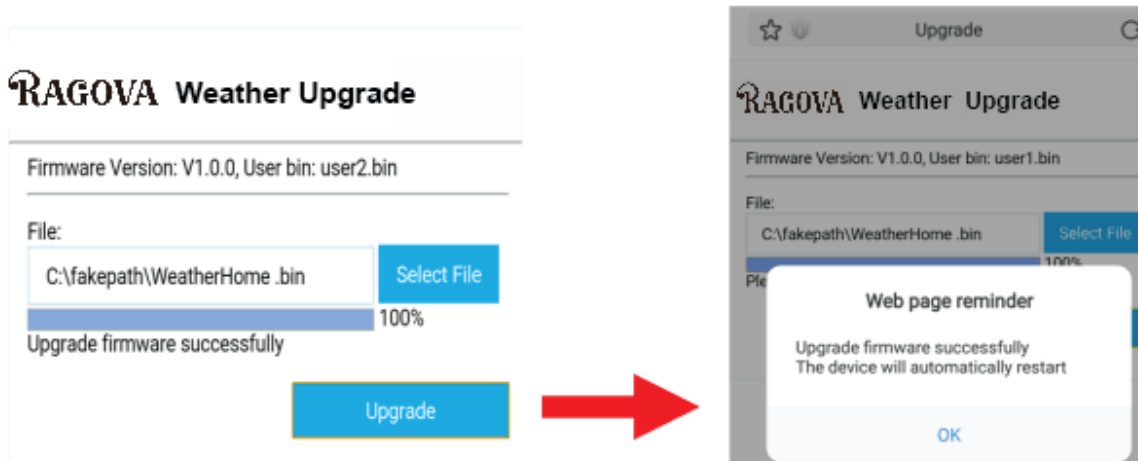

Figure 51

NOTE: In this upgrade only Wifi firmware is updated. The console does not reset.

14.7. Once the upgrade is completed, the console will automatically exit WAP mode.

15. Other Console Features





The following section describes additional features and display icons.

15.1 Weather Forecasting

 **Note:** The weather forecast or pressure tendency is based on the rate of change of barometric pressure. In general, when the pressure increases, the weather improves (sunny to partly cloudy) and when the pressure decreases, the weather degrades (cloudy to rain).

The weather forecast is an estimation or generalization of weather changes in the next 24 to 48 hours, and varies from location to location. The tendency is simply a tool for projecting weather conditions and is never to be relied upon as an accurate method to predict the weather.

15.2 Weather Icons

Condition	Icon	Description
Sunny		Pressure is rising and the previous condition is partly cloudy.
Partly Cloudy		Pressure is falling and the previous condition is sunny or Pressure is rising and the previous condition is cloudy.
Cloudy		Pressure is falling and the previous condition is partly cloudy or Pressure is rising and the previous condition is rainy.
Rainy		Pressure is falling and the previous condition is cloudy.

15.3 Moon Phase

The following moon phases are displayed based on the calendar date.

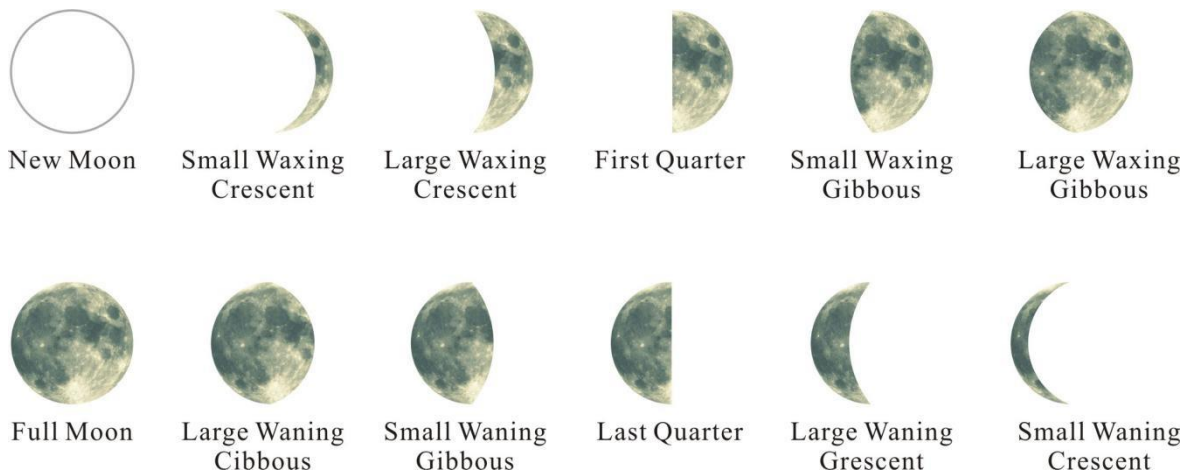

15.4 Feels Like Temperature and AT

Feels like temperature is a combination of Heat Index and Wind Chill.

At temperatures less than 4.4C(40°F), the wind chill is displayed, as shown in the National Weather Service Wind Chill Table below:

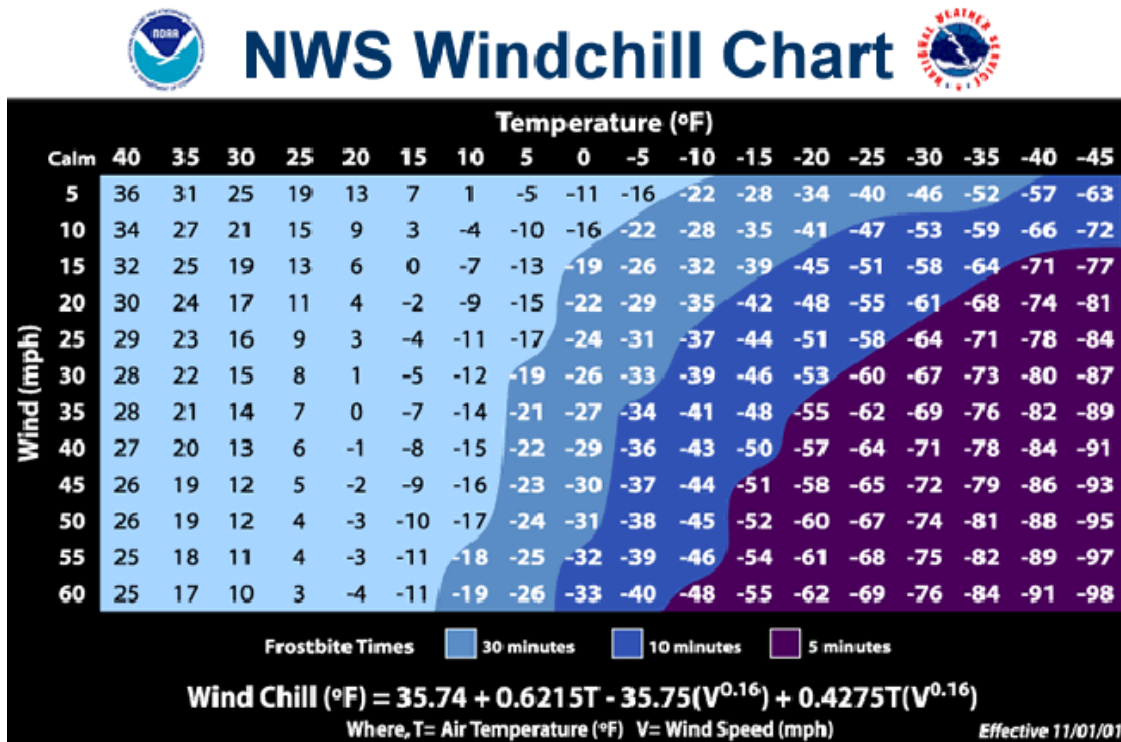

Figure 17

At temperatures greater than 26.7C(80°F), the heat index is displayed, as shown in the National Weather Service Heat Index Table below:

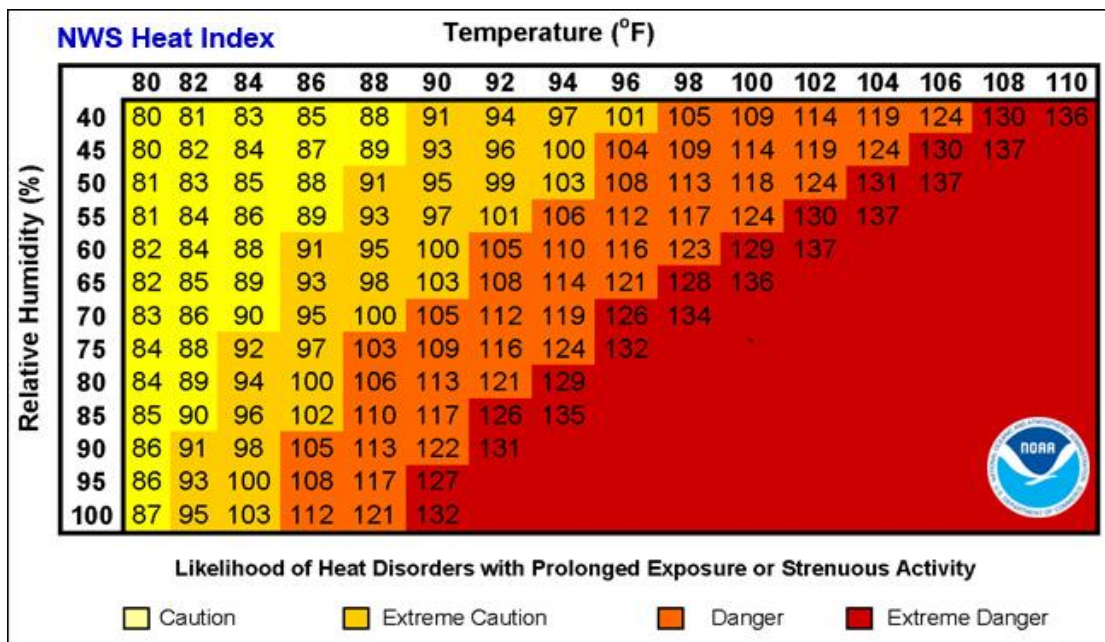

Figure 18

When the temperature is between 4.4C (40°F) and 26.7C (80°F), the OUT temperature is displayed (Feels Like temperature is the same as OUT temperature).

The concept of apparent temperature (AT) is a linear regression that is not restricted, and is more appropriate to outside conditions because it includes wind. and was intended as an assessment of what exposed body surfaces feel like in cold, windy conditions. Regression equations of this universal scale are formulated for indoors, outdoors in shade but exposed to wind, and outdoors exposed to wind and solar radiation. Of these, outdoors in shade but exposed to wind, has been chosen as most informative.

15.5 Pressure Threshold Setting

The pressure threshold (the negative or positive rate of change of pressure signifying a change in the weather) can be adjusted from 2 mbar/hour to 4 mbar/hour (default level 2 mbar/hour).

The lower the level pressure threshold setting, the higher sensitivity for weather forecast changes. Locations that experience frequent changes in air pressure require a higher setting compared to locations where the air pressure is typically stagnant.

15.6 Restore Factory Default

To restore the console to factory default (WiFi network ,Weather server and display), press the MIN/MAX/- key while installing the batteries at the same time. Wait 3 seconds after installing the batteries to let go of the MIN/MAX /- key.

16.Specifications

16.1 Wireless Specifications

- Line of sight wireless transmission (in open air): 100m.
- Frequency: 433 MHz
- Integrated Outdoor transmitter interval: 16seconds

16.2 Measurement Specifications

The following table provides specifications for the measured parameters.

Measurement	Range	Accuracy	Resolution
Indoor Temperature	0 to 60 °C	± 1 °C	0.1 °C
Outdoor Temperature	-40 to 60 °C	± 1 °C	0.1 °C
Indoor Humidity	10 to 99 %	± 5% (only guaranteed between 20 to 90%)	1 %
Outdoor Humidity	10 to 99%	± 5% (only guaranteed between 20 to 90%)	1 %
UV Index	1 to 15+	± 1	± 1
Sunlight	0 to 200klux	± 15%	± 15%
Rain	0 to 9999mm	<15mm:±1 mm, 15mm to 9999mm:±7%	<1000mm (0.3mm) >1000mm (1mm)
Wind Direction	0 - 360 °	± 10° (16 point compass)	± 1° (16 point compass)
Wind Speed	0 to 50 m/s	2 m/s ~10 m/s: ±3m/s, 10m/s ~50 m/s: ±10% (whichever is greater)	0.1 m/s
Barometric Pressure:	300 to 1100 hpa	± 3 hpa	0.1 hpa

16.3 Power Consumption

- Base station (display console) : 3 x AAA 1.5V Alkaline or Lithium batteries (not included)
- Adaptor: 6V~ 500mA (included)
- Integrated Outdoor Transmitter: 3xAAA alkaline batteries or Lithium batteries (not included)
- Battery life: Minimum 12 months for base station with excellent reception. Intermittent reception may reduce the battery life.
Minimum 12 months for Integrated Outdoor Transmitter (use lithium batteries in cold weather climates less than -20 °C), The primary power source is the solar panel. The batteries provide backup power when there is limited solar energy

16.4 WiFi Specifications

1. WIFI Standard: 802.11 b/g/n
2. WiFi Console RF Frequency: 2.4 GHz
3. Setup User Interface (UI) support setup device: Build-in WiFi with WAP mode smart

device, including laptops, computers, smart phones and smart pads.

4. Recommend web browser for setup UI: Web browser support of HTML 5, such as the latest versions of Chrome, Safari, IE, Edge, Firefox or Opera.

5. Line of sight WiFi RF transmission (in open air): 20meter (80 feet)

17.Maintenance

1.Clean the rain gauge of Integrated Outdoor Transmitter once every 3 months.

- Unscrew the rain collector funnel by turning it 30° counter clockwise.
- Gently remove the rain collector funnel.
- Clean and remove any debris or insects.
- Install the collector funnel after it has been cleaned and completely dried.

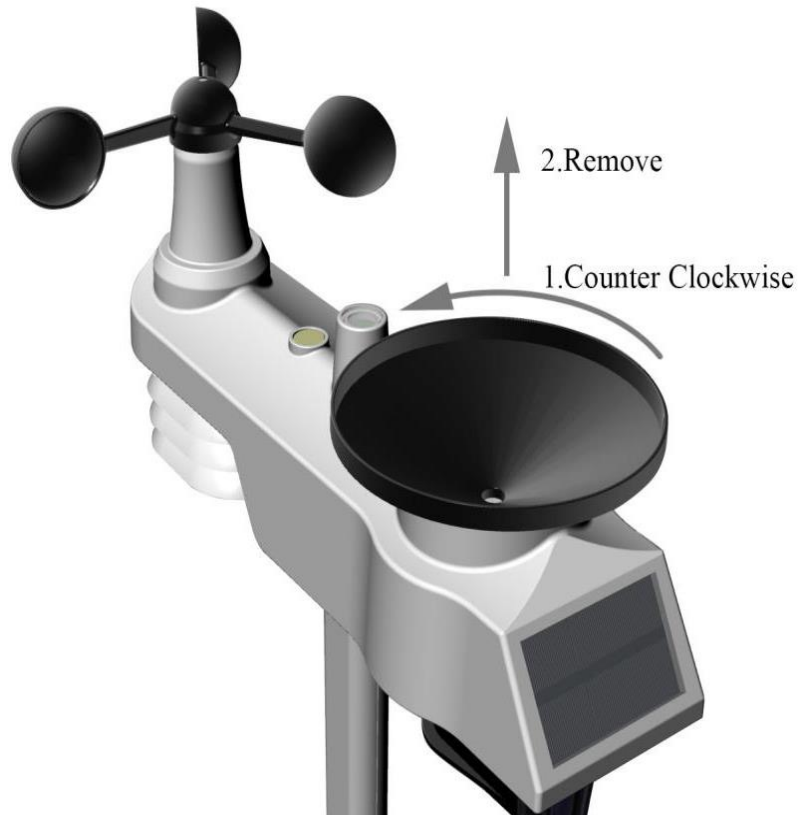

A: Remove the rain collector funnel



B: Install the collector funnel.



Figure 52

2. Replace the Integrated and thermo-hygrometer transmitter batteries once every 1-2 years

18. Troubleshooting Guide.

Problem	Solution
<p>Wireless remote not reporting in to console.</p> <p>There are dashes (---) on the display console.</p>	<p>If any of the sensor communication is lost, dashes (---) will be displayed on the screen. To reacquire the signal, press and hold the CHANNEL/+ button for 3 seconds, choose the lost sensor and the remote search icon 📶 will be constantly displayed. Once the signal is reacquired, the remote search icon 📶 will turn off, and the current values will be displayed.</p> <p>The maximum line of sight communication range is 100 m and 30 m under most conditions. Move the sensor assembly closer to the display console.</p> <p>If the sensor assembly is too close (less than 1.5m), move the sensor assembly away from the display console.</p> <p>Make sure the remote sensor LCD display is working and the transmitter light is flashing once per 60 seconds.</p> <p>Install a fresh set of batteries in the remote thermo-hygrometer. For cold weather environments, install lithium batteries.</p> <p>Make sure the remote sensors are not transmitting through solid metal (acts as an RF shield), or earth barrier (down a hill).</p> <p>Move the display console around electrical noise generating devices, such as computers, TVs and other wireless transmitters or receivers.</p> <p>Move the remote sensor to a higher location. Move the remote sensor to a closer location.</p>
<p>Indoor and Outdoor Temperature do not agree</p>	<p>Allow up to one hour for the sensors to stabilize due to signal filtering. The indoor and outdoor temperature sensors should agree within 2 °C (the sensor accuracy is ± 1 °C).</p> <p>Use the calibration feature to match the indoor and outdoor temperature to a known source.</p>

Problem	Solution
Indoor and Outdoor Humidity do not agree	<p>Allow up to one hour for the sensors to stabilize due to signal filtering. The indoor and outdoor humidity sensors should agree within 10 % (the sensor accuracy is ± 5 %).</p> <p>Use the calibration feature to match the indoor and outdoor humidity to a known source.</p>
Display console contrast is weak	Replace console batteries with a fresh set of batteries.
WiFi does not display on console.	<p>Check your router for problems.</p> <ol style="list-style-type: none"> 1. Check WiFi symbol on the display. If wireless connectivity is successful the WiFi icon  will be displayed in the time field. 2. Make sure your modem WiFi settings are correct (network name, and password). 3. Make sure the console is plugged into AC power. The console will not connect to WiFi when powered by batteries only. 4. The console only supports and connects to 2.4 GHz routers. If you own a 5 GHz router, and it is a dual band router, you will need to disable the 5 GHz band, and enable the 2.4 GHz band. 5. The console does not support guest networks.

Problem	Solution
<p>Data not reporting to www.wunderground. com or www.weathercloud.net</p>	<ol style="list-style-type: none"> 1. Confirm your password or key is correct. It is the password you registered on Wunderground.com. Your Wunderground.com password cannot begin with a non-alphanumeric character (a limitation of Wunderground.com, not the station). Example, \$worknet is not a valid password, but worknet\$ is valid. 2. Confirm your station ID is correct. 3. Make sure the date and time is correct on the console. If incorrect, you may be reporting old data, not real time data. 4. Make sure your time zone is set properly. If incorrect, you may be reporting old data, not real time data. 5. Check your router firewall settings. The console sends data via Port 80.



LUCID-Reg.-Nr. : DE5447971723326