

# SOIL RESISTIVITY TESTER

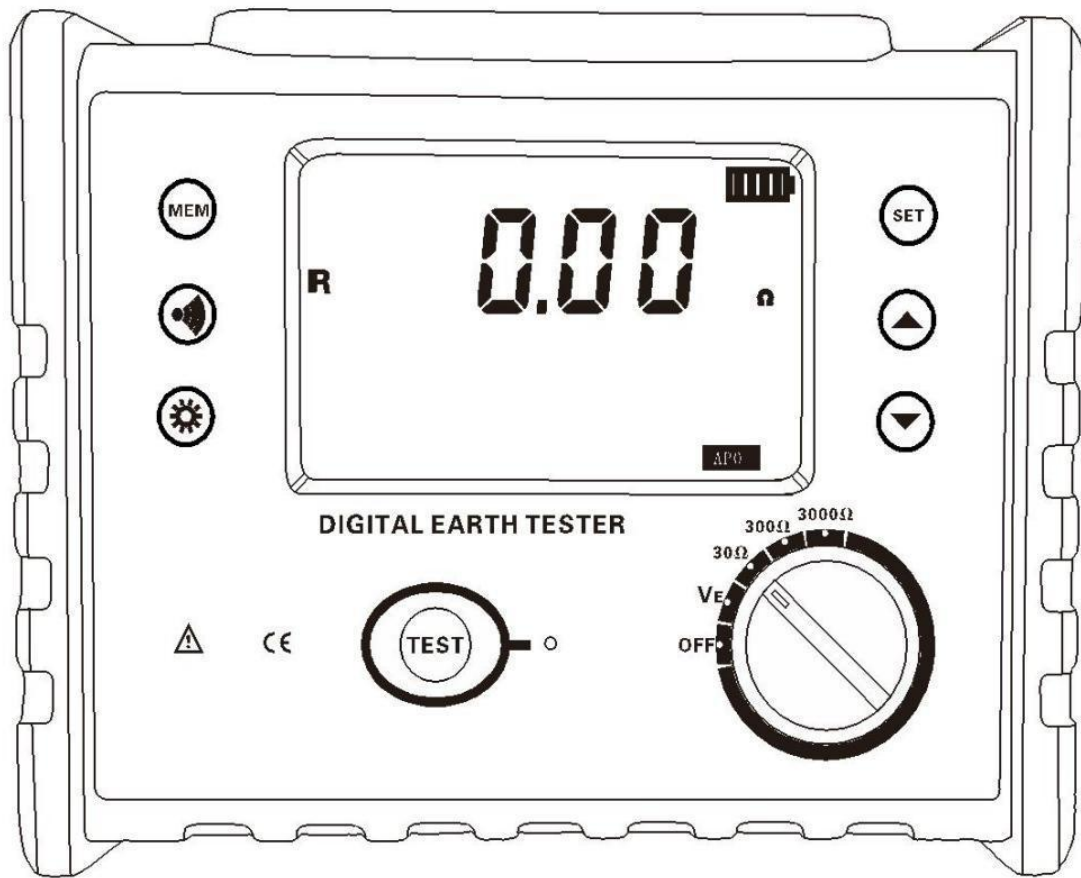

## FR3010E USER MANUAL

---

# CONTENT



I. Safety Rules and Precautions .....	2
II. Introduction .....	3
III. Measuring Range and Accuracy .....	4
IV. Technical Specifications .....	5
V. Tester Structure .....	7
VI. Measuring Principle .....	8
VII. Operation Methods .....	9
1. Switch On/Off .....	9
2. Battery Voltage Check .....	9
3. Ground voltage Measurement .....	9
4. Wire Resistance Verification .....	10
5. Four-wire Precision Test Ground Resistance .....	11
6. Three-wire Test Grounding Resistance .....	13
9. Backlight Control .....	16
10. Alarm Settings .....	16
11. Data Lock/Storage .....	17
12. Data Review/Deletion .....	17
IX. Battery Replacement .....	18
X. Accessories .....	18

# I. Safety Rules and Precautions

Thanks for your purchase of **Ground Resistance Soil Resistivity Tester** of our company. Before you use the instrument for the first time, in order to avoid possible electric shock or personal injury, please be sure to: **read and strictly observe the safety rules and precautions listed in this manual.**

Under any circumstance, it shall pay special attention on safety in use of this tester

- ◆ The tester is conforming to IEC61010 on design, production and test.
- ◆ Under any circumstance, it shall pay special attention on safety in use of this tester.
- ◆ Please don't use high-frequency signal generators like mobile phone and etc. to avoid error during measuring.
- ◆ Pay attention to words and symbols stick on the Tester.
- ◆ It shall make sure that tester and accessories are in good condition before use; it can be used only when there is no damaged, naked or broken part in testing wires or insulation layer.
- ◆ During measurement, it is forbidden to touch bare conductors and circuit under measurement.
- ◆ Confirm that connector plug of lead has been inserted in the tester interface closely.
- ◆ Please don't impose over 600V A.C. or D.C. voltage on the part between testing end and interface. Otherwise, it may have damage on the tester.
- ◆ Please don't measure in an inflammable place. The flame sparkle maybe cause explosion.

- ◆ During usage of tester, please stop using it when exposed metal is caused by broken enclosure or testing wires.
- ◆ Please don't keep or store the tester in the spot with high-temperature and moisture, or condensation, and under direct daylight radiation for a long time.
- ◆ For replacing battery, please confirm testing wire has moved apart the meter, and FUNCTION SWITCH rotary switch is in "OFF" position.
- ◆ Please put the used batteries in appointed collection place.
- ◆ When replacing the battery with the meter, make sure that the test line has been removed from the meter and the meter is turned off.
- ◆ When the meter displays battery low voltage symbol "", and need to replace the battery in time.
- ◆ Pay attention to measuring range and usage environment stipulated for the Tester.
- ◆ This measuring device is only to be used, disassembled, adjusted and repaired by qualified personnel with authorization.
- ◆ When it may cause hazard by continuous use for the reason of the Tester itself, it shall immediately stop using it and deposit it at once, leaving it for disposal by authorized agency.
- ◆ For risk of danger icon in manual "", users must perform safety operations strictly in compliance with the manual content.

## II. Introduction

**Ground Resistance • Soil Resistivity Tester** also known as **Four-Wire Ground Tester, Precision Ground Resistance Tester**, etc. It is a commonly used meter for measuring grounding resistance. It adopts a large LCD gray-white screen backlight display and microprocessor technology to meet the requirements of two-wire, three-wire and four-wire test resistance and soil

resistivity test. **Suitable for telecommunications, electricity, meteorology, computer rooms, oil fields, power distribution lines, iron tower transmission lines, gas stations, factory grounding networks, lightning rods and so on. Instrument testing is precise, fast, simple, stable and reliable.**

The **Ground Resistance • Soil Resistivity Tester** is controlled by the microprocessor and can automatically detect the connection status of each interface and the interference voltage and interference frequency of the ground network, and has the function of testing the auxiliary grounding resistance value. At the same time store 500 sets of data, **resistance measurement range: 0.01 Ω ~ 30.00k Ω , grounding voltage range: 0.01 ~ 600.0V**

### III. Measuring Range and Accuracy

Category	Measurement Range	Intrinsic Error	Resolution
<b>Earth Resistance (R)</b>	0.00Ω-30.00Ω	±2%rdg±5dgt	0.01Ω
	30.0Ω-300.0Ω	±2%rdg±3dgt	0.1Ω
	300Ω-3000Ω	±2%rdg±3dgt	1Ω
	3.00kΩ-30.00kΩ	±4%rdg±3dgt	10Ω
<b>Soil Resistivity (ρ)</b>	0.00Ωm-99.99Ωm	ρ=2πaR (remark 2)	0.01Ωm
	100.0Ωm-999.9Ωm		0.1Ωm
	1000Ωm-9999Ωm		1Ωm
	10.00kΩm-99.99kΩm		10Ωm
	100.0kΩm-999.9kΩm		100Ωm
	1000kΩm-9999kΩm		1kΩm
<b>Earth Voltage</b>	AC 0.00-600V	±2%rdg±3dgt	0.01V

Remark:1. Reference conditions: Accuracy when  $R_h R_s < 100 \Omega$ .

Operating conditions:  $R_h \max = 3k \Omega + 100R < 50k \Omega$ ;  $R_s \max = 3k \Omega + 100R < 50k \Omega$

2. Depending on the measurement accuracy of R,  $\pi = 3.14$ , a: 1 m ~ 100m;

## IV. Technical Specifications

<b>Function</b>	Two, three, four-wire measure grounding resistance, soil resistivity; Ground voltage, AC voltage
<b>Ambient temperature and humidity</b>	23°C ± 5°C, below 75%rh
<b>Power Supply</b>	DC 9V 6-section LR14 Dry Battery Standby for more than 100 hours
<b>Interference voltage</b>	<20V(should be avoided)
<b>Interference current</b>	<2A (should be avoided)
<b>Measure R electrode spacing</b>	a>5d
<b>Measured electrode spacing</b>	a>20h
<b>Auxiliary Earth Resistance</b>	Reference Conditions <100 Ω , Operating Conditions <5k Ω
<b>Range</b>	Grounding resistance: 0.00 Ω to 30.00k Ω
	Soil resistivity: 0.00 Ω m ~ 9999k Ω m
	Ground voltage: 0.00V to 600.0V
<b>Measurement Method</b>	Precision 4-wire, 3-wire measurement, simple 2-wire grounding resistance
<b>Measuring Methods</b>	Grounding resistance: rated current change method Soil resistivity: four-pole method Ground voltage: average rectification ( <b>S-ES</b> interface)
<b>Test Frequency</b>	128Hz
<b>Short-circuit Test Current</b>	AC >20mA (sine wave)
<b>Open Circuit Test Voltage</b>	AC 28V max
<b>Electrode Spacing Range</b>	can be set from 1m to 100m
<b>Change Gear</b>	Grounding resistance: fully automatic shifting from 0.00 Ω to 30.00k Ω
	Soil resistivity: 0.00 Ω m ~ 9000k Ω m automatic shifting
<b>Backlight</b>	Gray screen backlight, suitable for dim places

<b>Display Mode</b>	4-digital super-large LCD display, blue screen backlight
<b>Measuring Indicator</b>	During measurement, LED flash
<b>LCD Frame Dimension</b>	111mm×65mm
<b>LCD display area</b>	108mm×65mm
<b>Dimension</b>	L×W×H: 240mm×188mm×85mm
<b>Standard Test Wire</b>	4 wires: each for red 20m, black 20m, yellow 10m, and green 10m
<b>Simple Test Wire</b>	2 wires: each for yellow 1.5m and green 1.5m
<b>Auxiliary Earthing Rod</b>	4 PCS
<b>Measuring Rate</b>	Voltage to ground: about 3 times/second Earth resistance, soil resistivity: about 7 seconds/time
<b>Circuit Voltage</b>	below AC 600V(The ground voltage measurement function cannot be used to measure commercial power)
<b>Data Storage</b>	500 sets, “MEM” icon storage indicator, flash display “FULL” icon to indicate storage is full
<b>Data Read</b>	Data read function: “MR” icon display
<b>Overflow Display</b>	Exceeding measuring range overflow function: “OL” icon display
<b>Alarm Function</b>	Alarm when the measured value exceeds the alarm setting value
<b>Battery Voltage</b>	Low battery voltage symbol display
<b>Automatic Shut-down</b>	"APO" instruction, automatically shut down after 15 minutes of power on
<b>Power Consumption</b>	Standby: About 40mA (backlight off) Turn on and backlight on: about 43mA Measurement: about 75mA (backlight off)
<b>Weight</b>	Tester: 1230g (including battery) Testing Wires: 1300g Auxiliary earthing rod: 720g(4 PCS)
<b>Working Temperature &amp; Humidity</b>	-10℃~40℃; below 80%rh

<b>Storage temperature &amp; humidity</b>	-20°C~60°C; below 70%rh
<b>Overload Protection</b>	Measuring earth ground resistance: between each interfaces of <b>H-E</b> 、 <b>S-ES</b> , AC 280V/3 seconds
<b>Insulation Resistance</b>	Over 20MΩ(between circuit and enclosure it is 500V)
<b>Withstanding Voltage</b>	AC 3700V/rms (Between circuit and enclosure)
<b>Electromagnetic Features</b>	IEC61326(EMC)
<b>Protection Type</b>	IEC61010-1 (CAT III 300V, CAT IV 150V, Pollution Degree 2); IEC61010-031; IEC61557-1 (grounding resistance); IEC61557-5 (soil resistivity); JJG 366-2004

## V. Tester Structure

1. LCD
2. H interface: Current electrode
3. S interface: Voltage electrode
4. ES interface: Auxiliary earth electrode
5. E interface: Earth electrode
6. Function Button
7. Rotary switch for gear selection
8. Test button
9. Safety alligator clip
10. Standard test wires
11. Auxiliary earthing rods

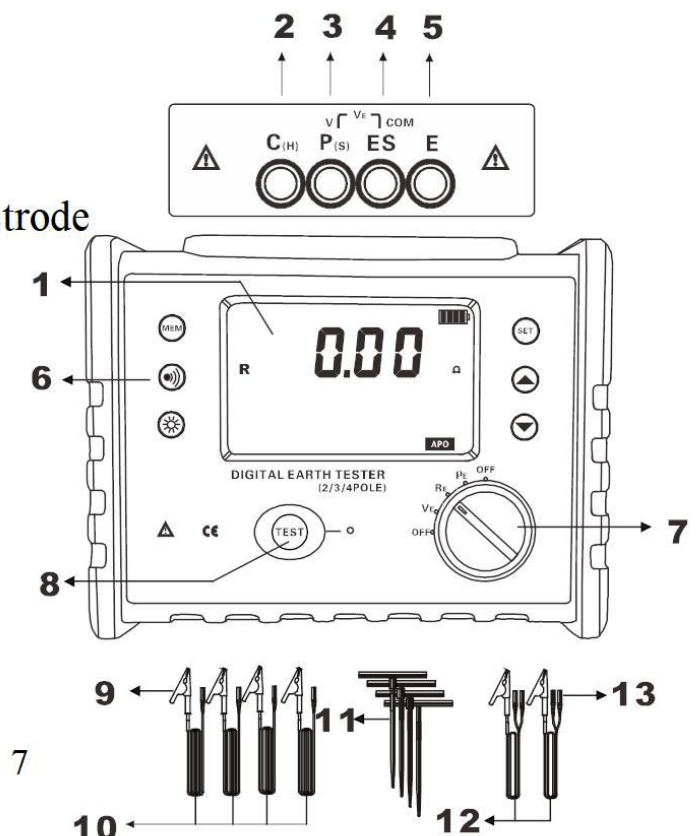



12. Simple test wires

13. Interface of testing wires

## VI. Measuring Principle

1. Ground voltage measurement uses average rectification.

2. The grounding resistance measurement adopts the rated current change pole method, that is, the alternating current rated current  $I$  flowing between the measuring object **E ground electrode** and the **H current electrode**, to obtain the potential difference  $V$  of the **E ground electrode** and **S voltage electrode**, and according to the formula  $R=V/I$  Calculate the ground resistance value  $R$ . In order to ensure the accuracy of the test, a four-wire method was designed to increase the **ES auxiliary ground**. During actual testing, **ES** and **E** were clamped at the same point of the grounding body. The four-wire test can eliminate the influence of the contact resistance (usually dirt or rust) on the measured grounding body, auxiliary grounding rod, test clip, and the input interface of the instrument to the measurement, and can eliminate the influence of the wire resistance on the measurement, more precision.

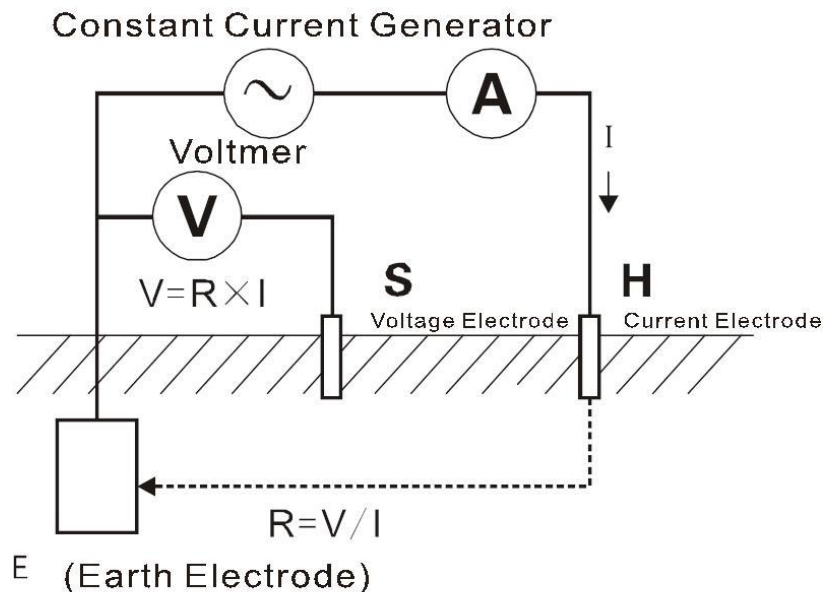

3. It's operating error( $B$ ) is an error obtained within the rated operating conditions, and calculated with the intrinsic error( $A$ ) and the error( $E_i$ ) due to variations.

$$B = \pm (|A| + 1.15 \times \sqrt{(E_1^2 + E_2^2 + E_3^2 + E_4^2 + E_5^2 + E_7^2 + E_8^2)})$$

**A:** Intrinsic error

**E2:** Variation due to power supply voltage

**E3:** Variation due to temperature change

- E4: Variation due to interference voltage change
- E5: Variation due to contact electrode resistance

4. The soil resistivity ( $\rho$ ) is measured using the 4-pole method (Winner method): the alternating current  $I$  flows between the **E ground electrode** and the **H current electrode**, and the potential difference  $V$  between the **S voltage electrode** and the **ES auxiliary ground electrode** is calculated. The potential difference  $V$  is divided by the alternating current  $I$  obtains the grounding resistance value  $R$ , the electrode spacing distance is  $a(m)$ , and the soil resistivity value is obtained according to the formula  $\rho = 2\pi aR(\Omega m)$ , and the distance between the **H-S** pitch and the **S-ES** is equal (both  $a$ ), that is Winner method. For ease of calculation, please make the electrode spacing  $a$  much larger than the buried depth  $h$ , generally should meet  $a > 20h$ , see the figure below.

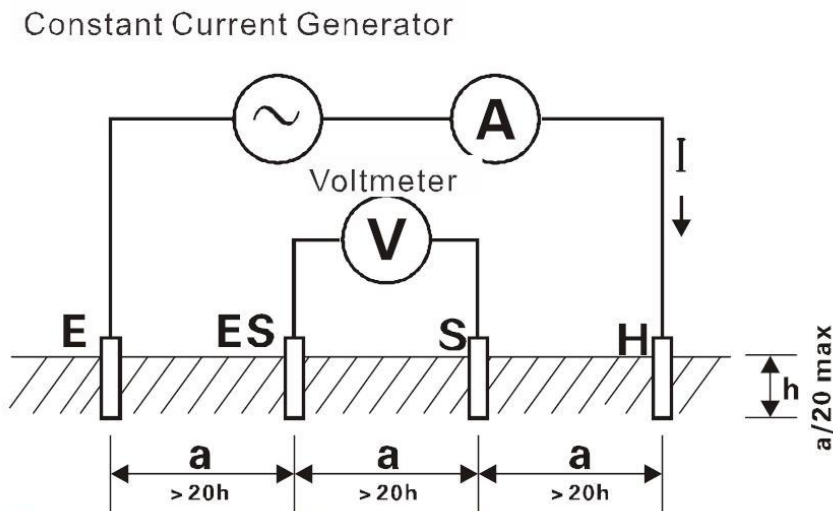

## VII. Operation Methods

### 1. Switch On/Off

Turn the function key to the corresponding test position and turn it on. Turn the function key to the OFF position to turn off the instrument. After power on, there is "APO" displayed in the lower corner. If it is not operated, it will be automatically turned off after 15 minutes.

### 2. Battery Voltage Check

After switch on, if LCD displays low battery voltage icon "  ", which indicates that battery voltage is low, and please replace the battery in time.

### 3. Ground voltage measurement

	One auxiliary grounding rod is required for the ground voltage test.
	As long as the instrument is connected to the ground through the test wire and the auxiliary grounding rod, the other test wires of the

	instrument interface cannot be connected to the L and N wires of the commercial power supply. Otherwise, the leakage may occur, and the circuit breaker may start up and be dangerous.
	Ground voltage test cannot exceed 600V.

Grounding voltage: when the ground fault of the electrical equipment occurs, the potential difference between the grounding device casing, the grounding wire, the grounding body and the zero potential point, the grounding voltage is the reference point of the ground, the potential difference from the earth, and the earth is zero potential point.

An auxiliary grounding rod is required for the ground voltage test. Note the difference from the commercial AC voltage test. See the following figure: After the meter, auxiliary grounding rod, and test line are all connected, after turning on the power, turn the function selection key to U. The LCD shows the test result.

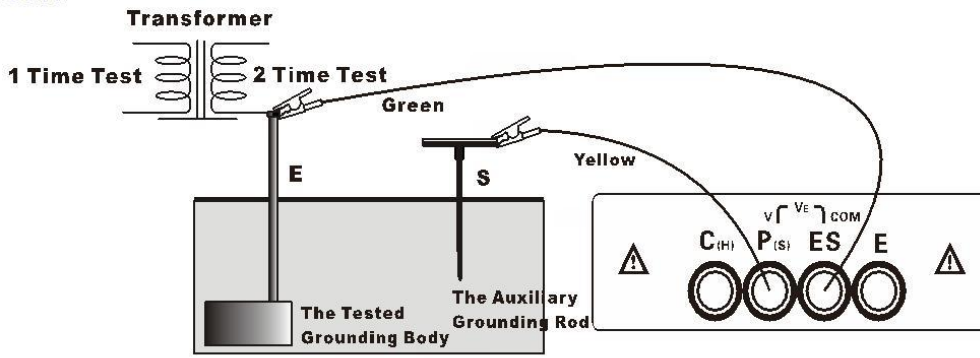

**Commercial Grounding Body To Ground Voltage Test**

## 4. Wire Resistance Verification

In order to improve precision and stability of field measurement of earth ground resistance, avoid error due to wire resistance change due to prolonged usage of testing wires; avoid error due to testing wire that is failed to be fully inserted into tester interface or by poor contact; avoid error due to users' replacing or lengthening testing wires and etc., wire resistance verification is specially designed, which is more accurate on low value resistance measurement.

As shown in the figure below, press the function button **R** button to switch to the corresponding ground resistance measurement position, press **▲** button to start verification. During verification, During the calibration, the LED indicator flashes. The LCD counts down. After the calibration is completed, the LCD displays the line resistance and stores the value. The checked line resistance value is automatically deducted from this start-up ground resistance measurement.

Shutdown does not save the calibration line resistance. The next time you turn on the power, you need to verify again.

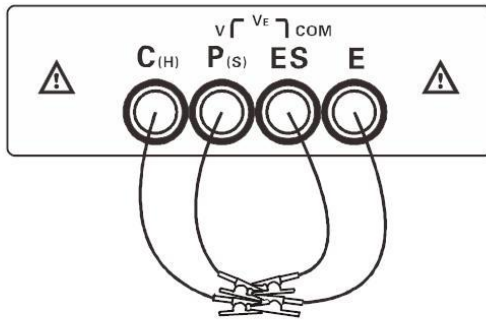

## 5. Four-wire Precision Test Ground Resistance

	<p>When testing the grounding resistance, first confirm the grounding voltage of the grounding wire, that is, the voltages of H and E or S and ES must be less than 20V. If the grounding voltage is more than 5V, the measured value of the grounding resistance may be inaccurate. At this time, the measured grounding device should be powered off first, so that the grounding voltage is reduced and then the grounding resistance test is performed.</p>
---	---

Four-wire test: The four-wire test eliminates the influence of the contact resistance (usually dirt or rust) on the measured grounding body, auxiliary grounding bar, test clip, and the input interface of the instrument to the measurement, eliminating the effect of the wire resistance to the measurement. It is better than the three-line test.

See the following figure: Beginning with the measured object, generally spaced 5m ~ 20m, respectively, the **S**, **H** auxiliary grounding rod is buried deep into the ground in a straight line, the ground test line (black, green, yellow, red) from the instrument **E**, **ES**, **S**, and **H** interfaces are initially connected to the ground electrode **E** under test, the auxiliary voltage electrode **S**, and the auxiliary current electrode **H**.

	<p>The distance between the measured grounding body <b>E</b> and the current pole <b>H</b> should be at least 5 times the buried ground depth (<math>h</math>) of the measured grounding body, or 5 times the buried ground electrode length (<math>d</math>).</p>
	<p>Measure the total grounding resistance of a complex grounding system. The distance <math>d</math> is the distance of the largest diagonal of the grounding system.</p>
	<p>During the test, the test leads cannot be intertwined with each other. Otherwise, the test accuracy may be affected.</p>

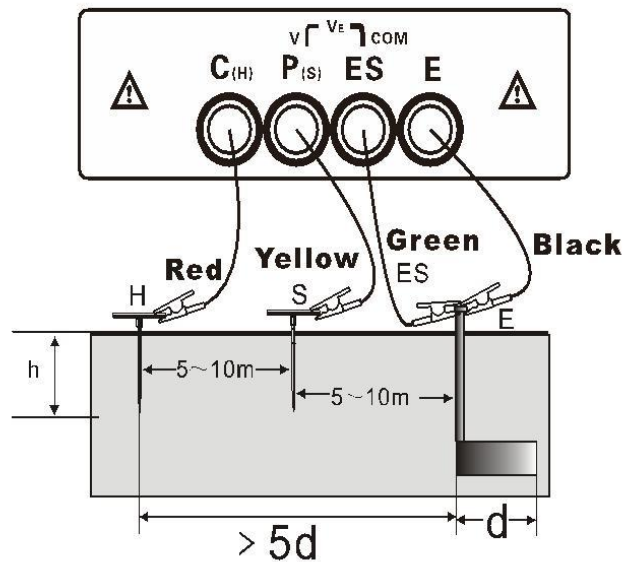

For a multi-point independent grounding system or a geodetic grounding system, the user can choose a longer test line, and the electrode spacing is greater than 5 times the maximum diagonal length of the tested network. As shown below:

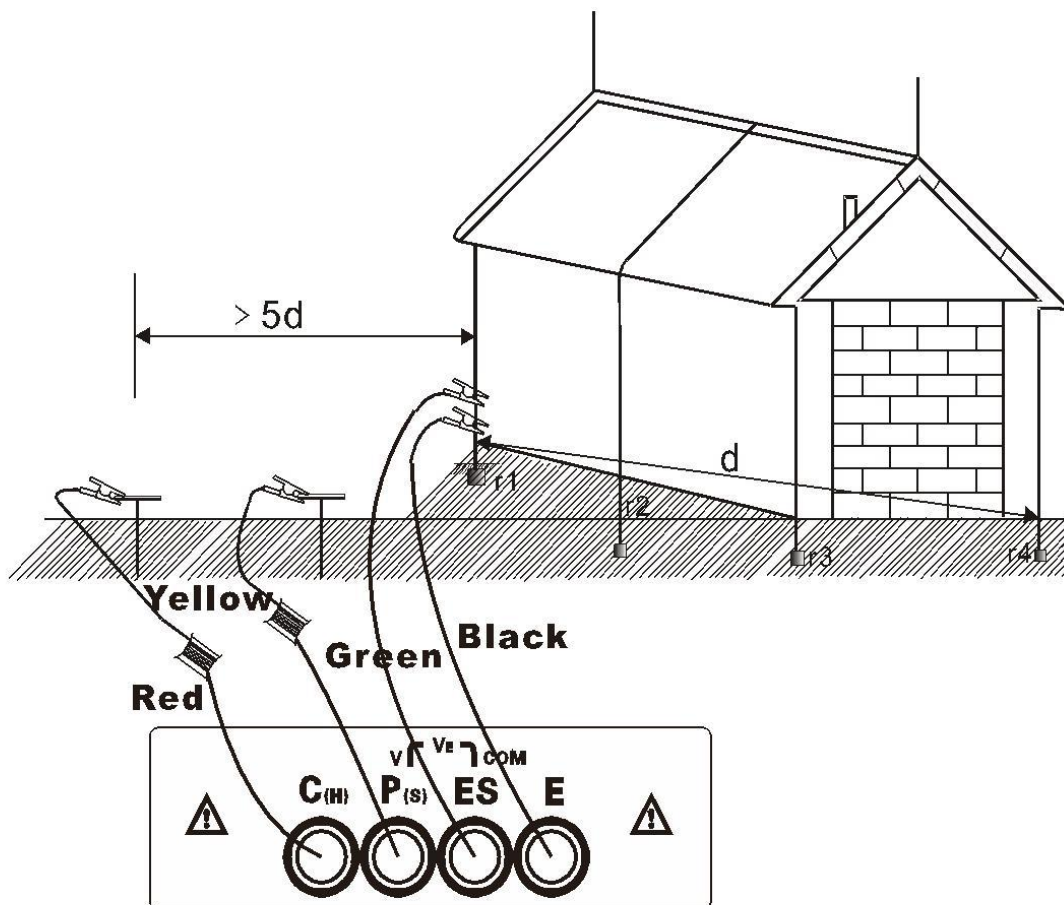

$R=r_1 // r_2 // r_3 // r_4 // r_5 // r_6 // \dots // r_n$  ( $r_1\dots r_n$  are all independent earth points)

$R$  — — meter readings, total grounding resistance of the entire grounding system;

$R_1\dots r_n$  - are all independent grounding points, and grounding bodies are not connected together under the ground;

$R_H$ —ground resistance of auxiliary current pole  $H$ ;

$R_S$  - ground resistance of auxiliary voltage pole  $S$ ;

$n$  - the number of independent grounding points, the more points, the smaller the  $R$  value.

## 6. Three-wire Test Grounding Resistance

Three-wire test: As shown in the figure below, short-circuit the  $ES$  and  $E$  interfaces of the instrument, that is, the three-wire test, and the instrument operation is the same as the four-wire test. The three-wire test can not eliminate the influence of the wire resistance on the measurement, nor can it eliminate the influence of the change of the contact resistance between the instrument and the test wire and between the test wire and the auxiliary grounding rod, and the oxide layer on the surface of the ground body to be measured needs to be removed.

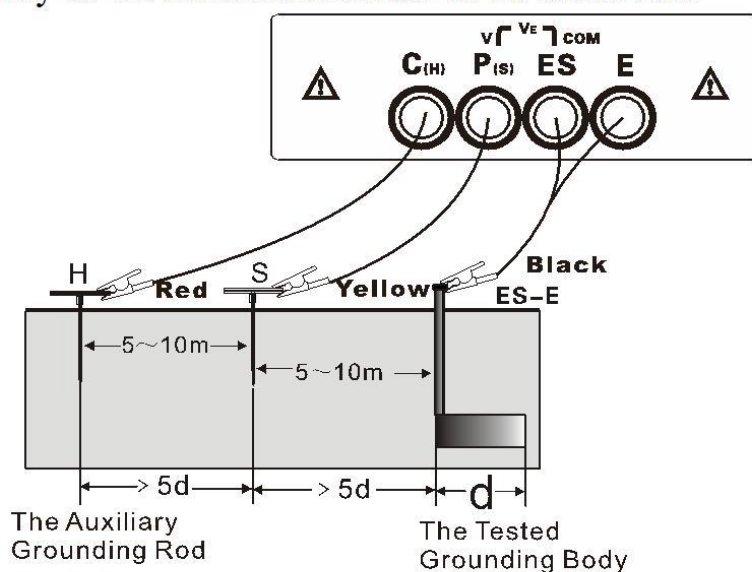

## 7. Two-wire easy Test Grounding Resistance

Second-line test: This method is a simple measurement method that does not use the auxiliary grounding rod. It uses the existing grounding electrode with the smallest value of the grounding resistance as the auxiliary grounding electrode, and uses two simple test lines to connect the **H-S** interface and the **E-ES** interface. ). The auxiliary ground rods **H** and **S** may be replaced with metallic ground pipes such as metal water pipes and fire hydrants, common grounding of commercial power systems, or lightning protection grounds of buildings, etc., and the oxide layer of the connection points of the selected metal auxiliary grounding body should be removed during measurement. Floor. Wiring as shown below, the instrument operation with the four-wire test.

	<p>When using the commercial power system grounding as an auxiliary grounding pole measurement, it must be confirmed that it is the grounding pole of a commercial power system. Otherwise, the circuit breaker may start up and be in danger.</p>
	<p>Use a simple two-wire method to measure the grounding resistance, and try to select the grounding body with a small re value as the auxiliary grounding electrode so that the meter reading is closer to the true value. When measuring, please select the metal water pipe and metal fire hydrant as the auxiliary grounding electrode.</p>

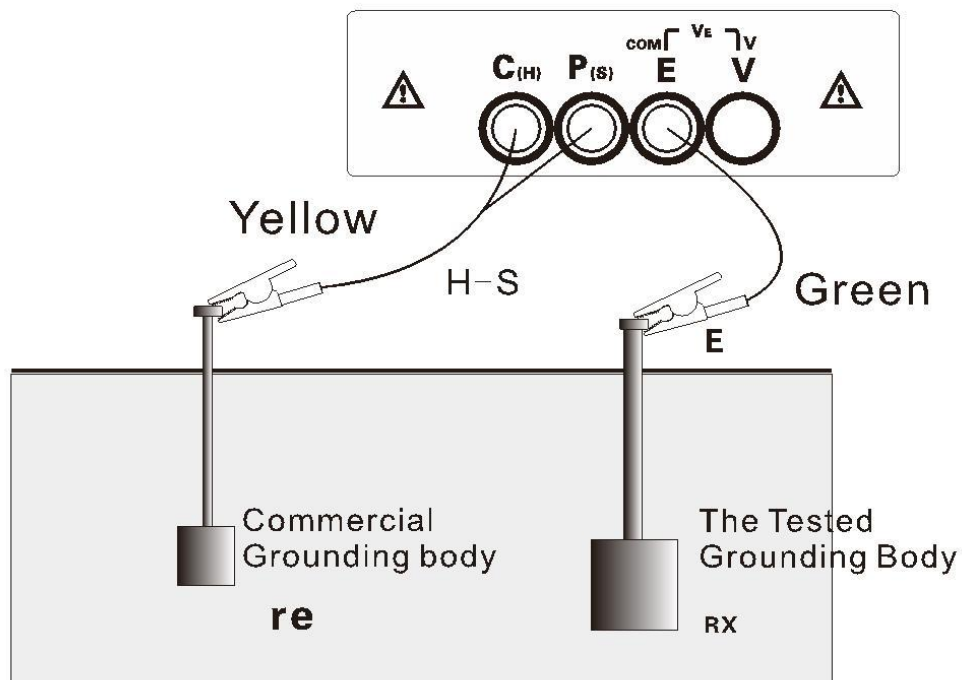

Two-wire easy Test Grounding Resistance its reading on Tester is the total value of earth ground resistance value of measured earthing object and

that of commercial earthing object, namely:

$$RE = RX + re$$

In which: **RE** is the Tester reading value;

**RX** is the earth ground resistance value of measured earthing object;

**re** is the earth ground resistance value of common earthing object like commercial use power system.

Then, the earth ground resistance value of measured earthing object is:  
 **$RX = RE - re$**

## 8. Soil Resistivity Test

The soil resistivity  $\rho$  is an important factor that determines the grounding resistance of the grounding body. Different types of soil, of course, have different soil resistivities, that is, even the same kind of soil, because of different temperature and moisture content, the soil resistivity will also change significantly. Therefore, in order to have a correct basis in the design of the grounding device, so that the designed grounding device can more meet the actual needs of the work, the soil resistivity must be measured.

The soil resistivity was measured by the four-pole method (Winner method).

The soil resistivity  $\rho$  is calculated according to the formula  $\rho = 2\pi aR$  ( $\Omega m$ ), and the unit is  $\Omega m$ , and:

**a** - electrode spacing

**R**——Soil resistance between **S-ES** electrodes

Four-pole method (Winner method): Connect the test wire as shown below. Pay attention to the space between the auxiliary grounding rods and the depth of burial. **H**, **S**, **ES**, and **E** auxiliary ground rods are buried in the ground and buried deep into the earth. The ground test lines (red, yellow, green, and black) are connected from the **H**, **S**, **ES**, and **E** ports of the meter to the **H**, **S**, **ES**, and **E** auxiliary ground bars under test.



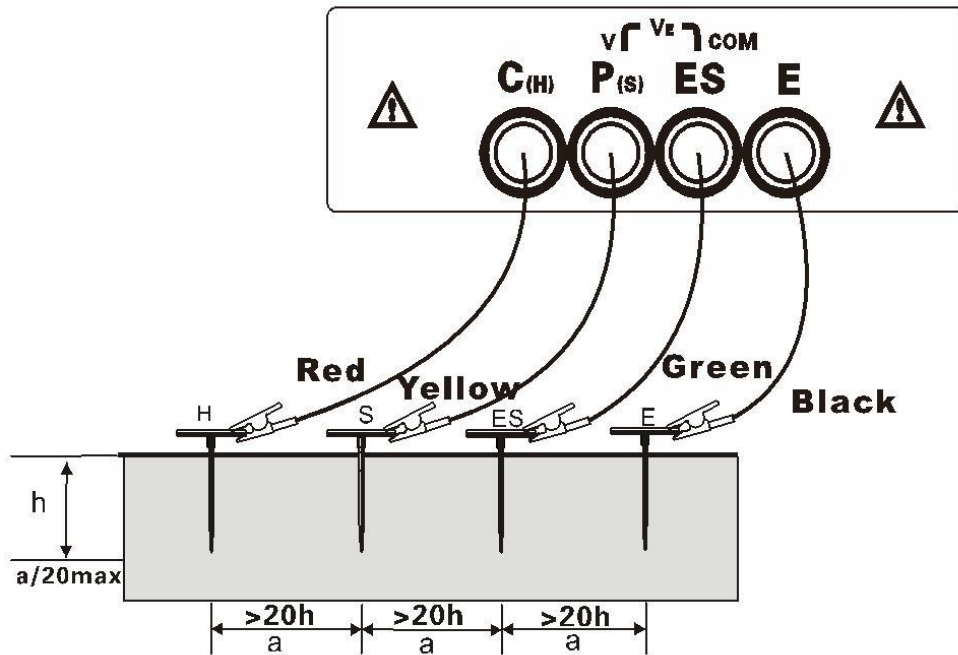

Auxiliary grounding rod spacing setting: After connecting the test line, press the function button  $\rho$  to enter the soil resistivity test mode, press and hold the **SET** button (more than 3 seconds) to enter the spacing setting of the auxiliary grounding rod, press the “●)”) key shortly to move the cursor, press “▲” or “▼” key to change the current number size (a value range: 1m ~ 100m), and then press the **SET** key (more than 3 seconds) to save the set a value, and return to the soil resistivity test mode



After the value of *a* is set, in the soil resistivity test mode, press the “**TEST**” key to start the test and count down to display the test progress. After the test is completed, a stable soil resistivity value is displayed.

## 9. Backlight Control

After startup, press “☀” button to turn on or off backlight. The backlight function is suitable to dark spot. It will default backlight turn-off for each startup.

## 10. Alarm Settings

After power on, short press “🔔”)” to turn on and off the alarm function. Short press “SET” key to set the resistance alarm value, press “🔔”)” key to move the cursor, press “▲” or “▼” key to change the current size, and then press “SET” key to save and exit. When the measured value is greater than the alarm critical setting value and the alarm function is turned on, the meter displays the “🔔”)” symbol and issues a “beep-beep-beep--” alarm sound. The maximum value of the ground voltage alarm setting is 100V, the maximum value of the ground resistance alarm setting is 3000  $\Omega$ , and the maximum value of the soil resistivity alarm setting is 9999  $\Omega$  m. As shown below:



## 11. Data Lock/Storage

Startup or after measurement, press “MEM” button to lock current displayed data, showing “MEM” icon and automatically store with serial numbers. If storage is full, the Tester will display “FULL” icon. To remove lock. As shown in figure below: the lock measurement data is 1032 $\Omega$ , press “MEM” button save as the 3th group of data.

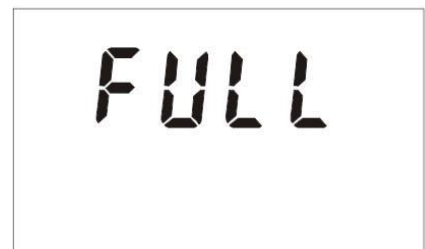

## 12. Data Review/Deletion

Startup or after measurement, press “MEM” button for a longer time (over 3 seconds) to enter data reading, the interface corresponding to the stored

data interface and the stored data group number flash alternately. Press ▲ or ▼ button to select reading data group number by step value 1, press ▲ or ▼ button constantly to select reading data group number by step value 5, and then press “MEM” button to exit from reading.

In the figure below, the number 3 is the current group number, and 6 is the total group number, LCD will display “NULL”, see the above figure.



Under data reading status, press SET button to enter data deletion, press ▲ or ▼ to select “NO” or “YES”, selecting “NO” and then pressing SET button for not deleting and return data reading status, selecting “YES” and then pressing SET button for deleting stored data and it will show as above right figure after deletion.

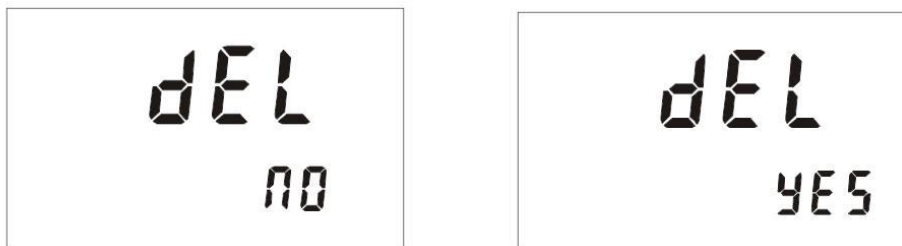

## IX. Battery Replacement

The instrument uses 9V 6-section LR14 dry cell battery, when the battery power is reduced, the power indicator bar is reduced. When the voltage drops to 5V, the battery symbol “” is displayed. Please replace the battery in time. Low voltage affects the measurement accuracy.

## X. Accessories

Tester	1 PC
Tester Box	1 PC
Auxiliary Earthing Rod	4 PCS
Testing Wire	4 PCS
Simple testing wire	2 PCS

1.5V battery	6 PCS
Manual , Qualification Certificate	1 SET

The contents of this user manual should not be used as a reason to use the product for a special purpose.

The company is not responsible for other losses caused by use.

The company reserves the right to modify the contents of the user manual.  
Subject to modification without further notice.



GuangZhou ZhengNeng Electronics Technology Co.LTD

Address: 4th Floor, No. 771, Guangcong Eighth Road, Changyaoling  
Village, Zhongluotan Town, Baiyun District, Guangzhou, China

Tel: 86-20-36544172

E-mail: [hsh@znele.com](mailto:hsh@znele.com)

Post: 510540

WebSite: [www.fuzrr.com](http://www.fuzrr.com)