

Digital Ground Resistance Tester

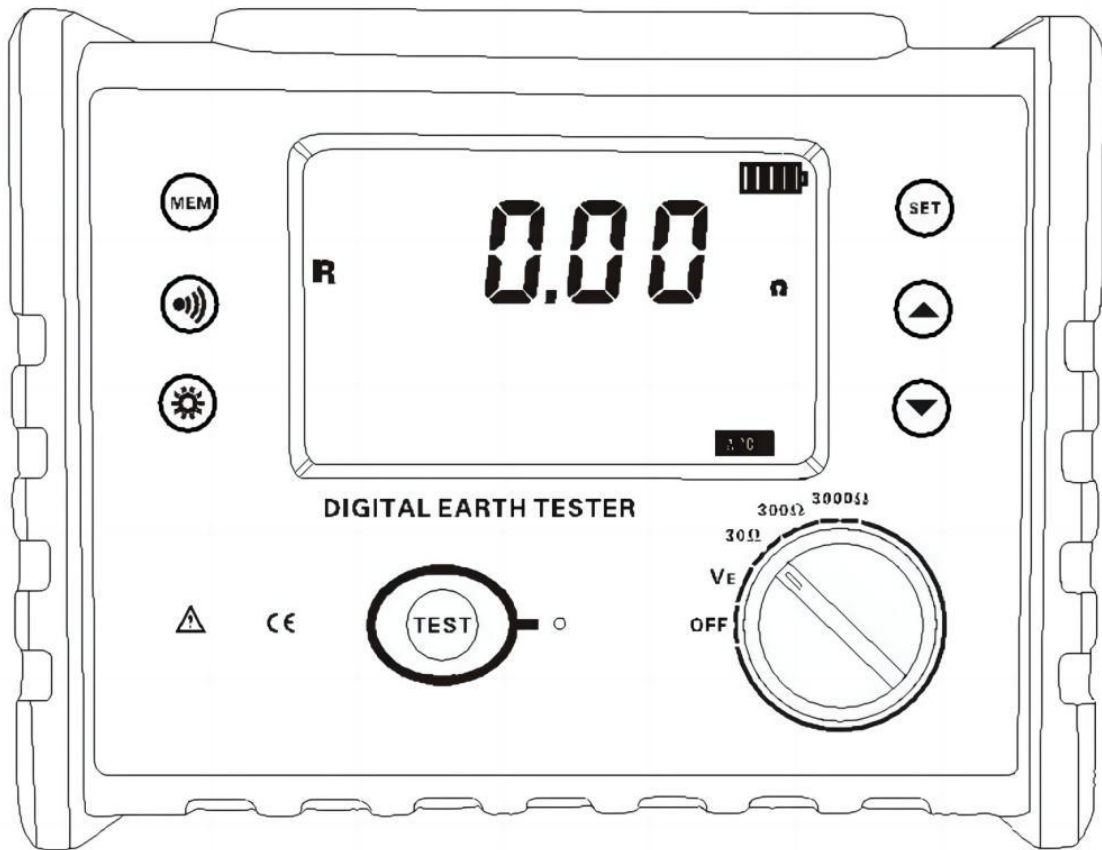

FR3010 USER MANUAL

CONTENT



I. Safety Rules and Precautions	2
II. Introduction	3
III. Measuring Range and Accuracy	4
IV. Technical Specifications	5
V. Tester Structure	7
VI. Measuring Principle	7
VII. Function Quick Check	8
VIII. Operation Methods	9
1. Switch On/Off	9
2. Battery Voltage Check	9
3. Ground voltage measurement	9
4. Wire Resistance Verification	10
5. Grounding Resistance Precision Measurement	10
6. Simple Method for Measuring Ground Resistance	11
7. Backlight Control	12
8. Alarm Settings	13
9. Data Lock/Storage	13
10. Data Review/Deletion	13
IX. Battery Replacement	14
X. Accessories	14

I. Safety Rules and Precautions

Thanks for your purchase of **Digital Earth Resistance Tester** of our company. Before you use the instrument for the first time, in order to avoid possible electric shock or personal injury, please be sure to: **read and strictly observe the safety rules and precautions listed in this manual.**

Under any circumstance, it shall pay special attention on safety in use of this tester

- ◆ The tester is conforming to IEC61010 on design, production and test.
- ◆ Under any circumstance, it shall pay special attention on safety in use of this tester.
- ◆ Please don't use high-frequency signal generators like mobile phone and etc. to avoid error during measuring.
- ◆ Pay attention to words and symbols stick on the Tester.
- ◆ It shall make sure that tester and accessories are in good condition before use; it can be used only when there is no damaged, naked or broken part in testing wires or insulation layer.
- ◆ During measurement, it is forbidden to touch bare conductors and circuit under measurement.
- ◆ Confirm that connector plug of lead has been inserted in the tester interface closely.
- ◆ Please don't impose over 600V A.C. or D.C. voltage on the part between testing end and interface. Otherwise, it may have damage on the tester.
- ◆ Please don't measure in an inflammable place. The flame sparkle maybe cause explosion.

- ◆ During usage of tester, please stop using it when exposed metal is caused by broken enclosure or testing wires.
- ◆ Please don't keep or store the tester in the spot with high-temperature and moisture, or condensation, and under direct daylight radiation for a long time.
- ◆ When replacing the battery of the meter, make sure that the test leads are removed from the meter and the meter is turned off.
- ◆ Please put the used batteries in appointed collection place.
- ◆ When replacing the battery with the meter, make sure that the test line has been removed from the meter and the meter is turned off.
- ◆ When the meter displays battery low voltage symbol “”, and need to replace the battery in time.
- ◆ Pay attention to measuring range and usage environment stipulated for the Tester.
- ◆ This measuring device is only to be used, disassembled, adjusted and repaired by qualified personnel with authorization.
- ◆ When it may cause hazard by continuous use for the reason of the Tester itself, it shall immediately stop using it and deposit it at once, leaving it for disposal by authorized agency.
- ◆ For risk of danger icon in manual “”, users must perform safety operations strictly in compliance with the manual content.

II. Introduction

Digital grounding resistance tester, also known as the **three-wire grounding resistance tester**, **grounding resistance meter**, etc., is a commonly used meter for measuring grounding resistance. It adopts a large LCD gray-white screen backlight

display and microprocessor technology to meet the requirements of two-wire and three-wire test resistance. **Suitable for telecommunications, electricity, meteorology, computer rooms, oil fields, power distribution lines, iron tower transmission lines, gas stations, factory grounding networks, lightning rods and so on. Instrument testing is precise, fast, simple, stable and reliable.**

The **digital grounding resistance tester** is controlled by the microprocessor and can automatically detect the connection status of each interface and the interference voltage and interference frequency of the ground network, and has the function of testing the auxiliary grounding resistance value. At the same time store 500 sets of data, **resistance measurement range: 0.01 Ω ~ 3000 Ω, grounding voltage range: 0.01 ~ 600.0V**

III. Measuring Range and Accuracy

Measuring Functions	Measuring Range	Accuracy	Resolution
Earth Ground Resistance	0.01Ω~30Ω	±1.5%rdg±5dgt (Auxiliary earth ground resistance 100Ω±5%, voltage to ground <10V)	0.01Ω
	30.1Ω~300Ω		0.1Ω
	301Ω~3000Ω		1Ω
Earth Ground Voltage	0.01~10.00V AC	±1.5%rdg±3dgt	0.01V
	10.1~100.0V		0.1V
	101~600V		1V

(Remark: 23°C±5°C, below 75%rh)

IV. Technical Specifications

Earthing Resistance Range	0.01 Ω ~ 3000 Ω Accuracy $\pm 1.5\%$ rdg ± 5 dgt
Ground resistance resolution	0.01 Ω
Grounding voltage range	0.01~600V AC Accuracy $\pm 1.5\%$ rdg ± 3 dgt
Ground voltage resolution	0.01V
Reference conditions	23 ° C \pm 5 ° C, 75%rh or less (Auxiliary earth resistance 100 Ω \pm 5%, voltage to ground <10V)
Function	Earth ground resistance measurement, voltage to ground measurement, low value resistance measurement
Power Supply	DC 6V 1.5V LR14 battery
Backlight	Controllable gray screen backlight, suitable for use in dim places
Measuring Mode	Precise 3-pole measurement, simple 2-pole measurement
Measuring Method	Earth ground resistance: rated current change-pole method, Test current >20mA (sine wave), 128Hz; Voltage to ground: average value rectification
Wire Resistance Verification	Avoid error caused by testing wire that is failed to be fully inserted into tester interface or by poor contact or by users' replacing or lengthening testing wires, making it more accurate for earth ground resistance measurement.
Display Mode	4-digital super-large LCD display, gray screen backlight
Measuring indicator	During measurement, LED flash indicator, LCD count down display
LCD Dimension	108mm \times 65mm
Dimension	L \times W \times H: 240mm \times 188mm \times 85mm
Testing Wires	Three wires: each for Red 15m, Yellow 10m, and Green 5m
Simple Testing Wire	2 wires: each for Red 1.5m and Green 1.5m
Auxiliary	2 PCS

earthing rod	
Measuring Rate	Voltage to ground: about 2 times/second; earth ground resistance: about 5 seconds/time
Measuring Times	Over 5000 times
Circuit Voltage	Measuring voltage to ground: measuring below AC 600V
Data Storage	500 sets, flash display " FULL " icon to indicate storage is full
Data Read	Data read function: " MR " icon display
Overflow Display	Exceeding measuring range overflow function: " OL " icon display
Alarm Function	When measuring value exceeds alarm setting value, there is beeper alarming
Battery Voltage	Battery power indicate in real time, the battery voltage is low and remind to charge in time
Power Consumption	Backlight: 25mA Max
	Standby: 25mA Max(Backlight shut off)
	Measurement: 70mA Max(Backlight shut off)
Weight	Tester: 1230g (including battery)
	Testing Wires: 610g (including simply testing wires)
	Auxiliary earthing rod: 360g(2 PCS)
	Meter bag: 1200g
Working Temperature & Humidity	-10℃~40℃; below 80%rh
Storage temperature & humidity	-20℃~60℃; below 70%rh
Overload Protection	Measuring earth resistance: between each interfaces of E-H 、 E-S , AC 280V/3 seconds
Insulation Resistance	Over 10MΩ(between circuit and enclosure it is 500V)
Withstanding Voltage	AC 3700V/rms (Between circuit and enclosure)
Electromagnetic Features	IEC61010-4-3, radio frequency electromagnetic field $\leq 1V/m$

Protection Type	IEC61010-1 、 IEC1010-2-31 、 IEC61557-1,5 、 IEC60529(IP54)、 Pollution grade 2、 CAT III 300V
------------------------	---

V. Tester Structure

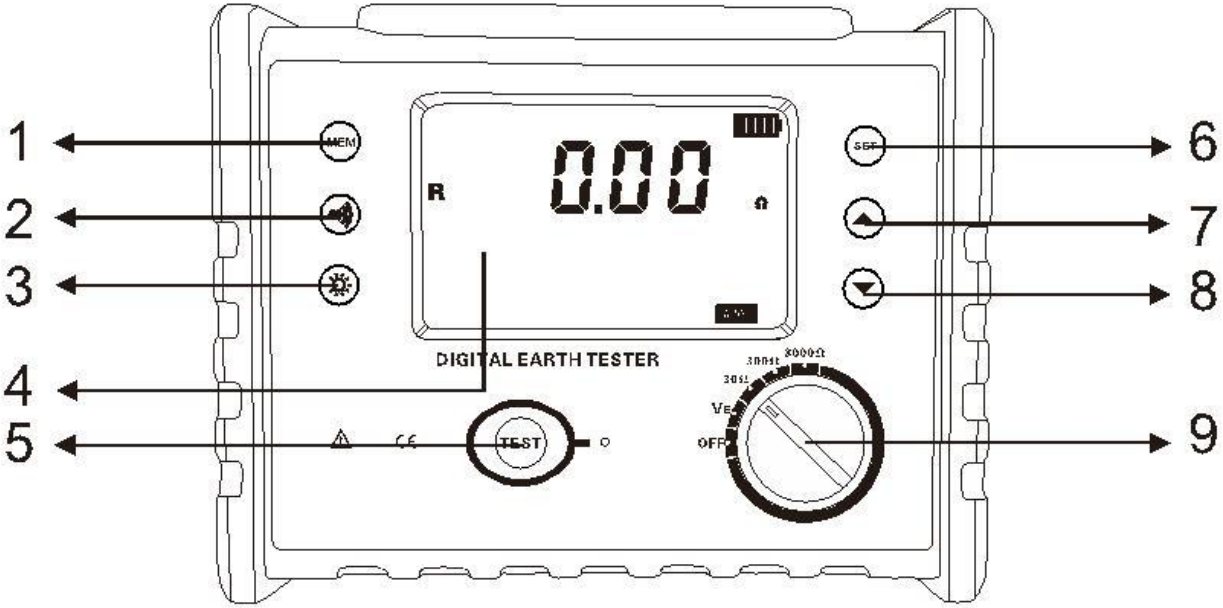

- 1. MEM Button
- 2. ALARM Button
- 3. BACKLIGHT Button
- 4. LCD
- 5. TEST Button
- 6. SET Button
- 7. UP Button
- 8. DOWN Button
- 9. Rotary Switch for Gear Selection

VI. Measuring Principle

1. Voltage to ground measurement adopts average value rectification method.
2. The grounding resistance value is measured using the rated current change method, that is, the rated current I (30mA Max, 128Hz) flowing between the

measuring object **E** (ground electrode) and **H** (current electrode); seeking potential difference **V** of **E** and **S** (voltage electrode) , then to determine the ground resistance **R_x**

$$R_x = V/I$$

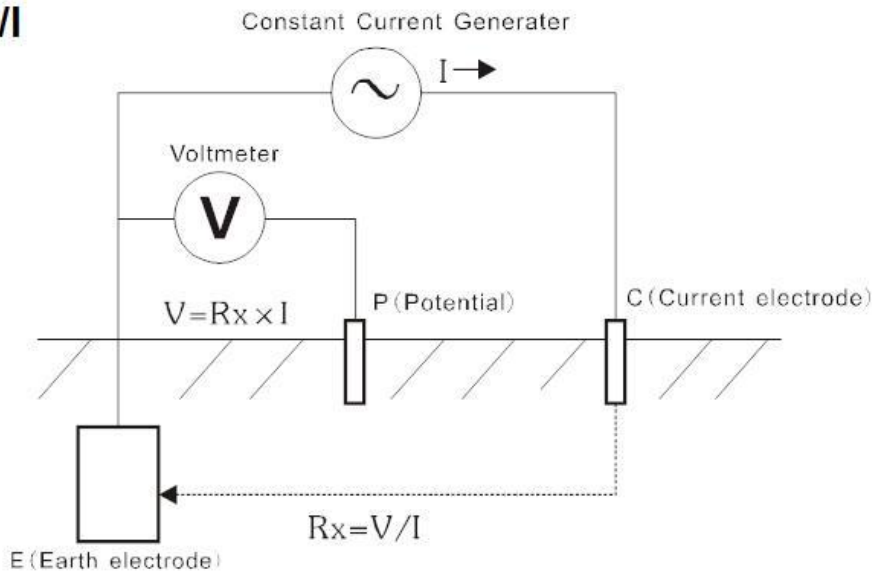

3. It's operating error(**B**) is an error obtained within the rated operating conditions, and calculated with the intrinsic error(**A**) and the error(**E_i**) due to variations.

$$B = \pm (|A| + 1.15 \times \sqrt{(E_1^2 + E_2^2 + E_3^2 + E_4^2 + E_5^2 + E_7^2 + E_8^2)})$$

A: Intrinsic error

E1: Variation due to position change

E2: Variation due to power supply voltage

E3: Variation due to temperature change

E4: Variation due to interference voltage change

E5: Variation due to contact electrode resistance

E7: Variation due to system frequency change

E8: Variation due to system voltage change

VII. Function Quick Check

POWER	Switch On/Off
MEM	Data browsing/value setting
☀ Backlight Button	Backlight control
TFRT Button	Start measuring
▼ Button	Delete data measurement selection
▲ Button	Wire resistance check/delete data measurement selection
Set Button	Set alarm value/delete data

MEM Button	Data Lock/Store/View
•)) Button	Alarm function start/alarm threshold setting
R and U	Measure gear selection

VIII. Operation Methods

1. Switch On/Off

Turn the function key to the corresponding test position and turn it on. Turn the function key to the OFF position to turn off the instrument, the meter will be automatically turned off, and after turning off, it will be turned to the OFF position and restart..

2. Battery Voltage Check

After switch on, if LCD displays low battery voltage icon “”, which indicates that battery voltage is low, and please replace the battery in time.

3. Ground voltage measurement

	Please make sure testing wire plug has been totally inserted into testers corresponding interface and it may cause measurement value error for incomplete insert or poor contact.
	The tester cannot be used for commercial power supply voltage measurement. For special situation that needs to measure, it can only use V, E interface to connect for measurement. It is not allowed to measure commercial power voltage in the case of short circuit of H, S interface. Otherwise, measuring voltage in the earthing circuit of cutout switch may cause cutout switch start.
	On measuring earthing voltage, please do not impose over 600V voltage on measurement connectors.
	When measuring ground voltage, do not touch exposed conductors to avoid electric shock.

After the auxiliary grounding rod and test line are connected, switch the function button U to the voltage level, the LCD displays the voltage to ground, and the measured voltage to ground cannot exceed 600V.

In general, for measuring earthing voltage, it is only to connect the testing wires corresponding to **V, E** interface. As shown:

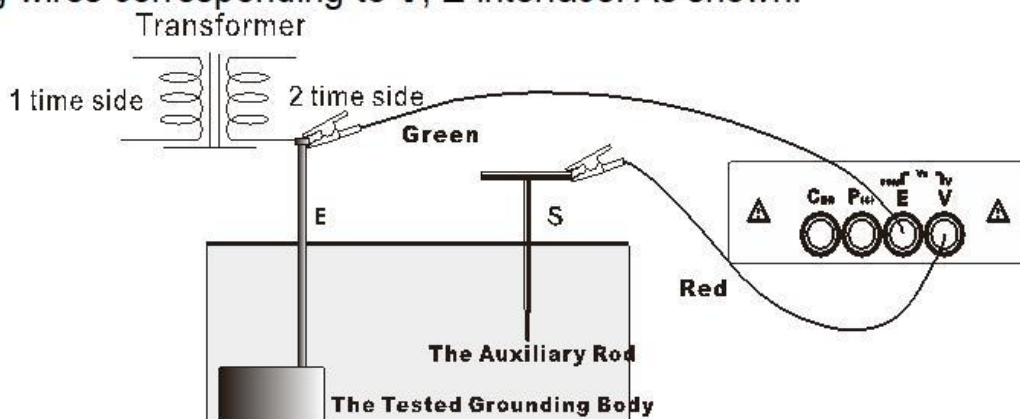

Note	Before measuring earth ground resistance, firstly please confirm voltage to ground must be lower than 10V. Otherwise, the measurement value may cause excessive error. At that time, firstly cut off power on measured earthing equipment and make resistance measurement after the earthing voltage is reduced.
-------------	--

4. Wire Resistance Verification

In order to improve precision and stability of field measurement of earth ground resistance, avoid error due to wire resistance change due to prolonged usage of testing wires; avoid error due to testing wire that is failed to be fully inserted into tester interface or by poor contact; avoid error due to users' replacing or lengthening testing wires and etc., wire resistance verification is specially designed, which is more accurate on low value resistance measurement.

As shown in the figure below, press the function button R button to switch to the corresponding ground resistance measurement position, press ▲ button to start verification. During verification, During the calibration, the LED indicator flashes. The LCD counts down. After the calibration is completed, the LCD displays the line resistance and stores the value. The checked line resistance value is automatically deducted from this start-up ground resistance measurement.

Shutdown does not save the calibration line resistance. The next time you turn on the power, you need to verify again..

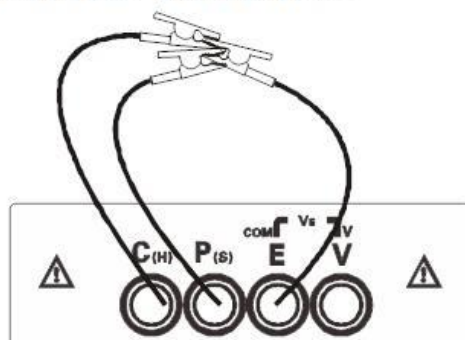

5. Grounding Resistance Precision Measurement

	Please make sure testing wire plug has been totally inserted into testers corresponding interface and it may cause measurement value error for incomplete insert or poor contact.
	As to low value earth ground resistance measurement, it will be more accurate after wire resistance verification.
	On measuring earthing voltage, between E and C interface, it will occur the maximum voltage about 50V! Please do not impose voltage on measurement interface. Please pay attention to avoiding electric shock accident.

	On measuring earth ground resistance, testing wires cannot be mixed around, which shall be measured separately.
	Try to choose the spot with more water to deeply bury auxiliary earthing rods H and S, in order to reduce auxiliary earth ground resistance and thus reduce indication error.

Precision measurement grounding resistance adopts three-wire connection, auxiliary grounding rod and test line are all connected, switch function to measure resistance R mode, press key to press “TEST” key to start measurement, LED indicator flashes during measurement, LCD countdown display, after measurement is completed The indicator is off and the LCD shows the measured value. Starting from the measured object, insert the auxiliary grounding rod into the earth every 5 to 10 meters, connect the grounding test lines (red, yellow, and green) from the H, S, and E ports of the meter to the auxiliary current electrode H, auxiliary voltage electrode S, and ground electrode E under test. As shown:

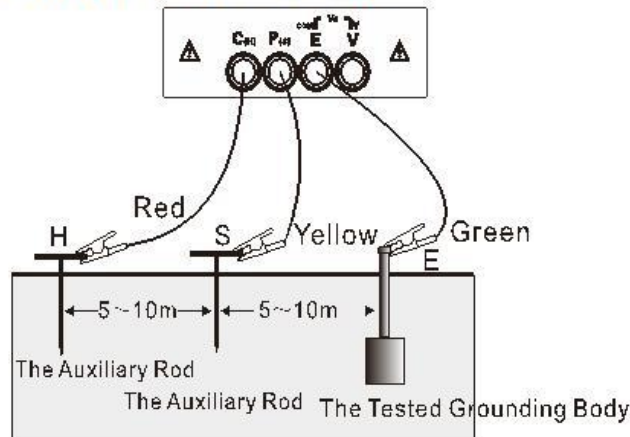

6. Simple Method for Measuring Ground Resistance

	When select commercial use power supply system earth as auxiliary earth electrode, it must use detector to confirm that it is the earth ground electrode for commercial use power supply system.
	It is forbidden to use this tester to confirm earth electrode of commercial use power supply system

This method is a simple method for measurement that does not use auxiliary earthing rod, taking the earth electrode with the minimal existing earth ground resistance value as auxiliary earth electrode, and connecting by two simple testing wires (in which H, S interfaces are in short circuit). It can make use of metal pipes, fire hydrants and other metal buried objects, common earthing of commercial electric power system or lightning protection earth ground electrode and others to replace auxiliary earthing rods H, S, and

pay attention to remove oxide layer on the connection point of the selected metal auxiliary earthing object when making measurement.

Earth ground resistance simple testing wire connection is as following figure, and refer to precision measurement for other operations.

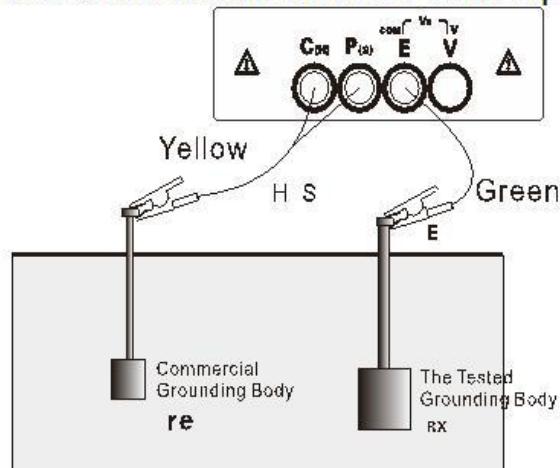

Simple method for measurement of earth ground resistance, its reading on Tester is the total value of earth ground resistance value of measured earthing object and that of commercial earthing object, namely:

$$RE = RX + re$$

In which: **RE** is the Tester reading value;

RX is the earth ground resistance value of measured earthing object;

re is the earth ground resistance value of common earthing object like commercial use power system.

Then, the earth ground resistance value of measured earthing object is:

$$RX = RE - re$$

Adopting simple method for measurement of earth ground resistance shall try to select the earthing object with low value as the auxiliary earth ground electrode, then the tester reading value can be more approaching to true value. Please take precedence in selecting metal water pipes, fire hydrants as auxiliary earth electrode when measuring.

Note	Simple method for measurement of earth ground resistance also needs to confirm that voltage value to ground must be lower than 10V. If the voltage value is over 10V, the measurement value of earth ground resistance may cause error and at that time, it shall firstly cut off power on measured earthing equipment and make resistance measurement after the earthing voltage is decreased.
-------------	---

7. Backlight Control

After startup, press “☀” button to turn on or off backlight. The backlight function is suitable to dark spot. It will default backlight turn-off for each startup.

8. Alarm Settings

After power on, short press “●))” to turn on and off the alarm function. Short press “SET” key to set the resistance alarm value, press “●))” key to move the cursor, press “▲” or “▼” key to change the current size, and then press “SET” key to save and exit. When the measured value is greater than the alarm critical setting value and the alarm function is turned on, the meter displays the “●))” symbol and issues a “beep-beep-beep--” alarm sound.

9. Data Lock/Storage

Startup or after measurement, press “MEM” button to lock current displayed data, showing “MEM” icon and automatically store with serial numbers. If storage is full, the Tester will display “FULL” icon. to remove lock. As shown in figure below: the lock measurement data is 1032Ω, press “MEM” button save as the 3th group of data .



10. Data Review/Deletion

Startup or after measurement, press “MEM” button for a longer time (over 3 seconds) to enter data reading, the interface corresponding to the stored data interface and the stored data group number flash alternately. Press ▲ or ▼ button to select reading data group number by step value 1, press ▲ or ▼ button constantly to select reading data group number by step value 5, and then press “MEM” button to exit from reading.

In the figure below, the number 3 is the current group number, and 6 is the total group number, LCD will display “NULL” , see the above figure.



Under data reading status, press SET button to enter data deletion, press ▲ or ▼ to select “NO” or “YES”, selecting “NO” and then pressing SET button for not deleting and return data reading status, selecting “YES” and then pressing SET button for deleting stored data and it will show as above right

figure after deletion.



IX. Battery Replacement

The instrument is powered by 6 1.5V LR14 batteries. When the battery power is reduced, the power indicator bar is reduced. When the voltage drops to 5V, the battery symbol  is displayed.

X. Accessories

Tester	1 PC
Tester Bag	1 PC
Auxiliary Earthing Rod	2 PCS
Testing Wire	3 PCS
Simple testing wire	2 PCS
1.5V battery	6 PCS
Manual , Qualification Certificate	1 SET



GuangZhou ZhengNeng Electronics Technology Co.LTD

Address: 4th Floor, No. 771, Guangcong Eighth Road, Changyaoling
Village, Zhongluotan Town, Baiyun District, Guangzhou, China

Tel: 86-20-36544172

E-mail: hsh@znele.com

Post: 510540

WebSite: www.fuzrr.com