



CSP Holding Group

China Solar Power & China Super Power



CSP Solar™

Easton solar



CONTENTS

01

PROFILE

- Company Introduction
- CSP Family
- Main Business Ranges

PRODUCTS

02

03

PRODUCTION LINE

PROJECT

04

05

NETWORKS



Our Mission

CSP Holding Group has been dedicated to creating the most cost - effective automation equipment and renewable products for more than 30 years in China. Our product range includes solar thermal products,heatpump, solar power systems, water heater automatic production lines, LPG cylinder automatic production lines, laser welding and cutting machines, rolling forming lines, CNC punching and bending machines, and hydraulic cylinders for dumpers. Right now, we have global service centers and local offices to offer fast and professional services for our customers locally, such as in Europe, India, Latin America and so on.

Green Life,Our Care!

CSP Family





CSP Family

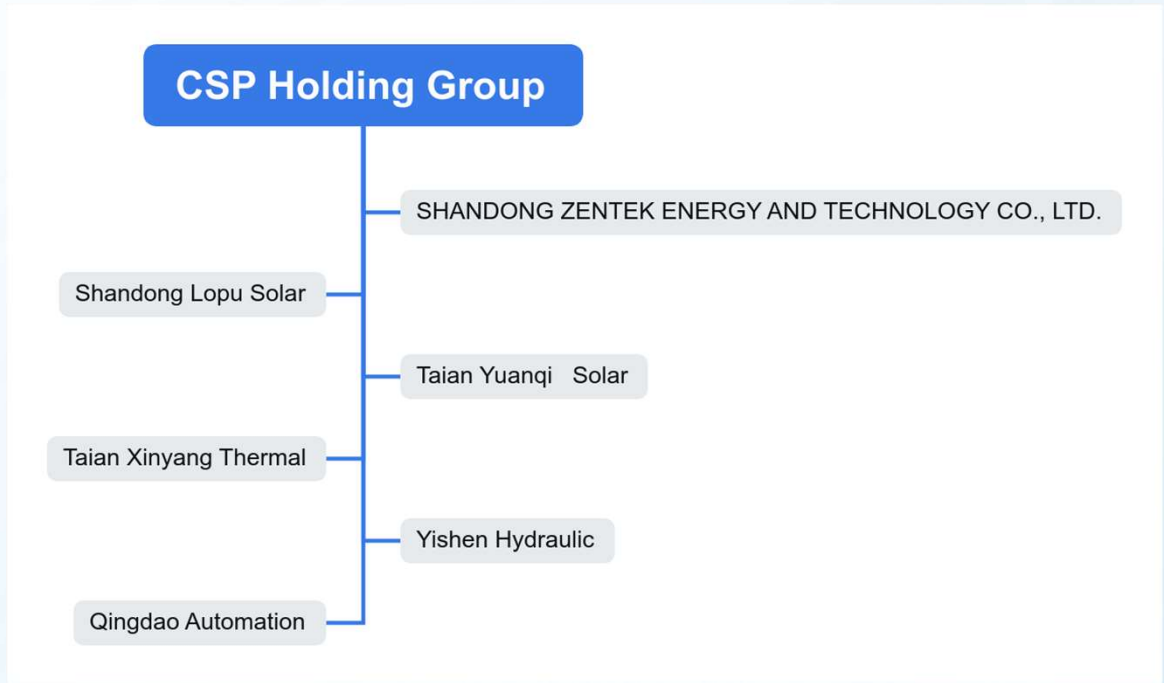

Our Factories



Solar Vacuum Tube Plant



Solar Water Heaters Plant



Machine Manufacturing Plant

01

Renewable
Energy:
Solar Water
Heater, Solar
Collector, Solar
Vacuum Tube;
Solar Panel; Heat
Pump

02

Water Heater
Tank
Production Line
& Equipments
(Solar Water
Heater, Electric
Water Heater,
Gas Storage,
Heater, Glass
Line Tank, Heat
Pump
Tank); Roll
forming line

**CSP Holding Group
Mission**

04

Hydraulic
Cylinder
(Dumper
Truck & Loader)

03

Solar Power Plant
Investment ;
Transformer ;
Distribution

CONTENTS

01

PROFILE

- Company Introduction
- CSP Family
- Main Business Ranges

PRODUCTS

02

03

PRODUCTION LINE

PROJECT

04

05

NETWORKS

Solar Water Heating Solution



Non-pressurized SWH



Pressurized Heat Pipe SWH



Pressurized Split Heat Pipe SWH



Flat Plate SWH



CPC Vacuum Tube Collector

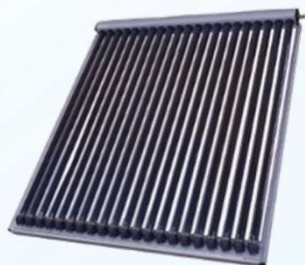

U-pipe Vacuum Tube Collector



Heat Pipe Vacuum Tube Collector



Non-pressurized LPC Collector



Flat Plate Collector

Our Capacity:

Solar Collector: 100000 units/year

Solar Water Heater: 200000 units/year

Solar Water Heater Spare Parts



Full Range of Solar Vacuum Tubes



**Blue
Solar Vacuum Tube**



**Purple
Solar Vacuum Tube**



**Black
Solar Vacuum Tube**



**Heat Pipe
Solar Vacuum Tube**

Heat Pipe: 2million pcs/year

Solar Vacuum Tube: 15million pcs /year



Ripple Solar Vacuum Tube



**Double-ended Open Solar
Vacuum Tube**



**Large Diameter Solar
Vacuum Tube**



**All Glass Heat Pipe Solar
Vacuum Tube**



**Glass Metal Heat Pipe
Collector Tube**

New Launch

Metal-Glass Heat Pipe Solar Collector



Tankless Solar Collector



Solar Cooker & Big Size Solar Vacuum Tube

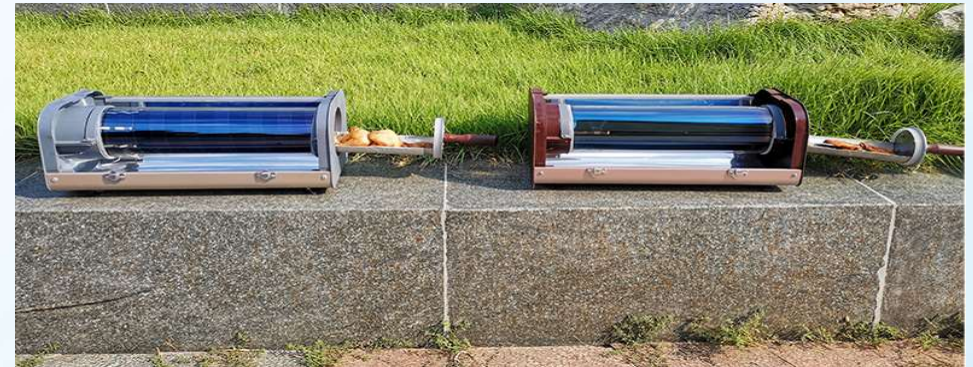

Air Conditioner + Free Hot Water System



Heat Pump OEM&ODM



Buffer Tank/Solar Jacket Tank/Heat Pump Enamel Tank OEM (100/200/300/500L)

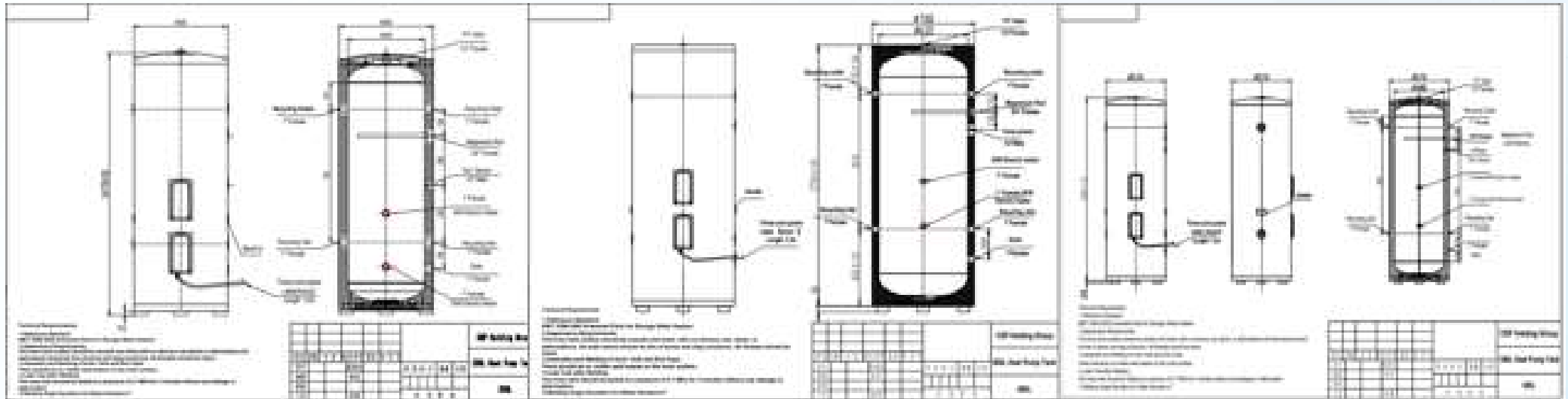

200L

300L

500L



Our Capacity:
300Tanks /Shift based on 500L tank



Solar Power Project(EPC& BOT)



Residencial

1-50KW



Commercial

100-1000KW



Ground Project

1-100MW



Electric Water Heater OEM&ODM



CONTENTS

01

PROFILE

- Company Introduction
- CSP Family
- Main Business Ranges

02

PRODUCTS

03

PRODUCTION LINE

04

PROJECT

05

NETWORKS

Solar Water Heater Production Line Turnkey Solution

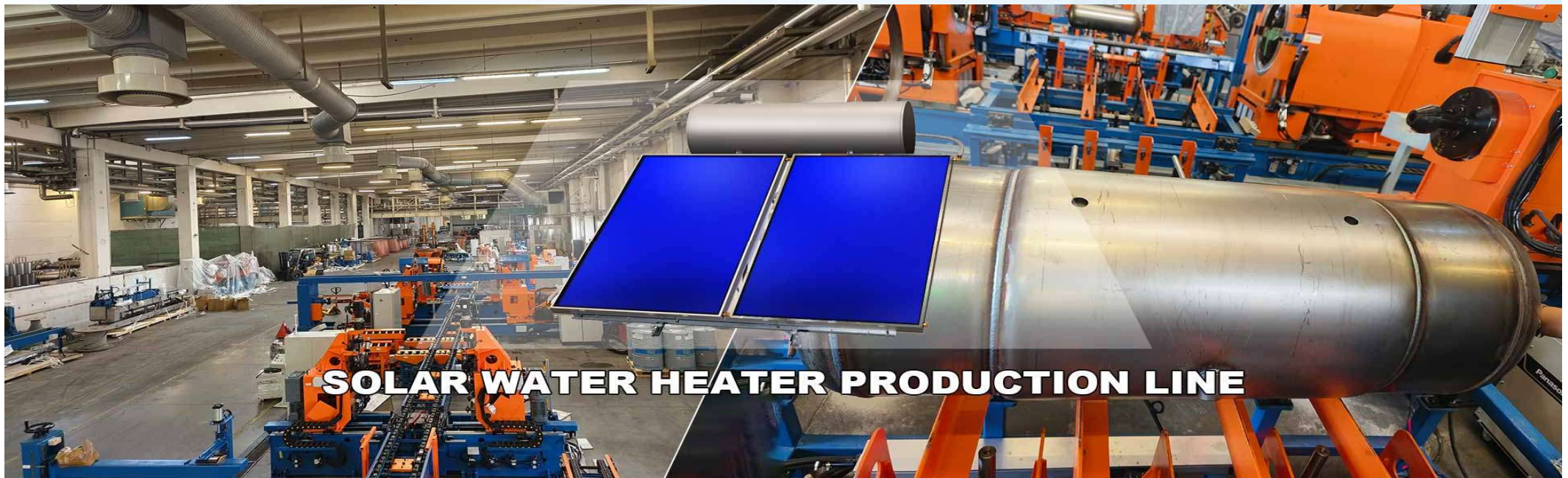

Electric Water Heater Production Line Turnkey Solution



Roll Forming Production Line Solution



Polyurethane Foaming Machines



U-shaped Pillow



Memory Pillow



Mattress



Office Chair



Car Seat



Disinfection Cabinet



Wine Cabinet



Freezer



Electric Water Heater



Solar Water Heater



Insulation Board



Insulation Box



Cold Storage



Insulated Water Tank



Refrigerated Truck



Steering Wheel



Roman Column



Imitation Wood Door



PU Culture Stone



PE Insulation Pipe

LPG Cylinder & Steel Drum Turnkey Solution

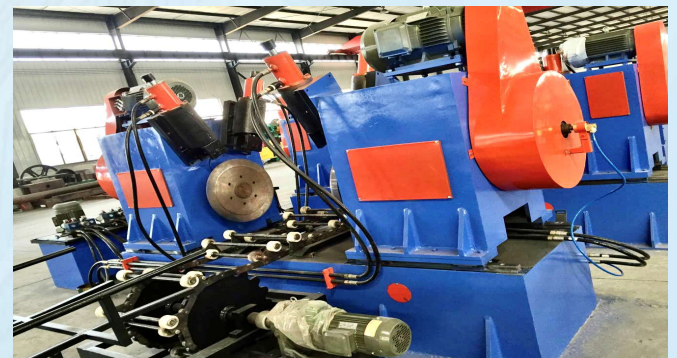
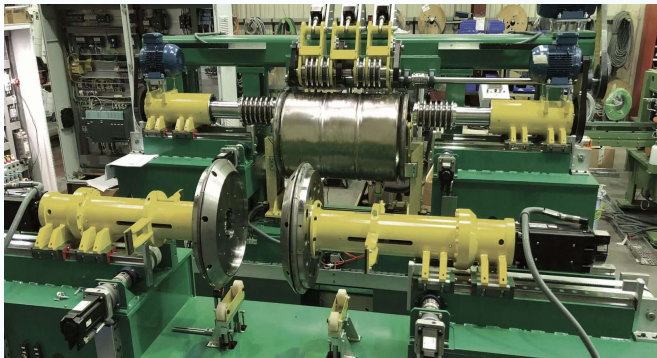

CONTENTS

01

PROFILE

- Company Introduction
- CSP Family
- Main Business Ranges

PRODUCTS

02

03

PRODUCTION LINE

PROJECT

04

05

NETWORKS

Overseas Solar Thermal Projects



Overseas Solar Water Heater Production Line



Overseas Electric Water Heater Production Line



Overseas Electric Water Heater Production Line



Overseas Flat Solar Collector Production Line

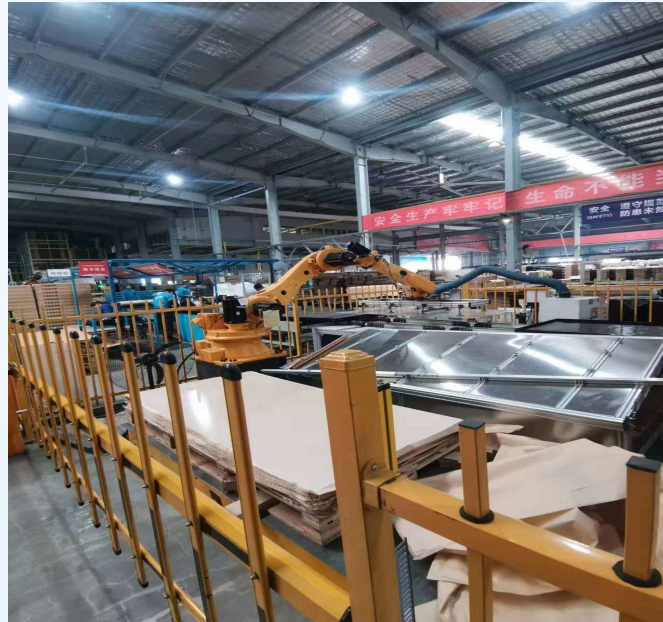
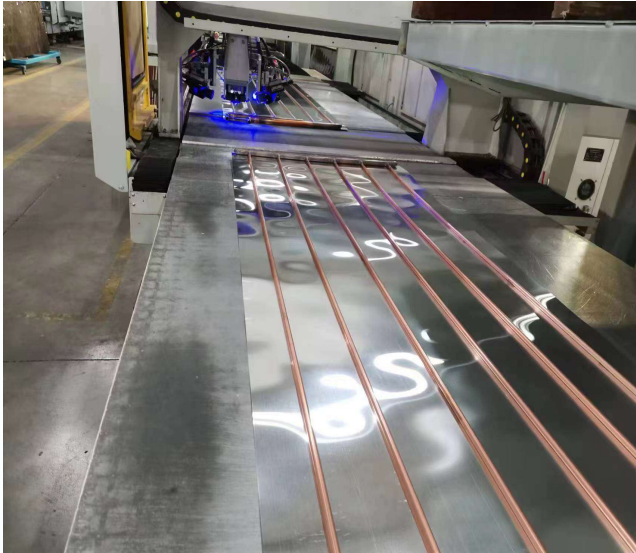

Overseas LPG Cylinder & Steel Drum Production Line



CONTENTS

01

PROFILE

- Company Introduction
- CSP Family
- Main Business Ranges

PRODUCTS

02

03

PRODUCTION LINE

PROJECT

04

05

NETWORKS

Our Services



Technology Design

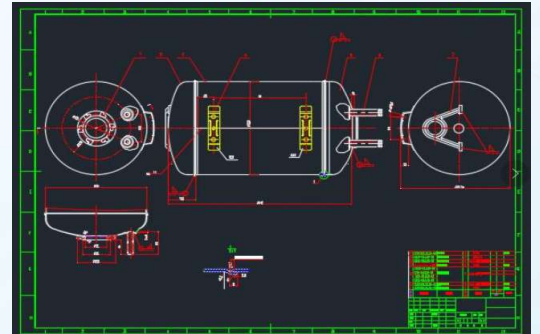

Machinery Supply

Factory Operation Backup

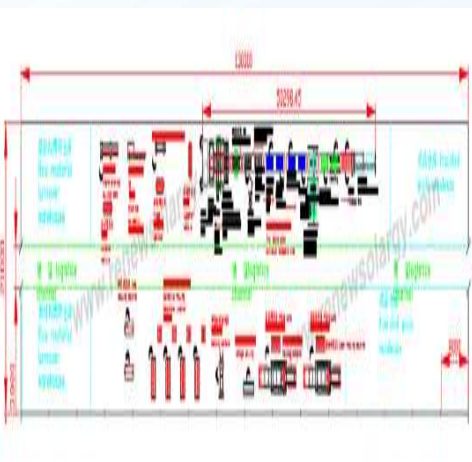

Installation & Training



Worldwide Customers



Contacts

WeChat: blank971

Mobile/WhatsApp:+8618954549988

david@renewsolargy.com

Tel:+86 53161366718

Fax:+86 531 61366718

info@renewsolargy.com

www.renewsolargy.com

Global Marketing Head Office:

Add: No.12308 East Jingshi
Road, Jinan City, Shandong,
P.R.China



RENEW SOLARGY

Head Quarter:

No. 7, Lushan South Road, High tech
Zone, Liaocheng City,
Shandong Province, P.R.China





Thank You for Your Attention!

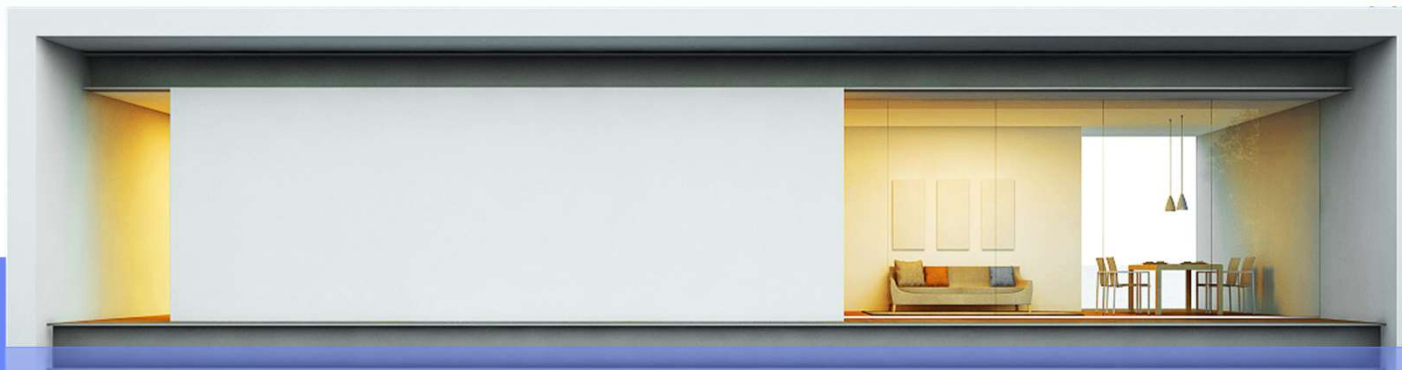

Our Renewable Products, Your Green Life Resource!