



 innovation for a smart future

ONE STOP SHOP FOR DIGITAL IMPLANTOLOGY



 Hetailai Digisolution Dental

+8619128063813

lisalee@szhetailai.com

<https://m6cadcam-dental.com/>

Building A9, Gunangsha Road, Fuyong street, Bao' an district, Shenzhen, Guangdong Province, China. Postal . code: 518103



M6 Brand - Introduction

M6 enterprise was established in 2007. As a professional medical equipment manufacturer ,M6 is driven by the mission to build a top quality implant company.By stating the long-lasting faith for the health of all human being ,sustainable growth of a green world,we are committed to research & develop with great effort.With abundance of time, capital ,human-resources invested into M6 implant project and supportive production,M6 obtained CRISC and FDA501(K) .As an international medical company with global vision,an enterprise in oral healthy professional Pled M6 has been exported implant to Mexico , United States ,countries in Europe and Asia. Among those more than 20 countries , M6 builds a trusted image by providing high quality implant , dental material, and general medical product.It is , and it will be, the customers-oriented point of core value, to motivate M6 keening on researching developing, innovating best quality product and services.



INNOVATION for A SMART FUTURE

ONE STOP SHOP FOR DIGITAL IMPLANTOLOGY

Choose M6

With the perfect implant restoration as the guide, focus on innovative technology, through the clinical technician digital application of knowledge based on equipment/ implant accessories/ professional training/difficult cases to solve/surgical solutions, from the first phase of cavity preparation implants to the upper permanent restoration to provide you with digital oral implants one-stop service.

Core Values

With the core values of innovation, customer achievement, integrity and responsibility, Hetailai people promote new technologies together with industry colleagues and step into the digital future.

INNOVATION FOR A SMART FUTURE

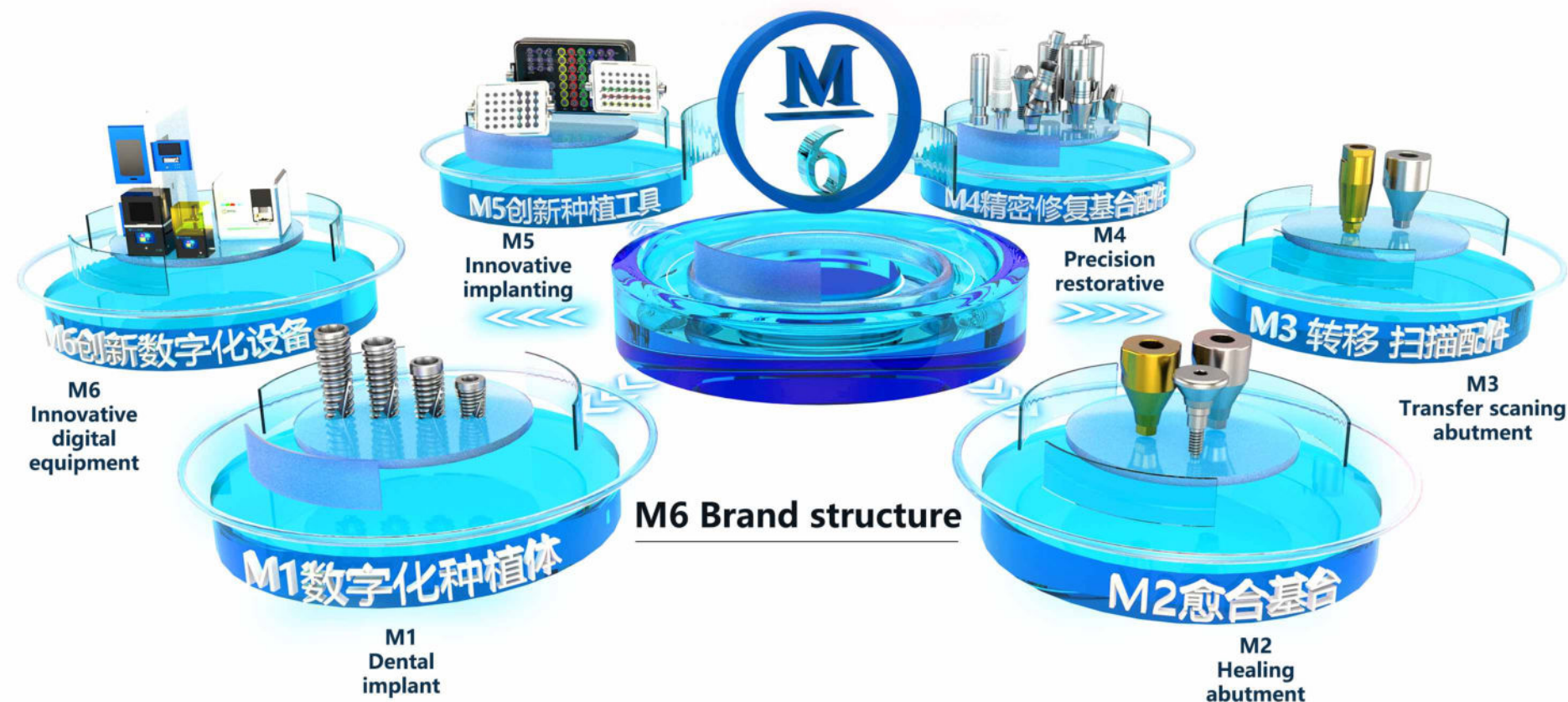

Hetailai Group - Introduction

Founded in 2012 in Shenzhen, the capital of innovation, Hetailai is an innovative dental technology company dedicated to helping dentists solve the complex challenges of restorative dentistry while improving the quality of life of patients around the world. After 13 years of development, the company has formed a digital dentistry group that is now in its infancy. With the core values of innovation, customer satisfaction, integrity and responsibility, we are committed to promoting new technologies with our colleagues in the industry and moving into the digital future together.

Hetailai Dental Digital Industrial Park

covers an area of 7000+ square meters



Comprehensive service



He Tai Lai brand



Research and development of planting accessories



Technical support | 3 D printing | operation program training



Difficult repair design processing and milling services



Milling machine research and development production

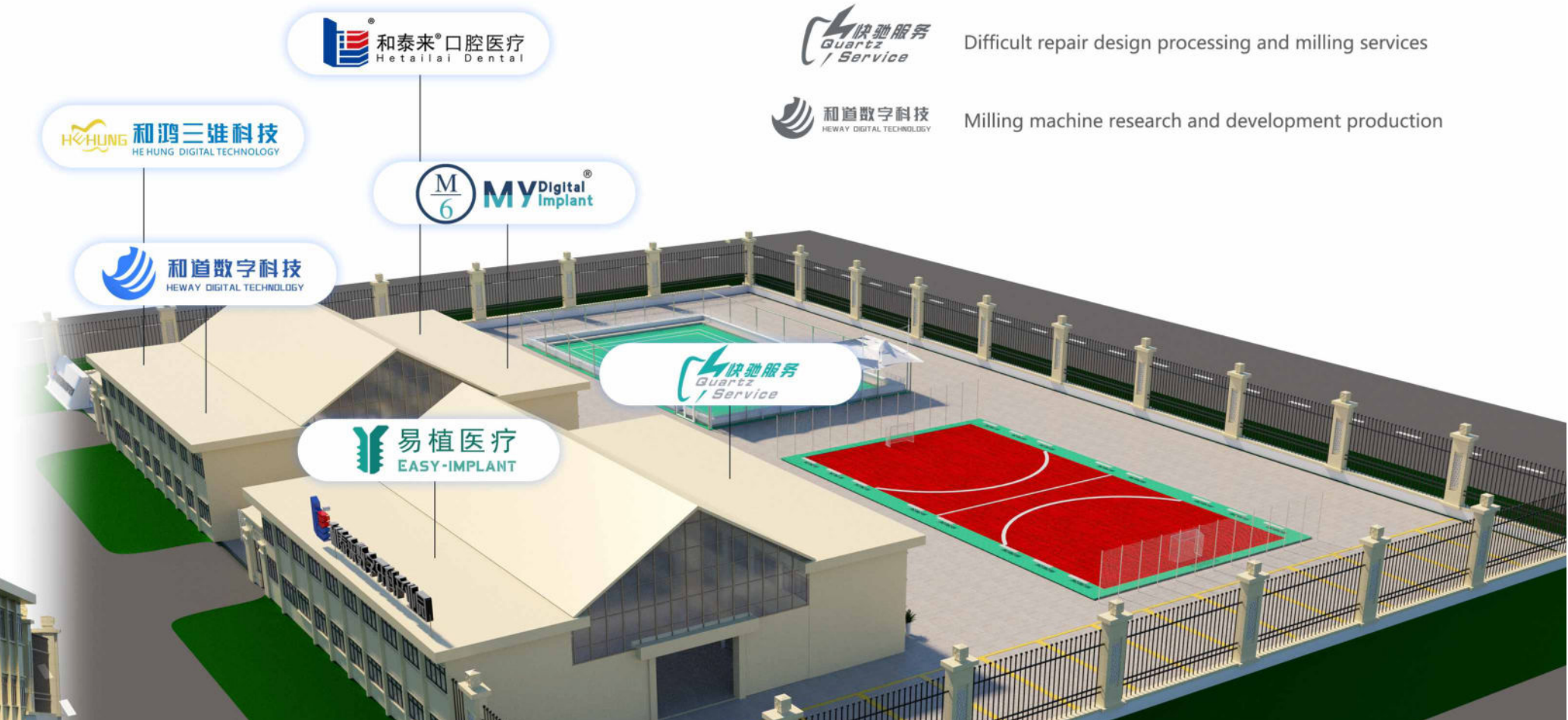

The production capacity is 467,000 pieces per month

50 imported automatic production lines in **3** workshops in Shenzhen, Dongguan and South Korea

Quality assurance

Product quality inspection process must pass intelligent full inspection of equipment - semi-automatic inspection equipment - manual inspection, average 20 procedures and quality inspection process, to ensure product accuracy and quality.



2012

Founded in 2012, Hetailai dental has been focusing on the innovative application of digital dental implants for 11 years. We provide one-stop service to the dental labs by "total solution". Our original "3S Digital Implant Service" has supported the start and development of more than 1000 implant restoration businesses.

2015

In 2015, we set up a 24-hour digital service center to provide design and processing services for dental labs, and our 24-hour commitment to high quality and fast delivery has been recognized by our European and American customers.

2016

In 2016, with the participation of several implantologists and restorative dentists, we set up a "Research and Development Center" and a presentation center for digital dentistry. The collaboration of all parties provides high-quality technical support for the growing number of implant

2017

In 2017, our high quality products and complete solutions won the favor of foreign partners to expand our products to the United States, Australia, Russia, etc. on an OEM service.

2018

In 2018, we launched the research and development of implant restoration category, focusing on the research and development of AIO system in the field of implant restoration segment to fully carry out the licensing of AIO system. In the same year, we invested in the research and development of 3D printers and materials, and launched a variety of complex implant solutions.

2019

In 2019, we obtained several CFDA licenses for implant accessories. Completed M6 brand system implants and peripheral accessories, and DEN-TOP brand successfully opened overseas market.

2020

In 2020, we built a digital industrial park to fully realize the integrated industry chain from equipment production to implant restoration. And the establishment of the implant milling machine division will not forget the original intention to focus on the innovative application of digital dental implants, and constantly overcome complex problems to make implantation more simple.

2021

In 2021, in order to solve technical problems, we do training 200+ times, oriented to perfect implant restoration, dedicated to the complex challenges of dental restoration, the professional technical team composed of professors from Taiwan provides free training public courses on digital technical knowledge, equipment operation, software design, etc. The first 10 cooperative tour exhibitions with Shining 3D were held in Hangzhou, Quanzhou, Fuzhou, Changsha, Shijiazhuang, Taiyuan, Chengdu, Chongqing, Luoyang and Xi'an. The tour courses are digital-oriented combined with clinical applications, case studies, analysis of difficult cases, and seminars on new technology solutions for colleagues to exchange and share, and make progress together to promote the progressive development of the industry.

2022

In 2022, we started a number of CFDA Class III certifications, focusing on research and development of innovative implant restorations, investing more manpower and equipment for research and development, and setting up several laboratories and corresponding instruments for new product testing. The capital investment more than 10 million, 12 imported fully automatic production equipment, now Shenzhen / Korea / Dongguan a total of 40 fully automatic production line, the monthly production capacity of 370,000 pieces.

2023

In 2023, we Hetailai M6 were the first company in China to get the Class III medical devices registration certificate for Scannable Healing Abutment, Customized Abutment and Screws, and Cutting Abutment Blank and Screws. At the same time, we obtained the certificate of "High-tech Enterprise". we add 5 imported fully automatic production equipments, and own 50 fully automatic production lines for now, the monthly production capacity reaches 467,000 pcs.

2024

In 2024, Hetailai will develop a new multi-unit scanning rod toolbox to open a new era of edentulous oral scanning, bravely climb a new peak of dental technology, and solve the pain points of edentulous single-form oral scanning distortion in the industry. At the same time, it ushered in the good news that three types of registration certificates [personalized abutments and screws] were approved. In 2024, Hetailai Dental Digital Industrial Park will expand its use area to 7,000+ square meters, and in terms of hardware facilities, it will invest heavily in imported equipment such as vacuum titanium nitride gold plating machine, five-axis cutting machine, anodizing equipment, automatic full inspection equipment, automatic packaging and other advanced equipment and instruments, laying a solid foundation for innovative R&D and production, and moving forward at full speed towards the future of dental digitalization.

Thirteen years
13
history of Hetailai dental

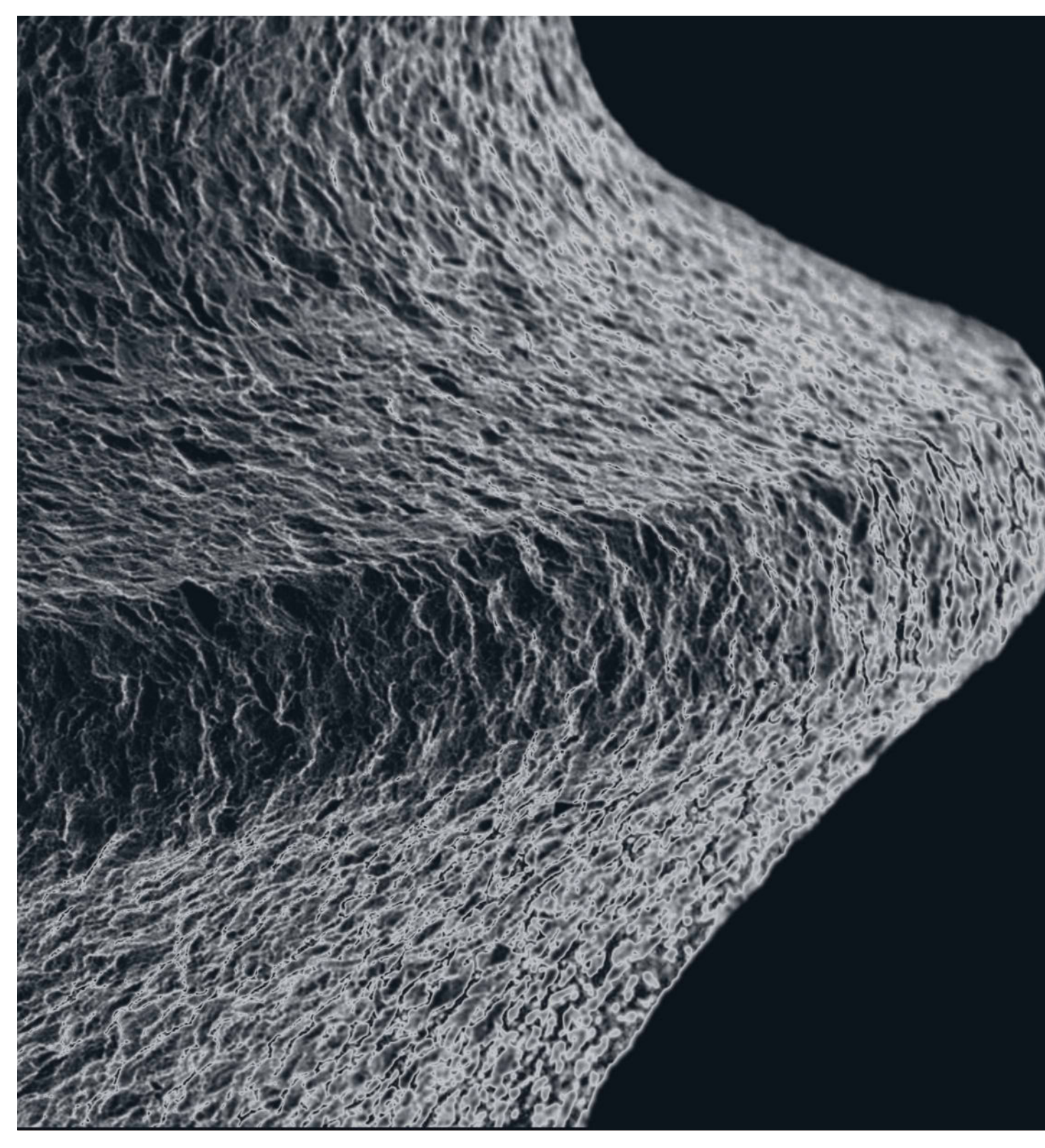

M1 Dental implant

P3 Dental implant

M2Healing abutment

P7 All In One Digital Solution

M3transfer scanning abutment

P11 Titanium intra oral scanbody

P13 All In One Digital Solution

P15 Scannable grinding abutment

P17 multi scanbody for edentulous

M4Precision restorative parts

P23 Titanium premills

P25 Scannable grinding abutment

P27 M6 - Multiunit

P29 Multi Conical Universal Screw

P31 Easy-Implant overdenture abutment

P33 Stock abutment

P35 Ti-base

P37 Abutment Screw

P39 3D Analog

P41 M6 Analog

M5Innovative planting tools

P45 A: Half-cover surgery guide kit

P49 B: Implant placement tool kit

P51 C: Simple Half-cover surgery guide kit

P53 Carrier kit for 3D digital analog

P55 Carrier kit for 3D digital analog Compatibility

P57 Lab Art 9 pcs Screw Driver

P59 Clinic screwdriver

P61 Hand-held grinder kit

P63 Compatibility list for hand-held grinder

P65 M6-Hand-held grinder

M6Innovative digital equipment

P69 Mill T4 Pro

P71 MillT4 Pro X

P73 Mill T5 Pro



Dental implant



M/6 DIGITAL IMPLANT

Simplicity
One implant design / various connections



Initial Stability: Progressive thread with compression properties and drilling blade on the apex enable to adjust the implant position during placement .

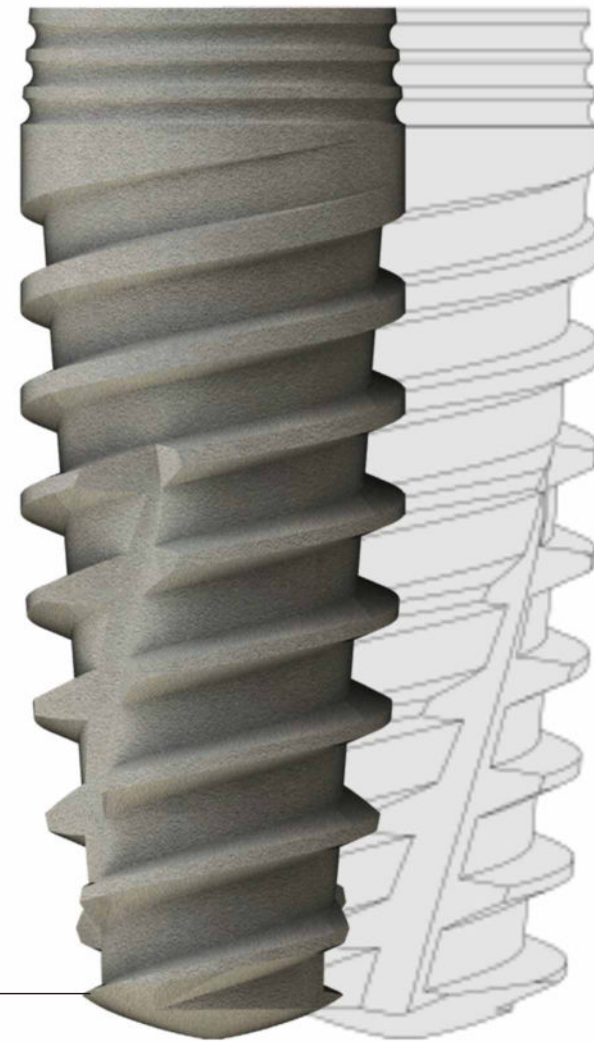

implant characteristics :

Build-in Platform switching

Micro Rings: Tapered coronal design and micro rings designed to reduce bone stress and minimize bone resorption to optimize bone and soft tissue volume.

Dual Threads : tapered implant body & core with dual threads and optimal pitch of 1.0 mm for faster implant insertions with better stability.

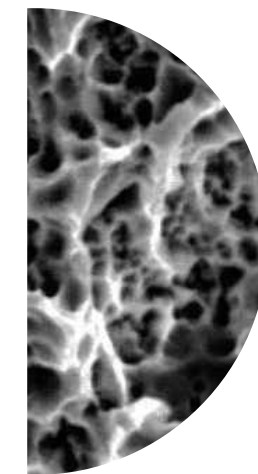
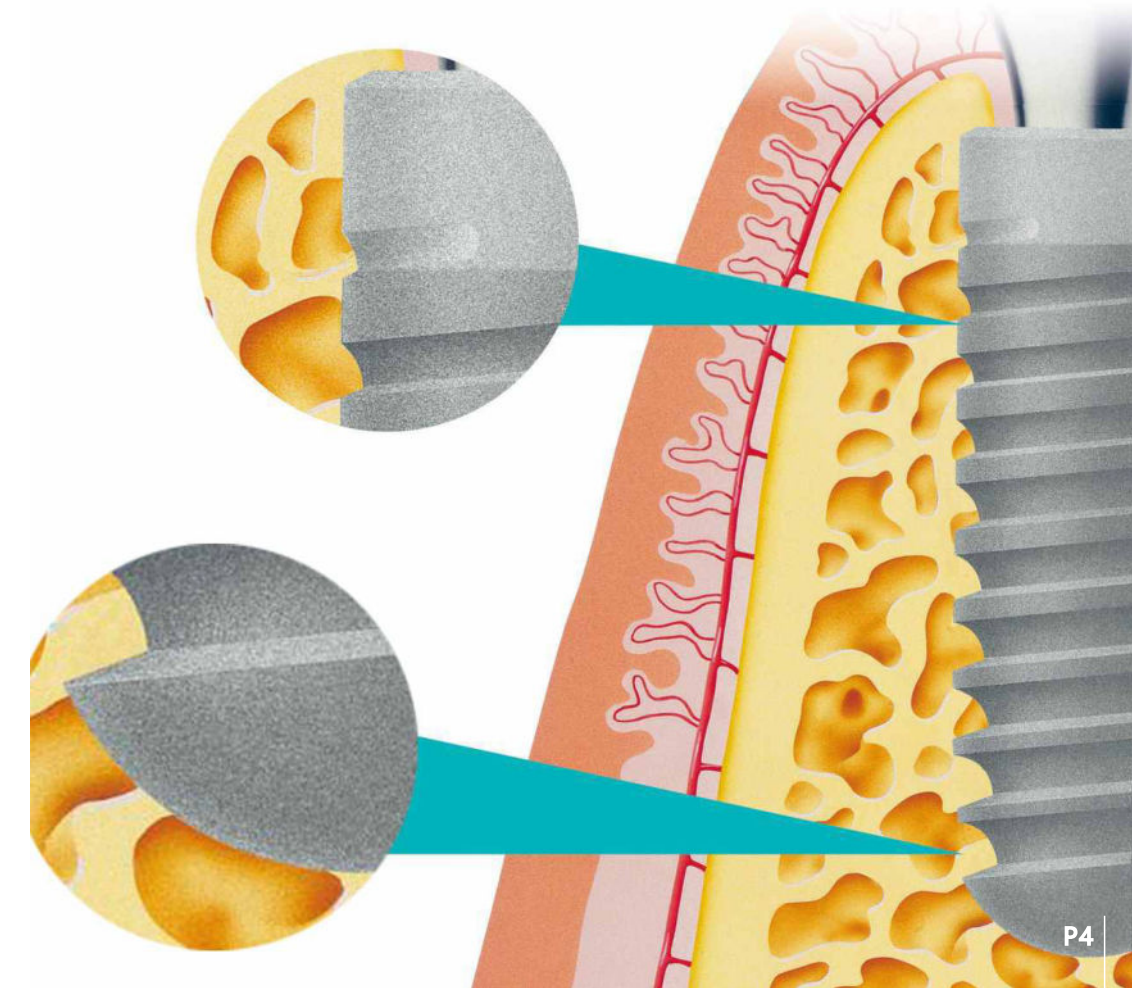



Healing abutment



AIO System All In One Digital Solution

✓ Multi functions in one abutment ✓ No restricted mouth opening anymore

The AIO System is the new all-in-one digital solution for implants. It allows the technician to intervene earlier in the doctor's implant case and the doctor & technician to work more closely together. The healing abutment, transfer, the impression coping and the intra-oral scan body all combine to save money on implant accessories. Whether the dentist uses intraoral scanning or conventional impression taking, it is easy to use and makes implantology more precise. The simple treatment process saves time and effort and reduces the patient's stress.



combine healing and data transfer functions in one abutment

- No scanbody
- No transfer
- No healing abutment
- No analog

New Full Kit

Easy to collect Precision manufacturing with multiple holes High temperature and autoclave resistant Meet conventional healing and transfer

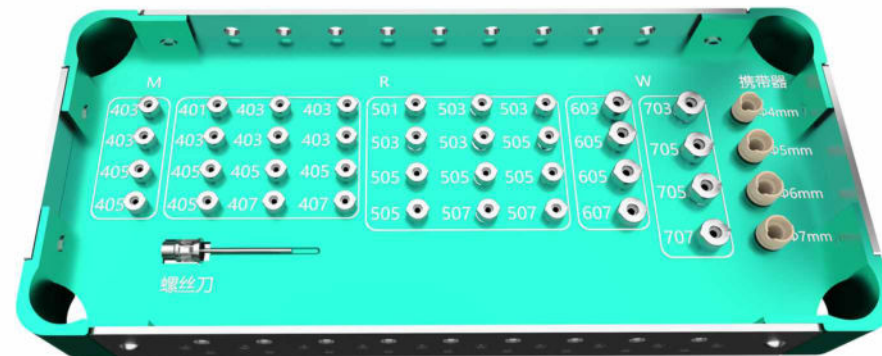

Meet conventional healing and transfer needs

Positioning points



Note: Positioning points correspond to gingival high



Transfer scanning abutment



Titanium intra oral scanbody

- ✓Spray free✓titanium one-piece material
- ✓TiN coated✓platform-screwed

After thousands of tests with intra oral scanner, 90% of domestic and foreign brands can easily obtain accurate data, a section of grade IV titanium material makes the service life longer. Vacuum titanium nitride coating, easy to get data without powder spraying, high melting point, high strength, high hardness, acid and alkali erosion resistance, wear resistance, high temperature chemical stability. The addition of platform changes the traditional taper fixing to a platform fixing, avoiding the positioning errors caused by the different torque sizes of the traditional taper positioning and making the positioning of the planting depth more accurate.

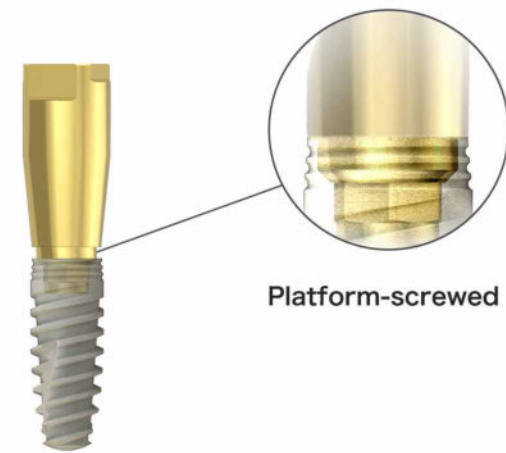

Platform-screwed

Library is available for 50+ brands, 70+systems,130+sizes



Platform-screwed

The addition of platform changes the traditional taper fixing to a platform fixing, avoiding the positioning errors caused by the different torque sizes of the traditional taper positioning and making the positioning of the planting depth more accurate.

Long-time durability

a section of grade V titanium material makes the service life longer,Vacuum titanium nitride coating,easy to get data without powder spraying,high melting point, high strength

After thousands of tests with intra oral scanner
90% of domestic and foreign brands can easily obtain accurate data

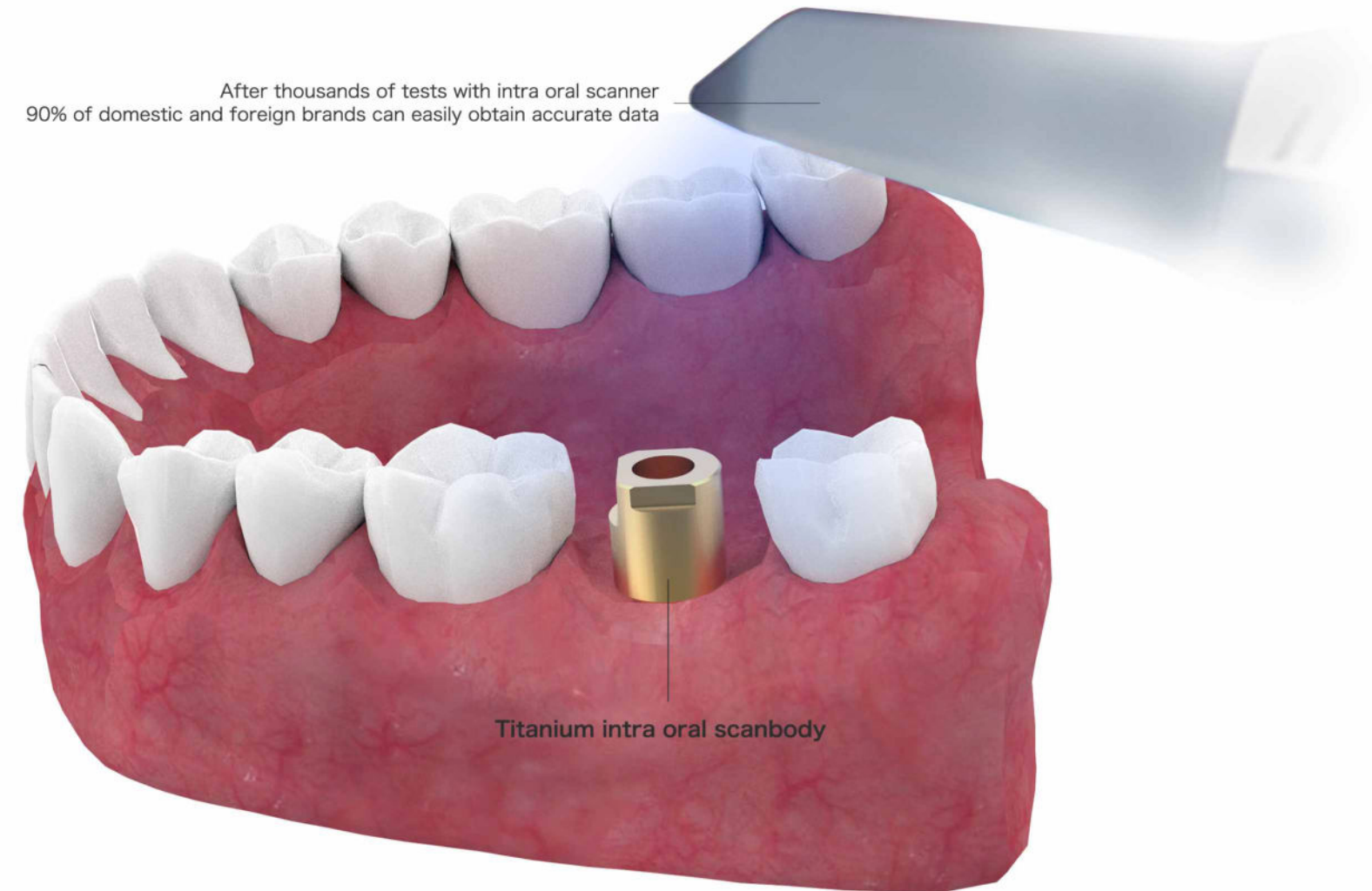

Titanium intra oral scanbody

AIO System All In One Digital Solution

✓ Multi functions in one abutment ✓ No restricted mouth opening anymore

The AIO System is the new all-in-one digital solution for implants. It allows the technician to intervene earlier in the doctor's implant case and the doctor & technician to work more closely together. The healing abutment, transfer, the impression coping and the intra-oral scan body all combine to save money on implant accessories. Whether the dentist uses intraoral scanning or conventional impression taking, it is easy to use and makes implantology more precise. The simple treatment process saves time and effort and reduces the patient's stress.



combine healing and data transfer functions in one abutment

- No scanbody
- No transfer
- No healing abutment
- No analog

New Full Kit

Easy to collect Precision manufacturing with multiple holes High temperature and autoclave resistant Meet conventional healing and transfer

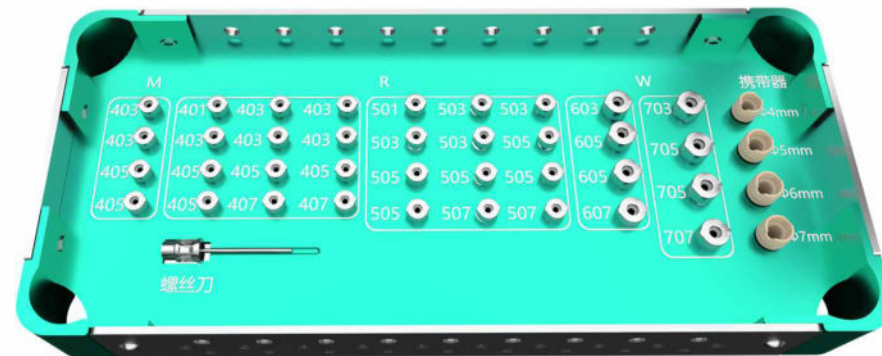

Meet conventional healing and transfer needs

Positioning points



Note: Positioning points correspond to gingival high

Scannable grinding abutment

Reduce the cost of components consumption

scanning and grinding two in one abutment
cost-effective abutment

Product Introduction

Scannable grinding abutment is a two-in-one multifunctional abutment for scanning and grinding, with scanning function in the form of scanning rod recognition on top. After completing the scan, you can directly match the library for abutment design. Combined with the number of data identification areas can achieve rapid selection. Titanium nitride coating is anti-corrosion and wear-resistant, anti-scanning reflection, with data identification area for accurate scanning. Scannable grinding abutment with upper grinding height of 7mm to meet routine restoration cases while reducing material depletion costs. 50+ brands, 70+ systems, 230+ sizes, complete system types and library, covering 90% of the market's implant systems, basically satisfying conventional cases. Scannable grinding abutment reduces the cost of material depletion, 2-in-1 function saves the cost of accessories, and with Mill T4 Pro X milling, it saves the cost of grinding time and reduces labor input, improving work efficiency for technical factories and clinics.



Distinguish gingival height according to the number of locating points

50+
Brand

70+
System

230+
Size

Vacuum titanium nitride coating
High strength anti-corrosion and wear resistance

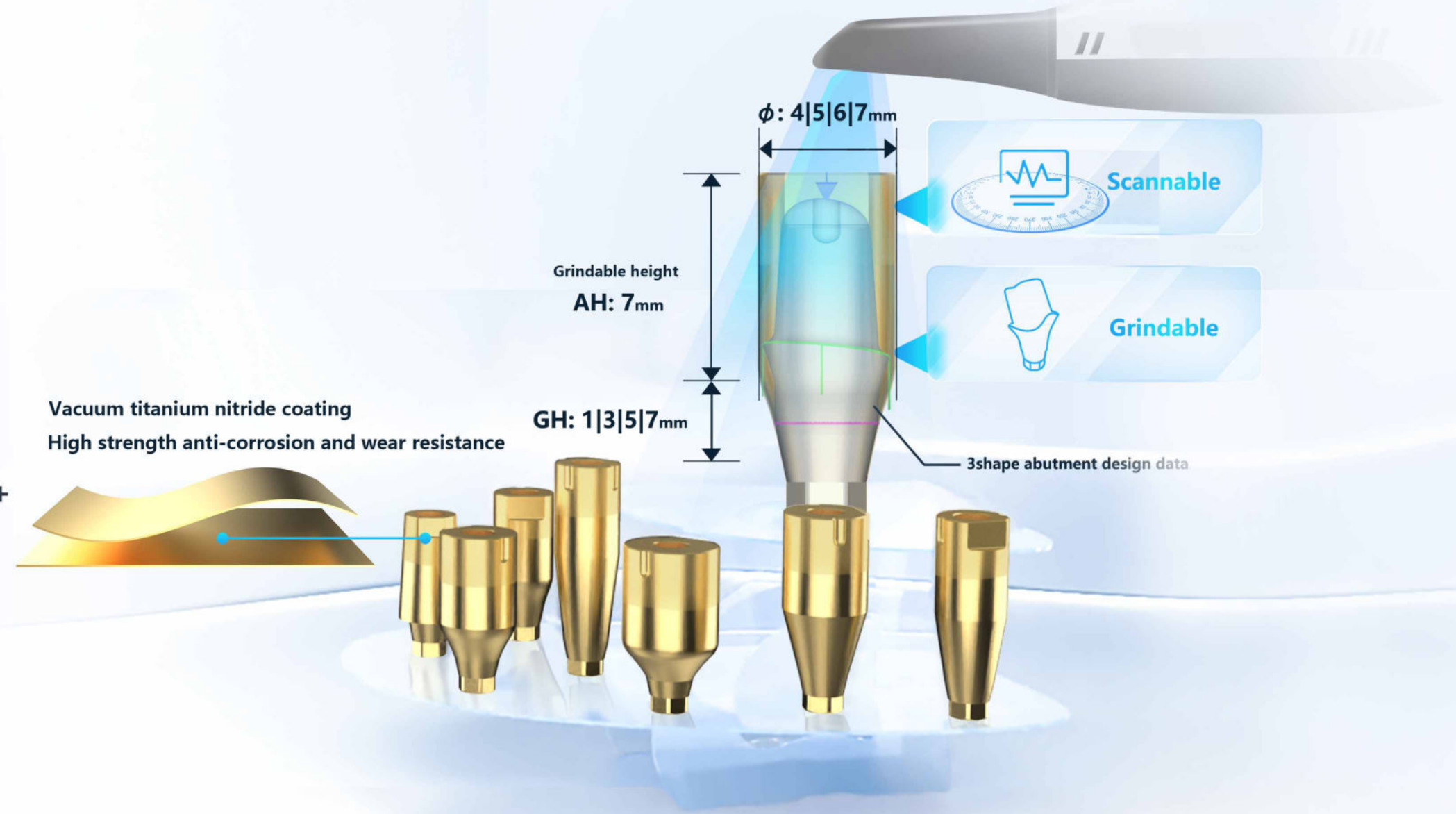

multi scanbody for edentulous

Apply to multi unit abutment restoration cases

M6 multi scanbody set could be used in oral to get digital impression for multi tooth loss and edentulous cases, it applies to the multi unit abutment restorations. This scanbody set simplifies implant surgery, improves efficiency and decreases treatment cost by the special identified notches and notch designed nodal which avoid the intraoral scanning distortion problem. This MU scanbody set applies to 99% edentulous case and multi tooth loss case. Made by medical grade IV titanium, NiTi coated, SLA surface treatment, the scanbody set does not deform under high frequency autoclaving steam sterilisation, and keep high strength, oxidation and corrosion resistant. Does not deform under high frequency autoclaving steam sterilisation, and keep high strength, oxidation and corrosion resistant.

- avoid scanning distortion problem
- 180 types usages
- applies to 99% edentulous & multi tooth loss cases
- precise scanning
- long serve life

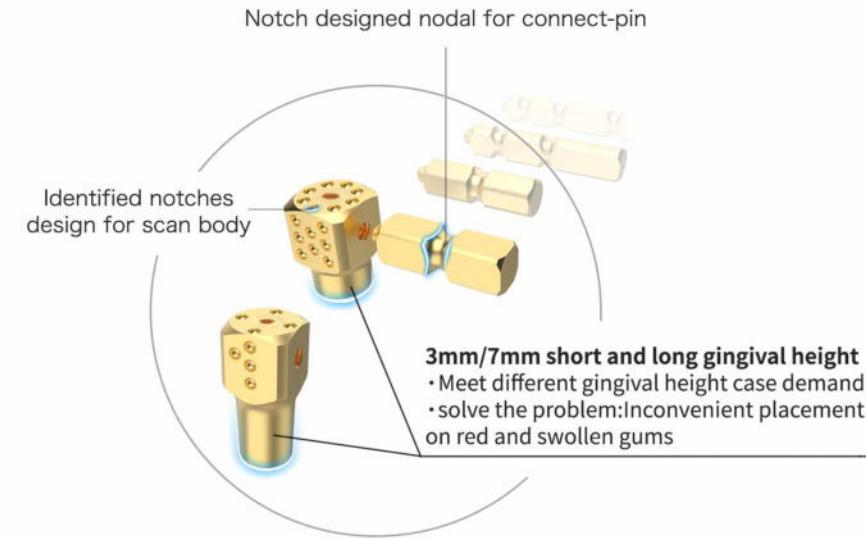

connect-pin in 3 different lengths

Choose the right length pin according to the distance between implants.

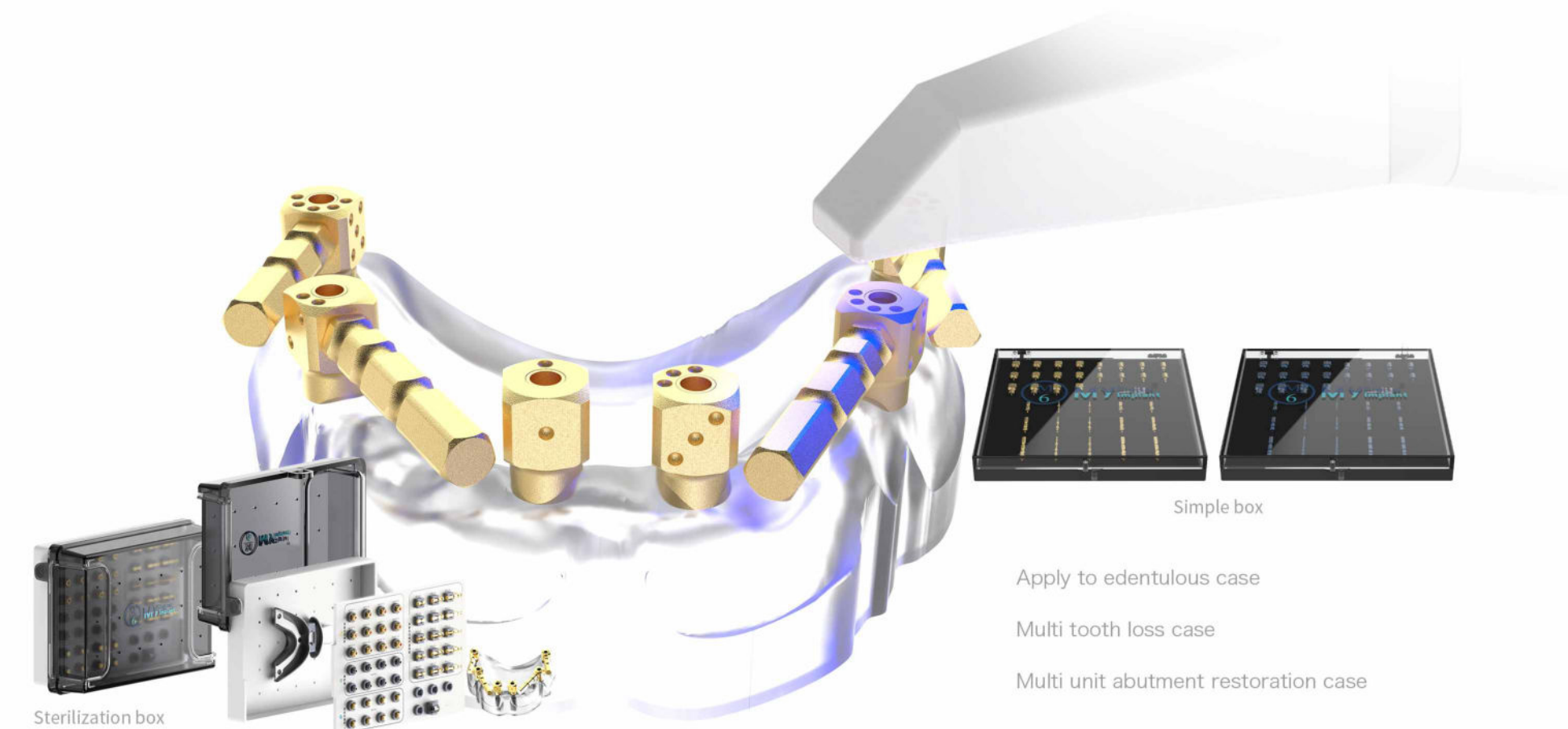

connect-pins in 5 different shapes

With the identified different notch designed nodal, scanning continuity could be acquired.



12 types scan bodies

Different identified notches avoid scanning distortion when scan similar structure.

Simple Box

Recognize different systems with different color

NF001-B Golden

Compatibility: Osstem, Noble, ITI, ICX, Adin, B&B, C-tech, Neobiotech, Zuga, Cansun

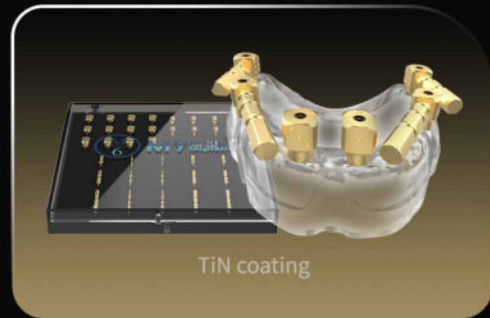

NF003-B Blue

Compatibility: Dentium, Zimmer, Cowell

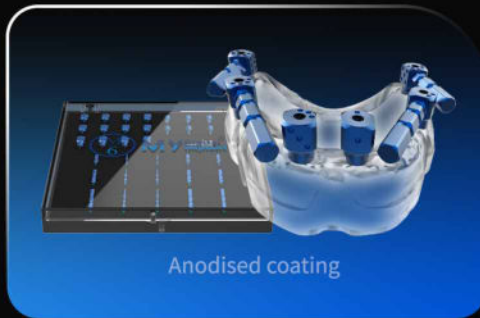

NF090-B Purple

Compatibility: MEGAGEN

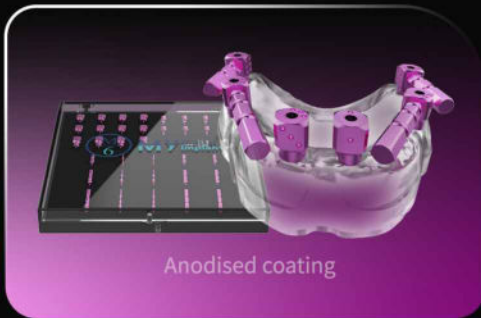

NF033UF-B Green

Compatibility: DIO UF

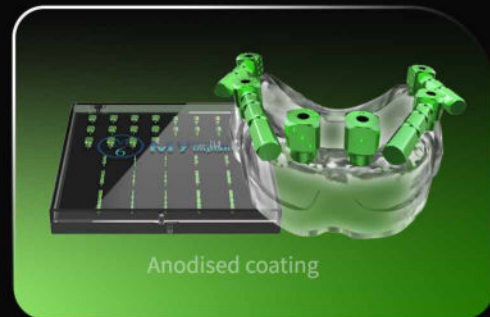

NF008-B Cyan

Compatibility: MIS

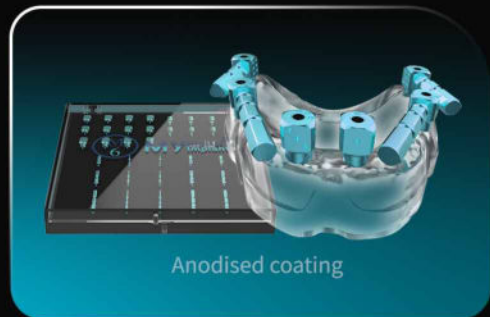

Scan body

8pcs scan bodies with short gingival height
4pcs scan bodies with long gingival height
Connect to MUA



Opposite scan body

Extra-oral scanning Save patients' time
Apply to case that temporary restorations can be passively seated
Improve treatment experience

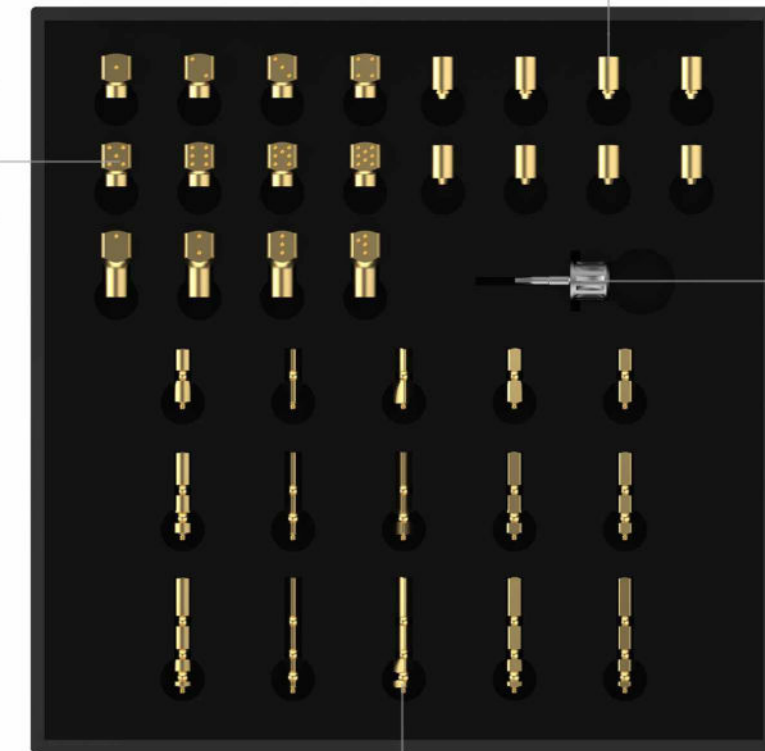

Final screwdriver



Connect-pin

According to space between implants and identified notches, choose the right scan bodies



Precision restorative parts



Titanium premilled abutment

✓pre-milled interface✓machined with grade IV titanium material

M6 Titanium pre-milled is made of top quality grade 5 titanium material.Processed by imported CNC machines from Japan,our premilled blank has high precision .

Pre-milled blank comes with fabricated interface to make custom abutments.M6 premilled has diameter 10mm and 14mm that allows CAD-CAM artists to produce abutments within certain angulation.

M6 pre-milled has dual interfaces that is workable for different machines.We provide users with adapted holder that realizes unique technique of "link-less" process., by means of the CAD-CAM technicians have no need to grind manually the connected par which was still typically seen in the industry .This advantaged one-mill solution helps to decrease the deviation caused by manual grinding ,it increases the efficiency of laboratory technicians.

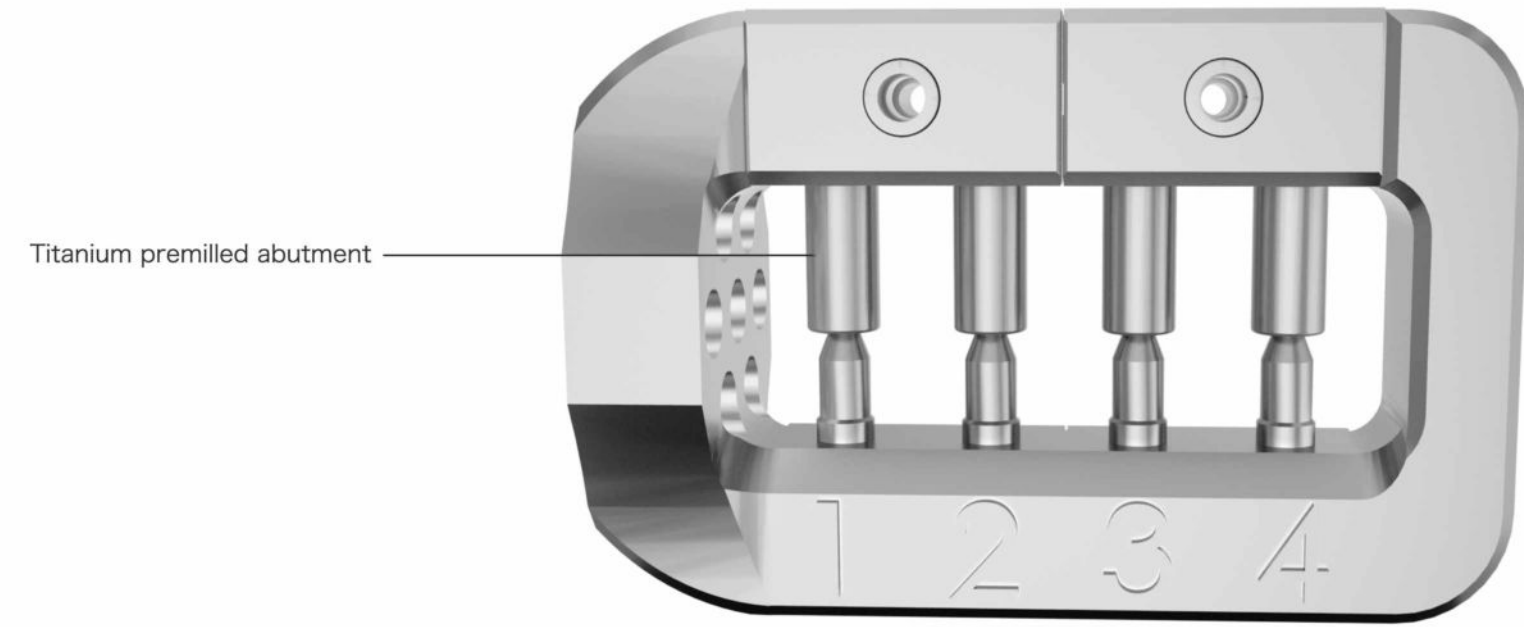
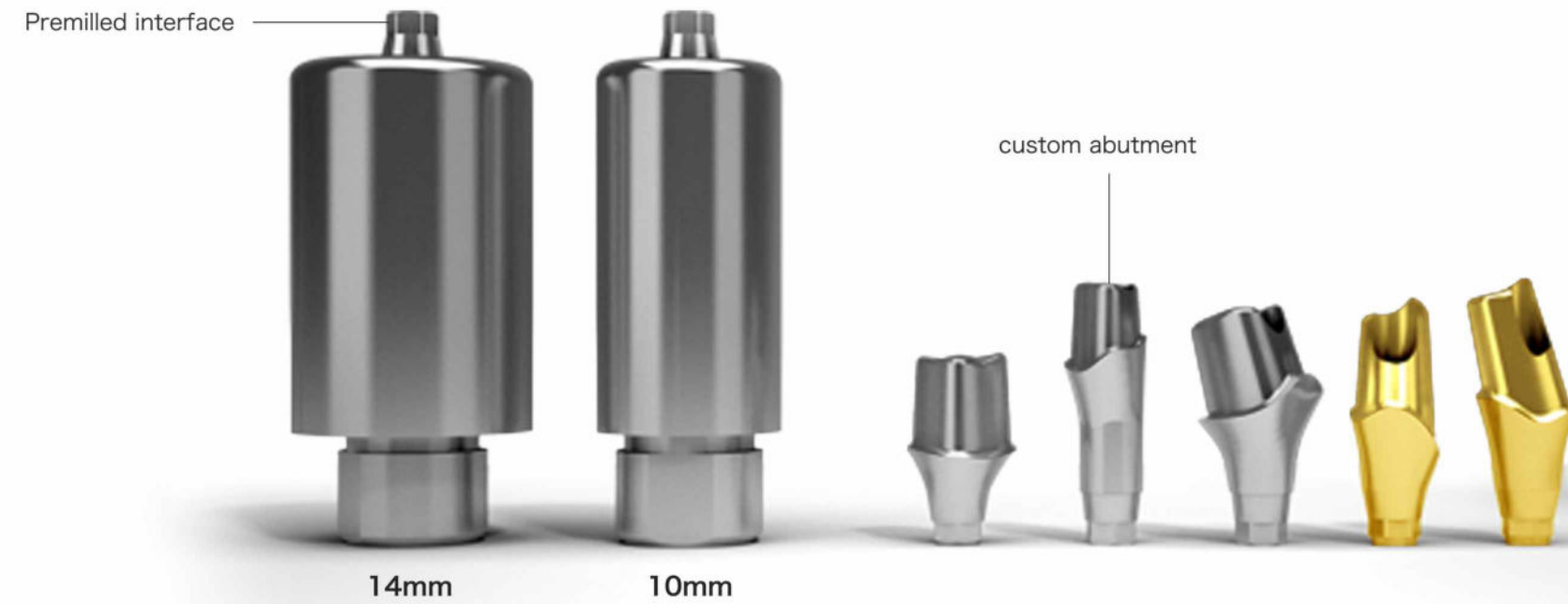

Use Mill T4 Pro, regular and reverse jig are available, Link-less milling with reverse jig,precisely milling

Scannable grinding abutment

Reduce the cost of components consumption

scanning and grinding two in one abutment
cost-effective abutment

Product Introduction

Scannable grinding abutment is a two-in-one multifunctional abutment for scanning and grinding, with scanning function in the form of scanning rod recognition on top. After completing the scan, you can directly match the library for abutment design. Combined with the number of data identification areas can achieve rapid selection. Titanium nitride coating is anti-corrosion and wear-resistant, anti-scanning reflection, with data identification area for accurate scanning. Scannable grinding abutment with upper grinding height of 7mm to meet routine restoration cases while reducing material depletion costs. 50+ brands, 70+ systems, 230+ sizes, complete system types and library, covering 90% of the market's implant systems, basically satisfying conventional cases. Scannable grinding abutment reduces the cost of material depletion, 2-in-1 function saves the cost of accessories, and with Mill T4 Pro X milling, it saves the cost of grinding time and reduces labor input, improving work efficiency for technical factories and clinics.

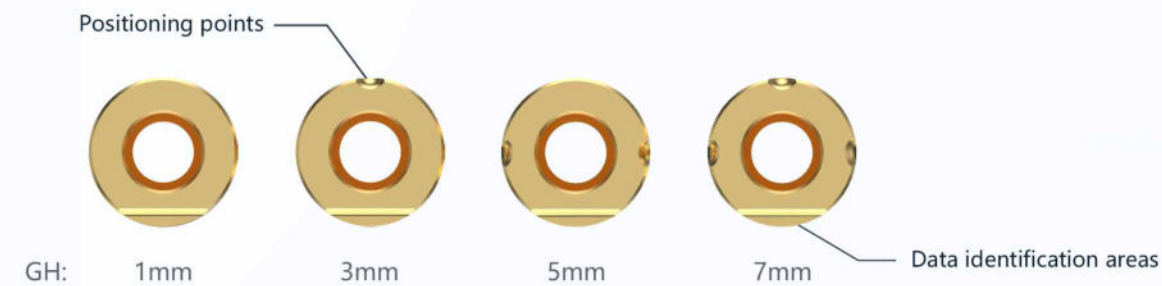

Distinguish gingival height according to the number of locating points

50+
Brand
70+
System
230+
Size

Vacuum titanium nitride coating
High strength anti-corrosion and wear resistance

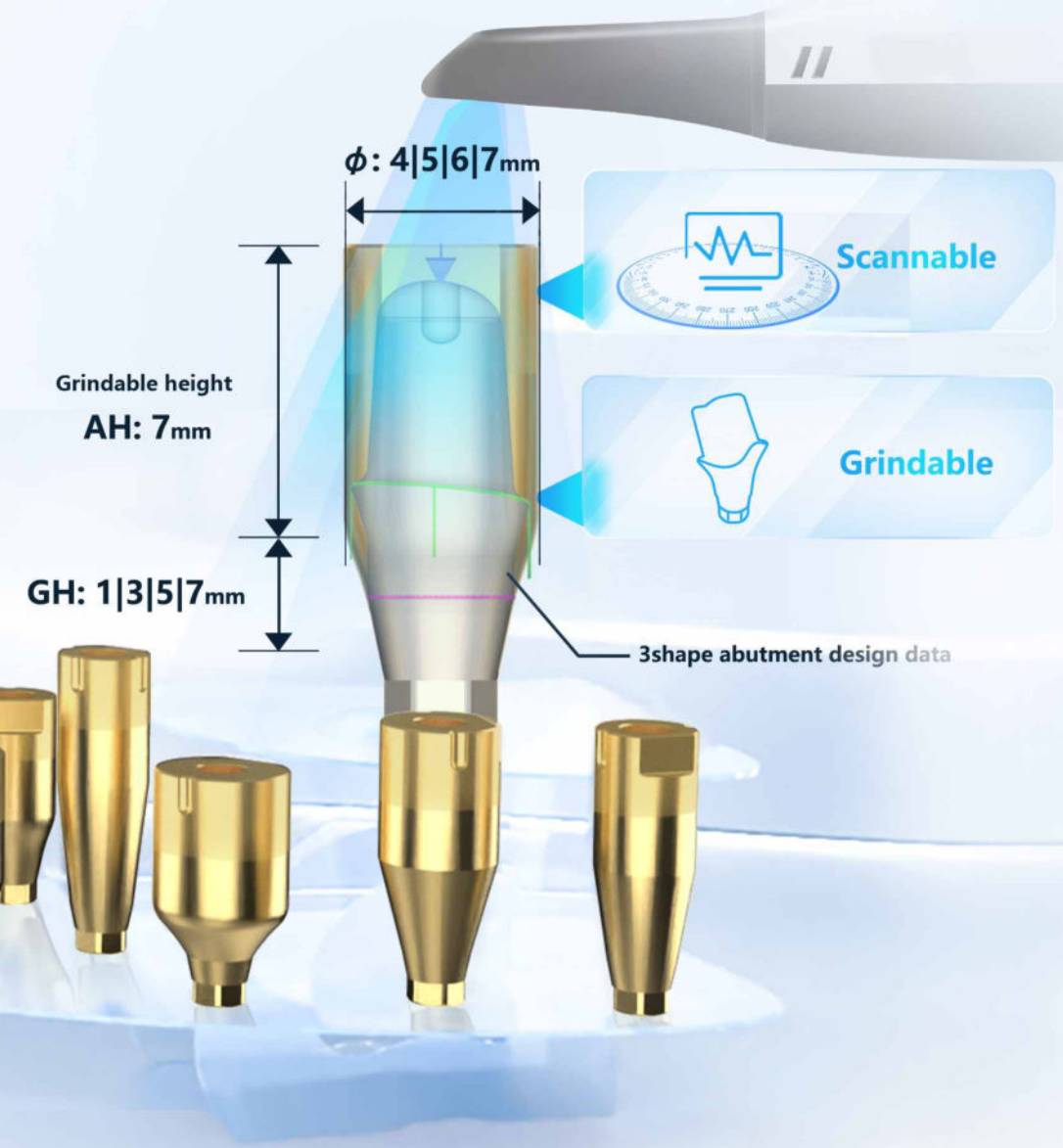
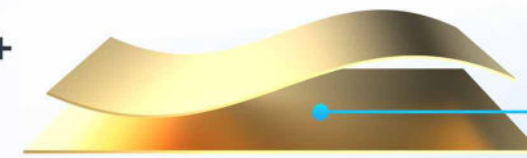

M6 - Multiunit

- ✓single-implant restoration
- ✓multi-implants restoration
- ✓edentulous implants restoration

Suitable for screw-retained multi-tooth restorations, ideal for use in the All-on-4 treatment concept, simplifying the restoration of divergent implant angles. Straight and angled (17° and 30°) alternatives, with optional gingival height, various abutments available for the implant system, with handles for easy placement. The upper part can be cast as a cylinder.

- easy to install and maintenance
- protect tissue
- balance force
- immediate loading



collar height according to patient
G/H:1.0/1.5/2.0/2.5/3.0/3.5/4.0/5.0

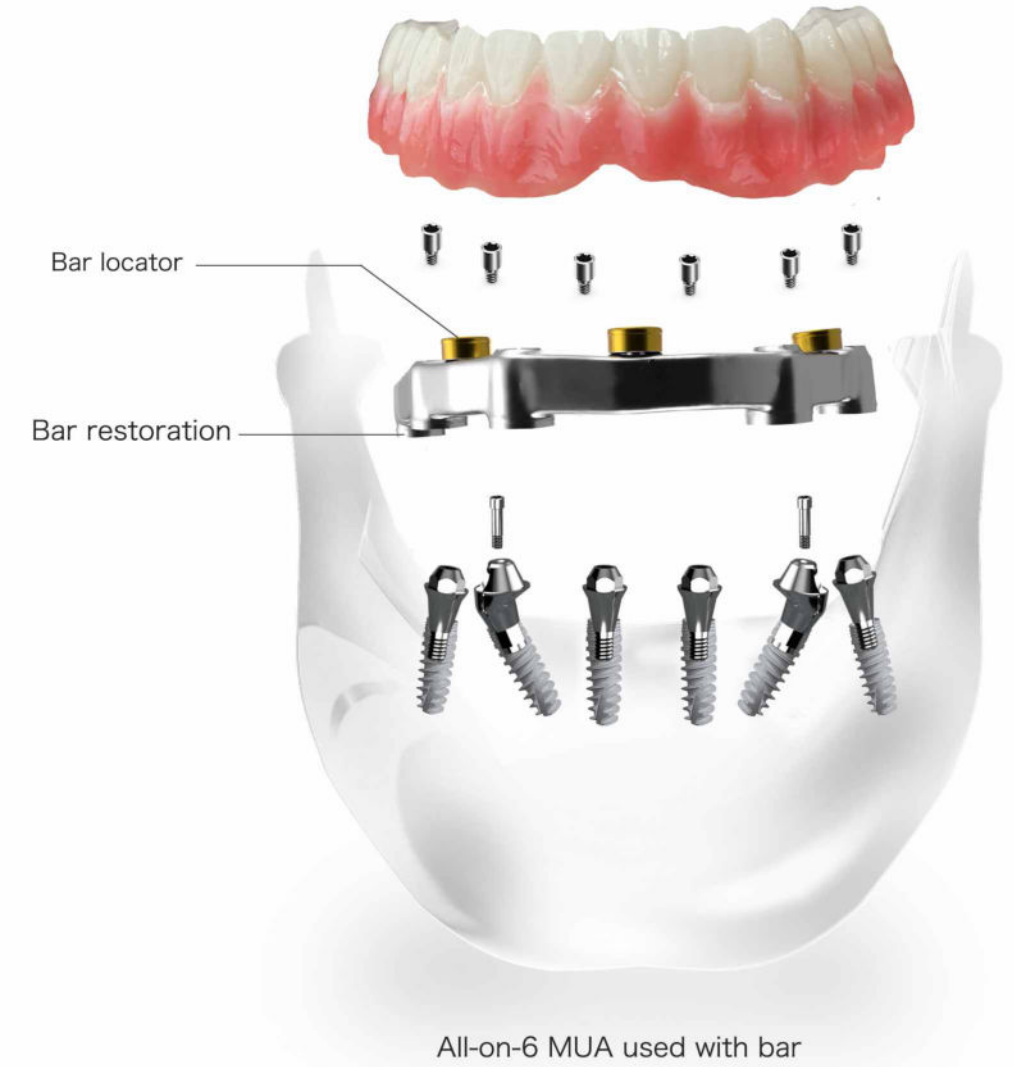
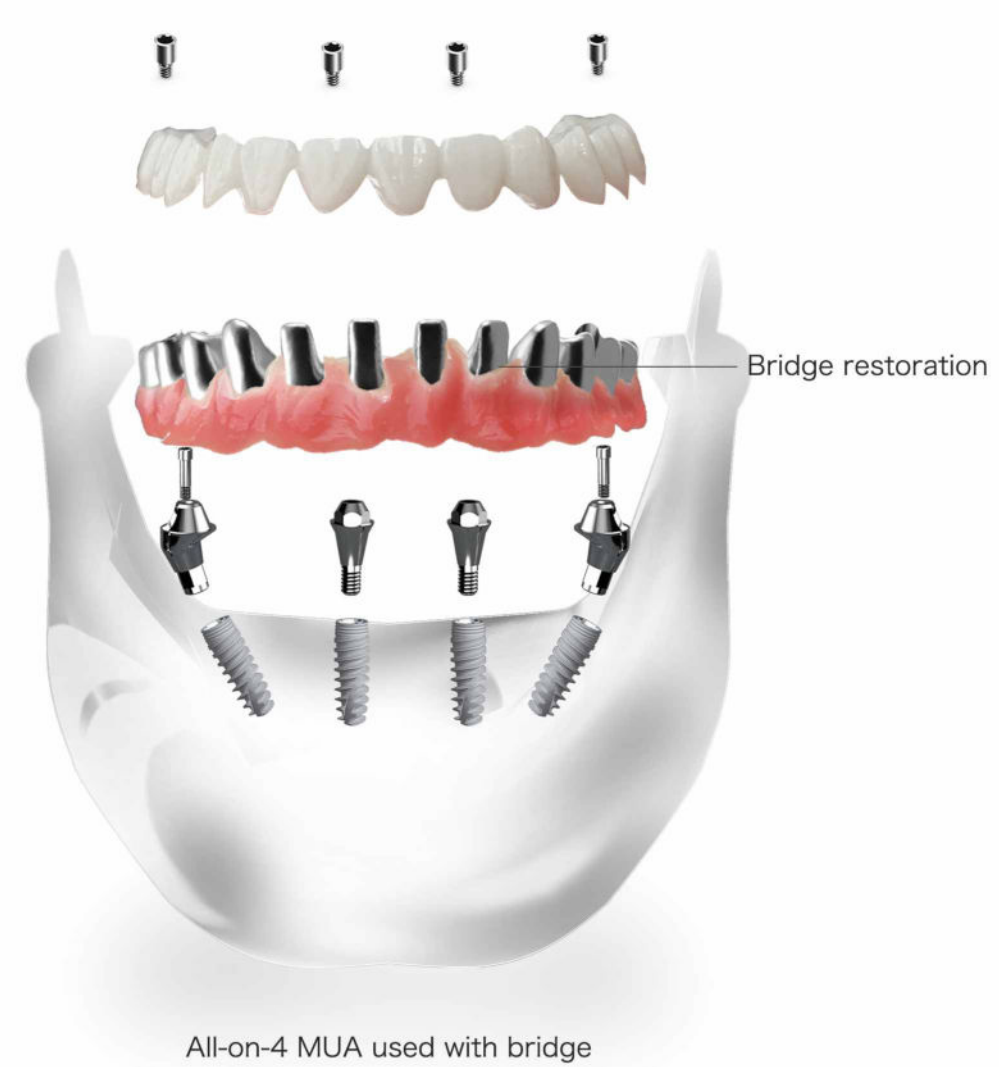

Multi Conical Universal Screw

Provisional restoration | Replace temporary abutment | Save cost | Shorten workflow | ZAPP Gr5 titanium

M-CUS (Multi Conical Universal Screw) applies to provisional restoration, made by grade V titanium material from ZAPP, sturdy and durable; Self-locking conical connection structure (Morse taper), replacing temporary abutments and saving cost; one for multiple brands, compatible with multiple mainstream systems.

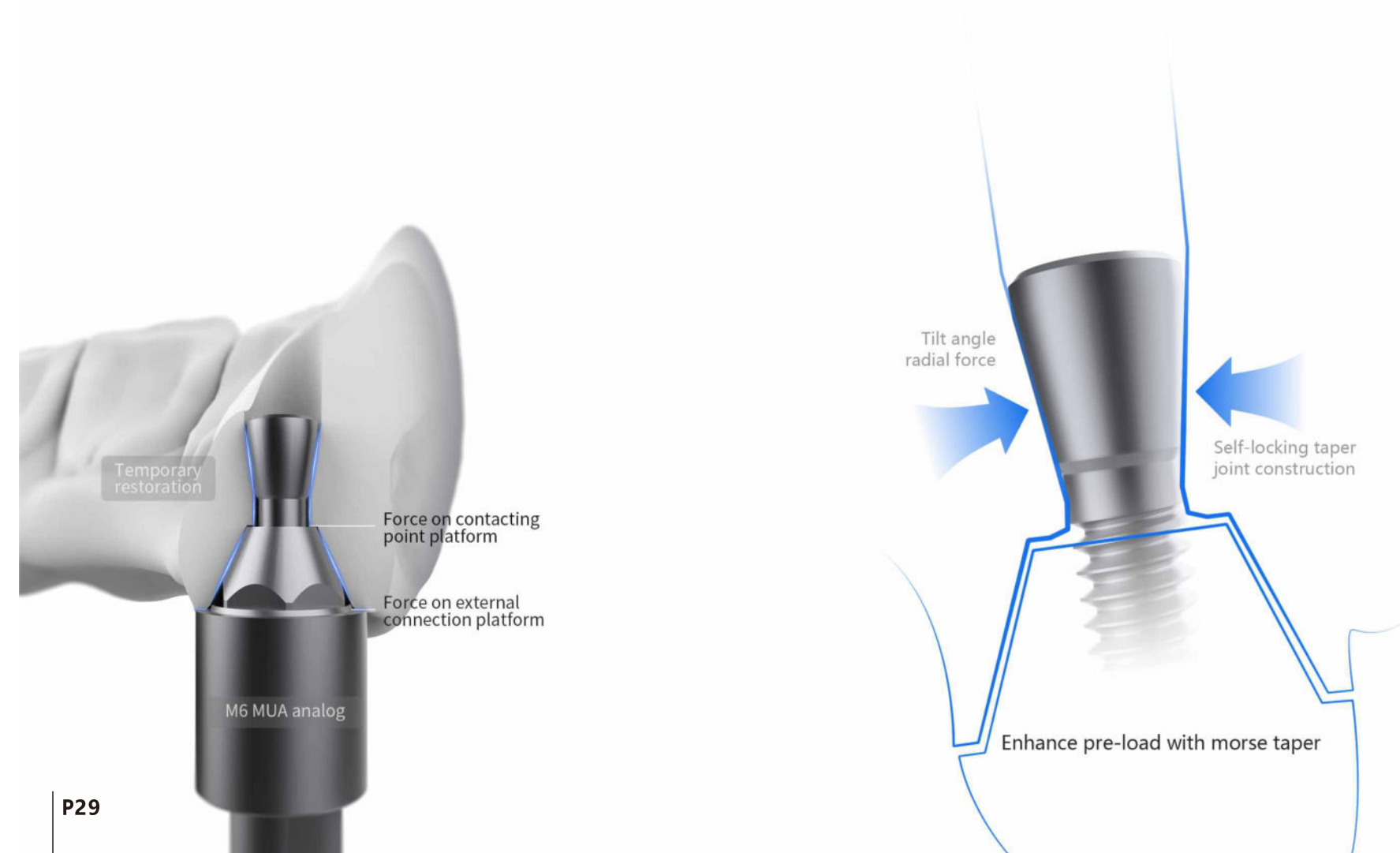

Germany ZAPP grade V titanium material
Wide compatibility

One screw for multiple brands
Quick selection | Easy management

M1.4
Osstem, Noble, Straumann, ICX, Anthogyr, Adin, B&B, Cortex, C-tech, Neobiotech, Zuga, Cansun, Dentis, SNUC, Neodent, CRS, Thommen, Megagen, Bioconcept, Astra, Bio-horizons, AB

M1.6
MIS

M1.8
Dentium, AlphaBio, Zimmer, CWM

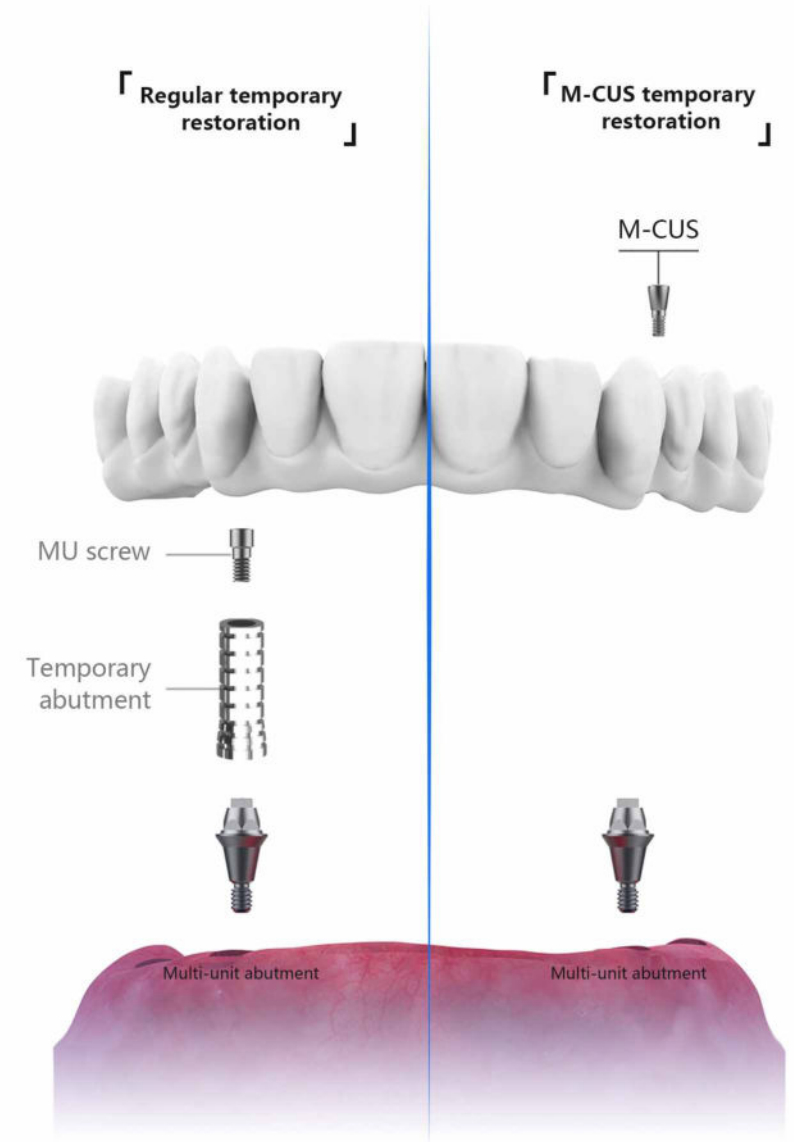

Easy-Implant overdenture abutment

- ✓ Half-arch restoration ✓ Full-arch restoration
- ✓ Bar restoration ✓ locator & MUA restoration

A flexible solution for the restoration of implant removable dentures. The plastic carrier for the abutment makes it easy and safe to manipulate the abutment and check alignment intraorally. The lowest vertical height in the world. Dual retention (internal and external retention for good durability) easy insertion (precision alignment using self-positioning design) extensively adaptable KERATOR elastic attachment. 15° angled abutments can be used for non-parallel implants. In combination with the use of the extended anode also corrects over 40 degrees implant. The KERATOR metal base has good retention properties deep into the denture to improve the polymerisation of the denture resin.

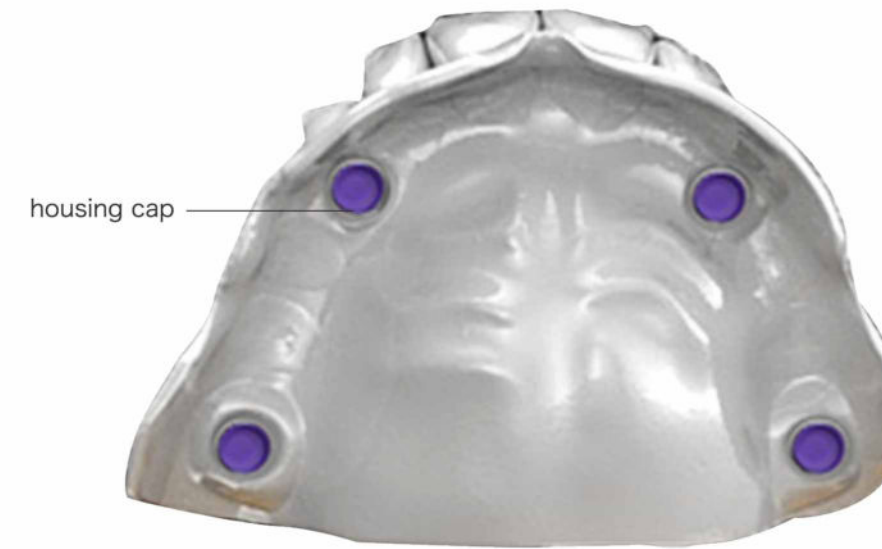
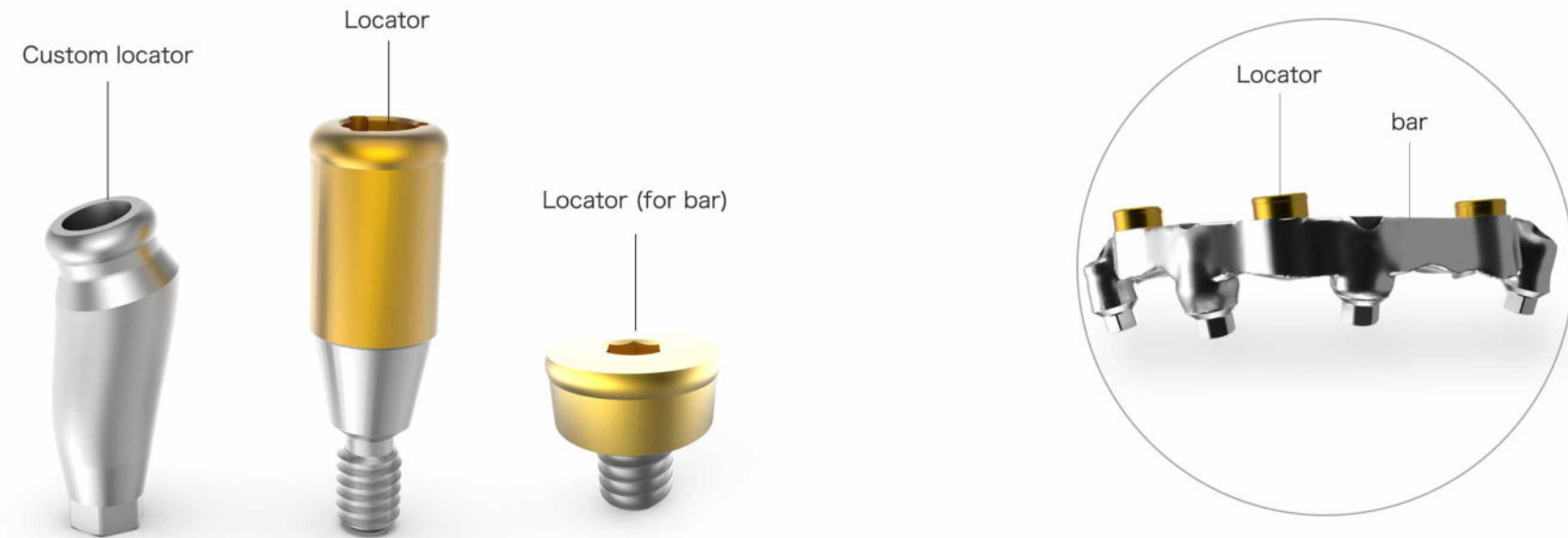

- **low cost for treatment:** fewer implants (at least 2 implants)
- **Simple workflow in surgery:** no need for bone augmentation and soft tissue grafting
- **Wide application:** prosthetic restorations for patients with maxillofacial defects and prostheses for patients undergoing radiotherapy
- **Esay maintenance:** patients could remove and clean the denture by themselves
- **Strong retention:** compared to traditional full arch denture, implant-supported denture have stronger retention, could meet patients' needs.
- **Aesthetic restoration:** the use of porcelain and adhesive rests can effectively provide support for the soft tissues on the buccal side of the lip and achieve a certain aesthetic restoration.

Stock abutment

- ✓Top Gr5 titanium ✓Independent R&D
- ✓Precision machining with CNC machine

The stock abutment is pre-milled in diameter, gingival height and the interface for direct implant restoration. It can be milled into custom abutment with the Mill T4 Pro X milling machine. 16 abutments are clamped at a time with high quality, high precision and high efficiency, saving time and effort. Solve the problem of inverted concavity of stock abutment and improper grinding of shoulder. It can also be simply grinded by hand to fit the natural contour of the teeth for aesthetic restoration.

The abutment diameter basically matches the cervical diameter of the tooth, and quick selection can be realized by healing the abutment diameter and gingiva height, and the application is simple and efficient.

0°stock abutment

angled stock abutment



Could be grinded according to different cases

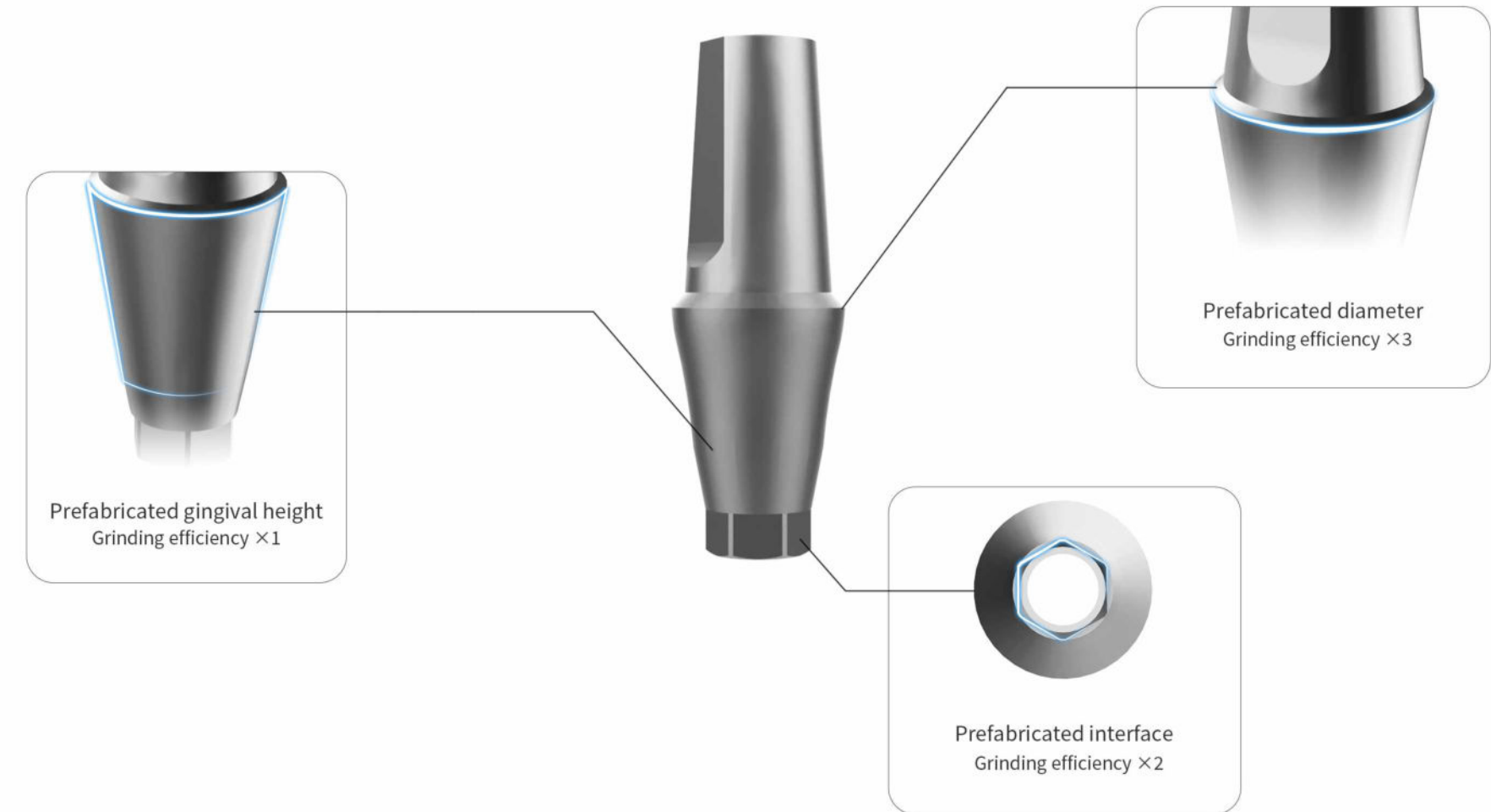

Ti-base

BASE Aesthetic restoration of partial tooth loss & smile that leaves no trace

M6 Ti-base is made of top quality grade 5 titanium. With fabricated interface on bottom, minimum 6mm working height, mean it can be directly cemented with zirconium crown after manual grinding.

M6 Ti-base comes with CAD library that supported CAM grinding. Dual modes favorites different users. Our Ti-base are classified into engaging and non-engaging, non-engaging type are popularly used for full-arch structure. M6 Ti-base attracts big number of users from United States, majority countries in South America, all countries in Europe, Middle East area and other Southeaster countries.

✓ **temporary crown restoration**

BASE+ Resin temporary crown

✓ **permanent crown aesthetic restoration**

BASE+ zirconia inner crown+zirconia/emax crown



Base
Ti-base

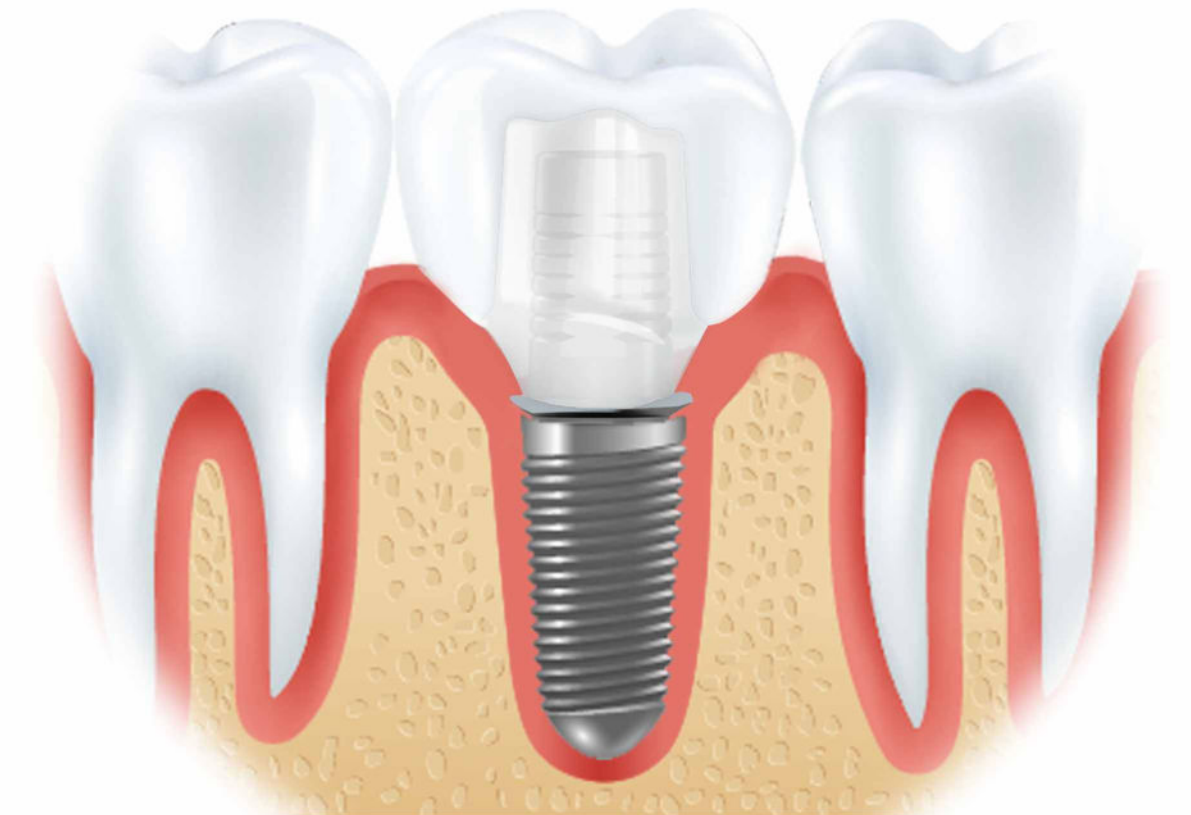

Abutment Screw

The M6 abutment screws are made from top quality titanium alloy for medical use, manufactured in Germany. They are subjected to rigorous flaw testing. The screw is perfectly matched to the abutment and has a torque value well above the clinical requirements, which guarantees successful implantation.

- Strict torque test
- International standard precision
- Good material
- High safety

Top quality titanium alloy for medical use manufactured in Germany, subjected to rigorous flaw testing.



50+ brand
70+ system
220+ Model



DLC coating -diamond like carbon coating(Black screw)



Physical picture



DLC coating is the abbreviation of Diamond Like Carbon coating, which is a type of amorphous carbon thin film with properties similar to diamond, including high hardness, unique tribological characteristics, high resistivity, and excellent optical performance. It is widely used in medicine, aviation, machinery, electronics, optics, thermology, acoustics, and other fields.

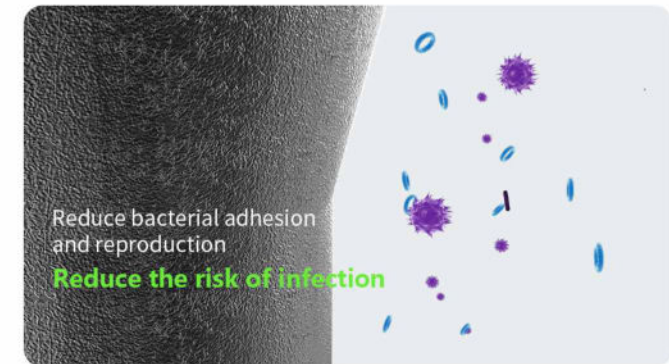
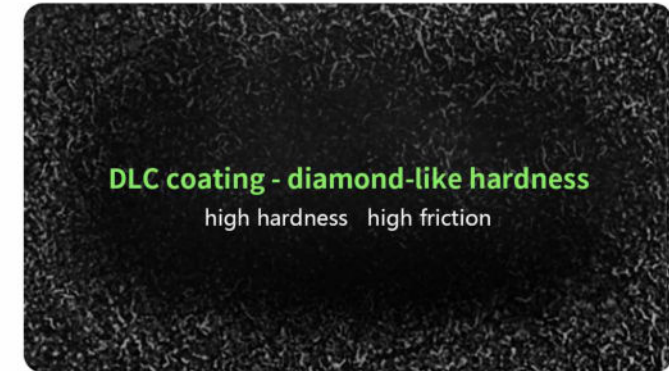

3D Analog

- ✓All-round anti-rotation✓Guide angle design✓Chip removal groove design
- ✓Double vertical groove design✓Accurate simulation✓Durable

Newly designed digital analog is an important part of the digital dentistry, it applies to the digital dental model (3D printing, milling) . Complete library is provided. Digital model can be design and produced with library of digital analog. Repositioning and precise positioning with two-piece design, our digital analog can be removable and reused, assure accurate design, the removable artificial gums can repositioning. All-round anti-rotation. The guide angle design guides the installation of digital analog into position, and solves the problem of debris build-up on resin model; the dual vertical groove design upgrades the anti-rotation, and with the digital analog carrier, the blind installation is possible. The digital analog retains the application characteristics of the lab analog, and combines the precision of the intra-oral scan body and the accompanying library to replace the application of the traditional process.

All-round and multi-angle anti-rotation design
Ensure accurate data

Guide angle design
Guides the installation into position
Solve the problem of resin model debris accumulation

Chip removal groove design
Stores debris from resin model resulting from installation
More accurate data

Repositioning and precise positioning with two-piece design, our digital analog can be removable and reused, assure accurate design, the removable artificial gums can repositioning.

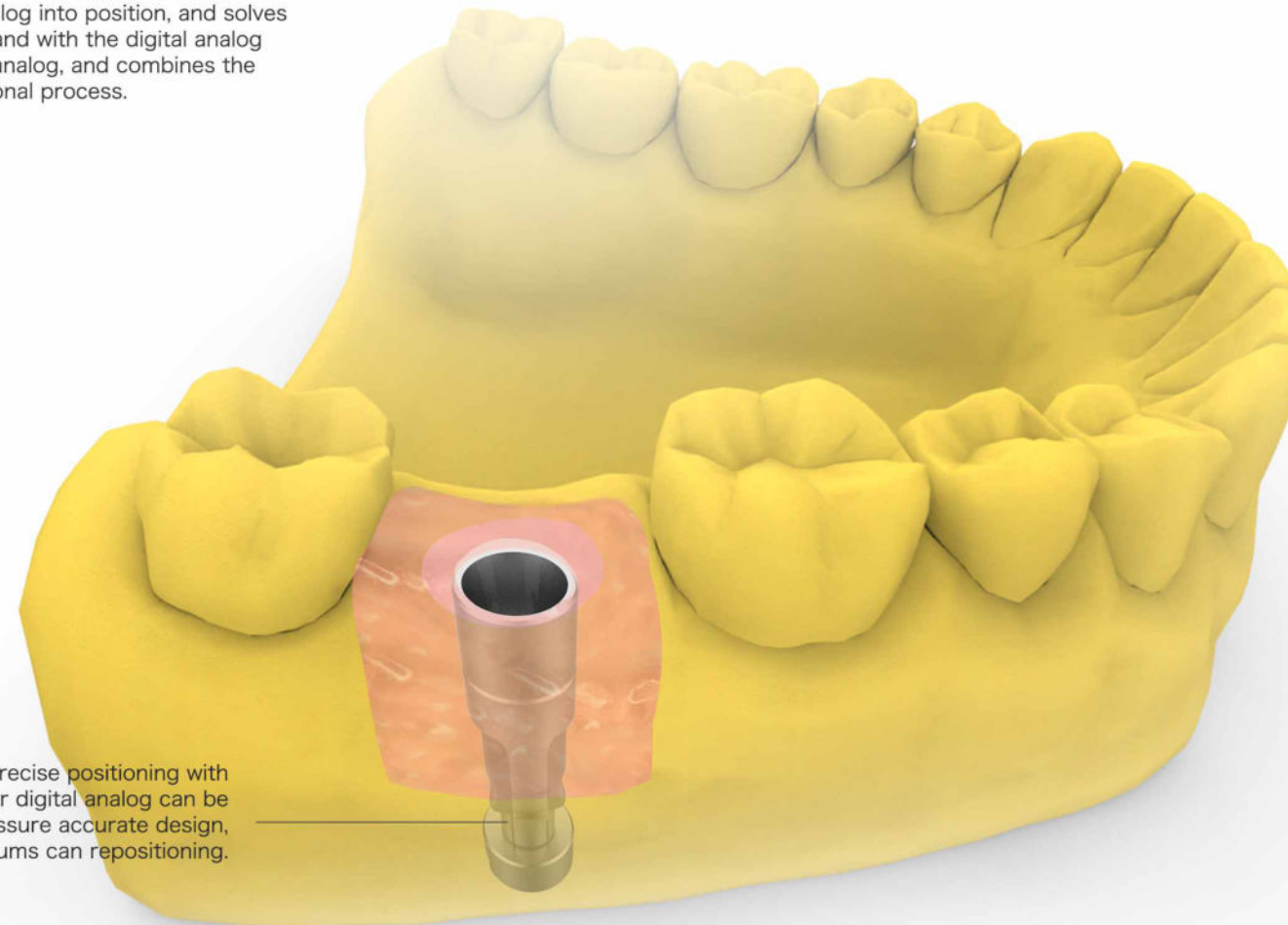
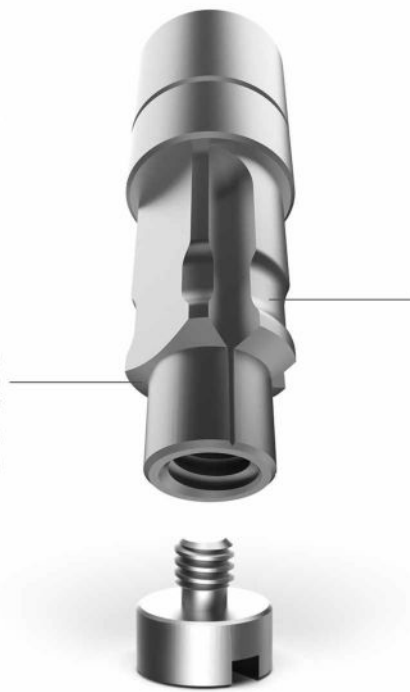

Elevation view of the 3D analog

Top view of dental model (assembly interface)

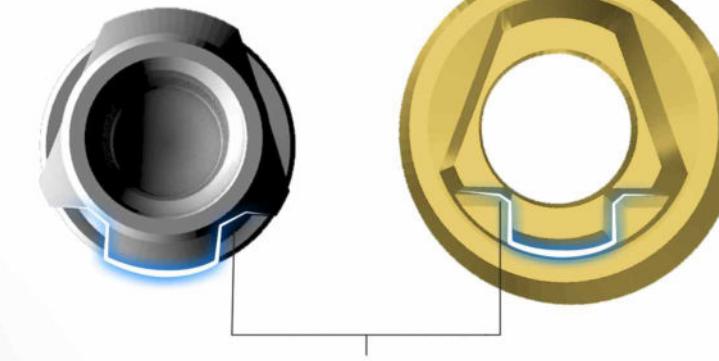

The dual vertical groove design enables easy installation
upgrades the anti-rotation, and with the digital analog carrier, the blind installation is possible, the installation is more easier.

3D dental analog carrier



M6 Analog

Apply to dental stone model

The M6 implant replacement is made of stainless steel with high hardness and corrosion resistance, which reduces the wear and tear rate. It has a good finish and dimensional accuracy and accurately reflects the internal dimensions of the implant. It can be fitted to the transfer bar and buried in the working model.



Dental analogs display

High-strength medical stainless steel with high hardness and corrosion resistance to reduce wear and tear



Anti-rotational design accurate simulated



good finish and dimensional accuracy and accurately reflects the internal dimensions of the implant. It can be fitted to the transfer bar and buried in the working model.

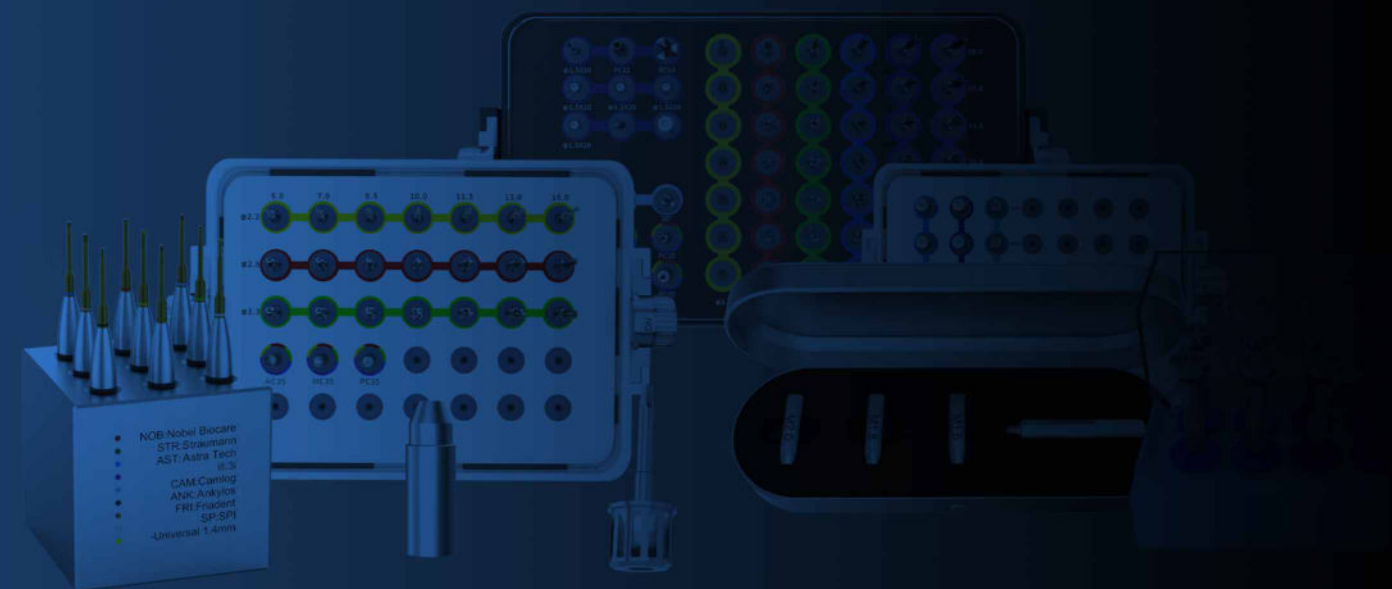

Innovative planting tools



A: Half-cover surgery guide kit

For universal surgery to prepare implant hole

A kit is universal surgery kit, applies to implant surgery with surgery guide. It is different with regular kits, the implant passage constraint by means of the guide pin allows the drilling to form a fixed direction and depth of the implant passage for guidance purposes.

The smaller parameters combined with the step-by-step preparation process result in less heat generation and more precise preparation of the cavity, which can also be adapted to a wider range of implant types.



A kit- stopper with clamping design

For the drills with $\phi 3.5\text{mm}$ guide post, we design a clamp-on stopper, it is based on the principle of tool clamping in the machining industry. The slotted part will produce an elastic contraction so that the drill can be inserted into the stopper with a true 0-swing to reduce angular errors. And reduce multi errors in surgery guide without a sleeve.

The advantage of the clamp-on stopper is that once the drill is inserted into the stopper, it is not easy to fall off. The stopper in traditional surgery kit has a handle, so when using it, you need to hold the handle with one hand and prepare the implant hole with the other hand, but our clamp-on stopper could free one hand of the operator and make the operation more convenient.



A: Half-cover surgery guide kit

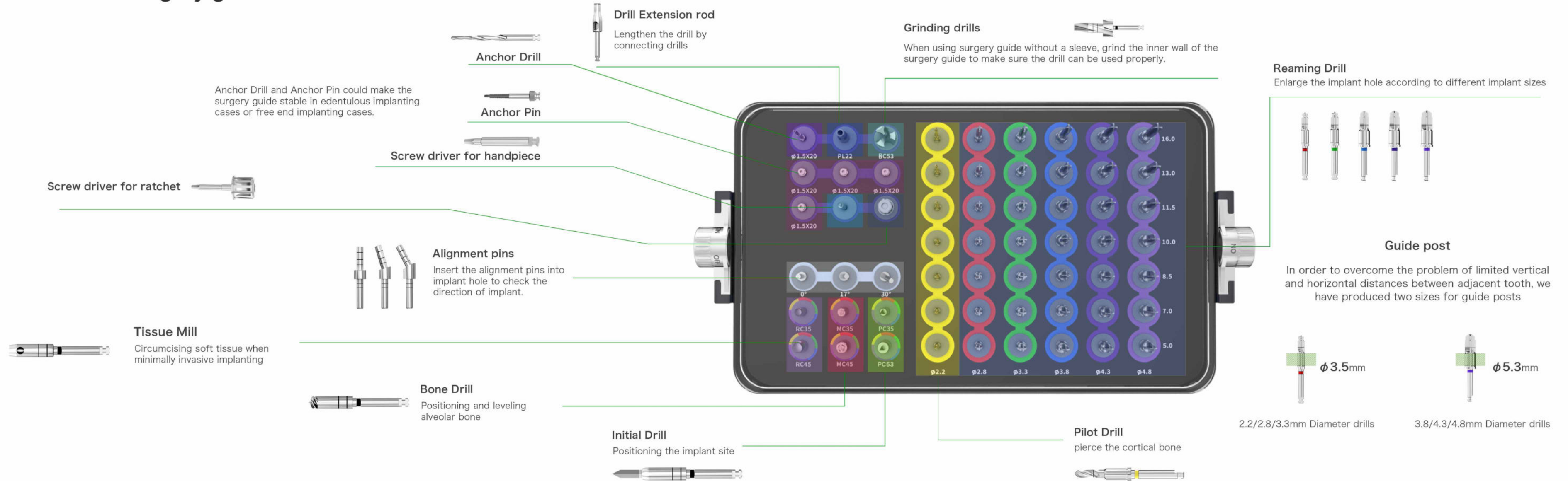

B: Implant placement tool kit

Implant insertion kit for different system

A kit prepare implant hole+ B kit insert implant,
A+B kit could finish a full implant surgery

- locker
- Hard-taper cortical drill
- torque
- for handpiece
- for torque
- probe

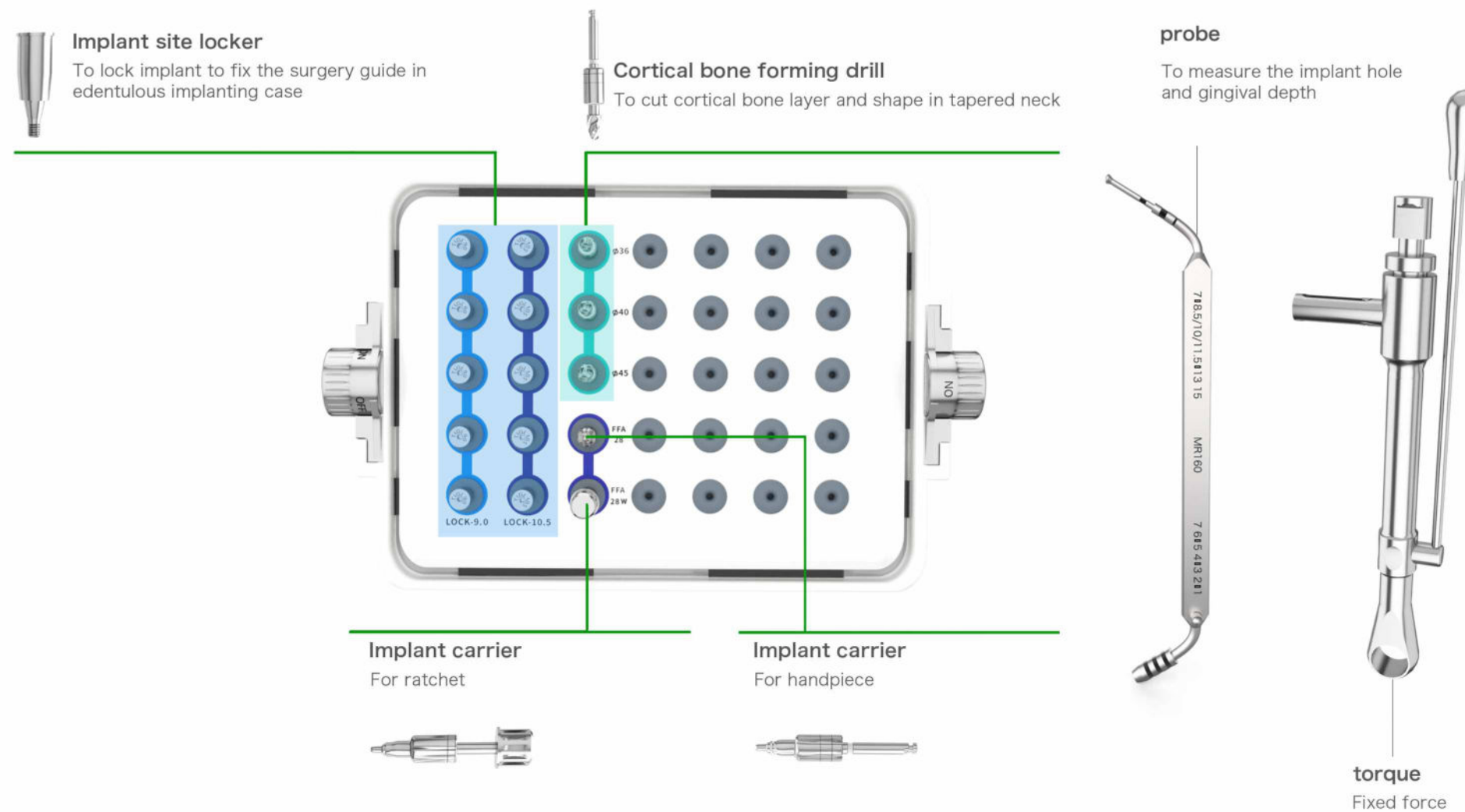

C: Simple Half-cover surgery guide kit

For universal surgery to prepare implant hole

For those who do not require as much guidance, a positioning guide can be used for positioning and depth, and the subsequent surgical procedure will be done by the operator's free hand. Due to the poor accuracy of the surgery guide, the operator's experience is also required. The smaller jump parameter combined with the step-by-step preparation process results in less heat generation and more precise preparation of the cavity, which is suitable for conventional implant models.

- Pilot Drill
- Extension Drill
- Initial Drill
- Tissue Mill
- Bone Drill

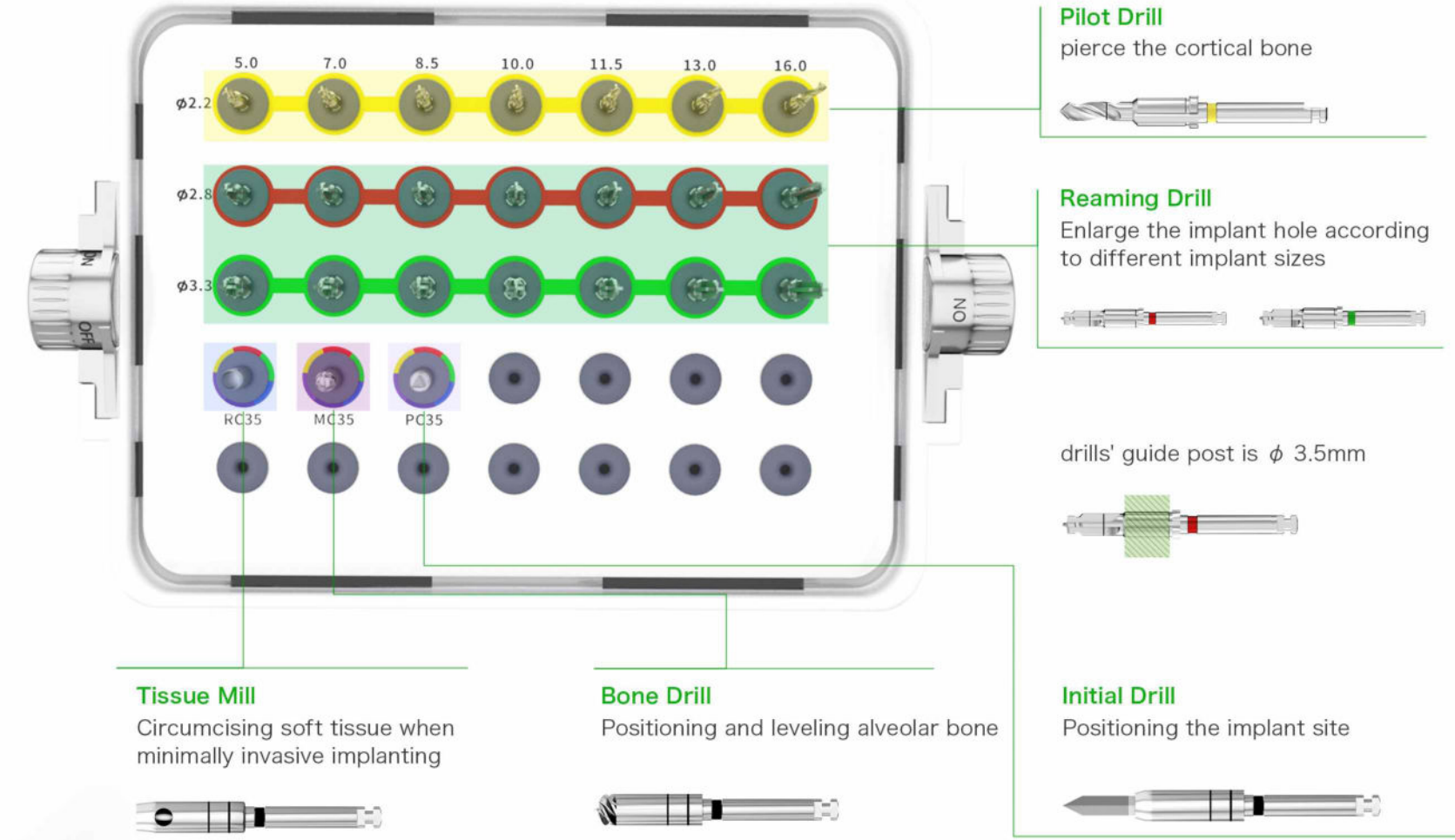

Carrier kit for 3D digital analog

“This set is enough”

Carrier for 3D digital analog



Full sizes one for multiple brands



Rotational collecting box-easy to select

Do no harm to screw channel of 3D analog extend service life of 3D analog

Thread structure design one for multiple brands



Make it easy to place and remove 3D analog in complicate implant position

Apply to different angle
Lossless interface
Connect quickly to implant position
Good helper for bulk placement



Carrier for 3D digital analog

Handle with SLA treatment/Aviation aluminum handle/Medical stainless steel screwdriver head/ Solid,durable,anti-corrosion and wear-resistant/Long service life/ Easy to place

3D digital analog

✓All-round anti-rotation✓Guide angle design✓Chip removal groove design
✓Double vertical groove design✓Accurate simulation✓Durable

Two-piece digital analog repositions, precisely position, position is adjustable, simulated design is precise, removable artificial gingival repositioning. Digital analog retains the application characteristics of the analog, combined with the precision of the intraoral scanbody and library, could replace traditional processes.

Full sizes One for multiple brands
compatible with most popular brands



Code	Implant brands compatibility
TA001	Osstem(TS/GS), Dentium (Super line), Dio(UF II), Astra (Osseo Speed-TX), Megagen(EZ PIUS), Dentis-R, Anker- (SB-I/SB-II/SB-III), Megagen(Anyone), NeoBiotech (IS), SG(SST/STT/SRT), SNUC, Bioconcept- (BV), Bioconcept-BV, ZIMMER (Azure), T Plus, Cortex (Classix Conical), INNO/CWM, CSM, ZENOIS, Leadoss(BL), Dentis-SQ
TA015	ITI Straumann (Tissue Level), Osstem(SS), Dentium (SimpleLine II), Bioconcept (BC-Tissue Level), Trausim (TL)
TA017	ITI Straumann (Bone level), Bioconcept- (BC) -Bone Level, CANSUN, Trausim (BL)
TA018	ITI Straumann (Bone level), Bioconcept- (BC) -Bone Level, CANSUN, Trausim (BL)
TA020	Nobel BioCare (Active), Dental Master(DM)
TA021	Nobel BioCare (Active), Dental Master(DM)
TA025	MIS(Seven), Zimmer(Tapered Screw-Vent), Bego(SC / SCX /RS /RSX /RI*1), Alpha-Bio(SPI), AB, Cortex (Dynamix), Biohorizons, Dentin (Classic/Prestige), Adin-Touareg-OS/S, Ratio, Implant direct legacy
TA041	Dio(UF II) -N, Astra (Osseo Speed-TX), Megagen(Mini), B&B-3.0
TA042	Astra (Osseo Speed-TX), ICX-4.0, Megagen(EZ PIUS), Anker- (SB-I/SB-II/SB-III) -N, Astra(OsseoSpeed™ EV), ZIMMER (Azure), Cortex (Classix Conical), CSM, Leadoss(BL)
TA050	Anthogyr (REG/PX), MIS(C1), Wego-N, CLC (CONIC)
TA131	Megagen(AnyRidge), B&B, C tech(EL)
TA147	ZUGA, Datsing(I), NEODENT (GM), Camlog (conelog)

Laser code to identify brands
 make replacement easy



Dental technician screwdriver kit

Use in Mill,use with dental models

Dental technician screwdriver kit has strong compatibility suit for multiple brands such as Osstem/Dentium/Megagen / NOBLE/ ITI/ ICX/ 3I/ Ankylos/ Astra /Zimmer. Lab art Screw Driver kit is made by medical alloy material that with equipped with ratchet structure and six contact area. That can balance stress, difficult to damage and stand wear and tear.

This screwdriver set could install stock abutment, tibase,titanium premilled abutment, custom abutment,MUA,AIO,custom MUA,customlocator,bar, bridge,healing abutment...

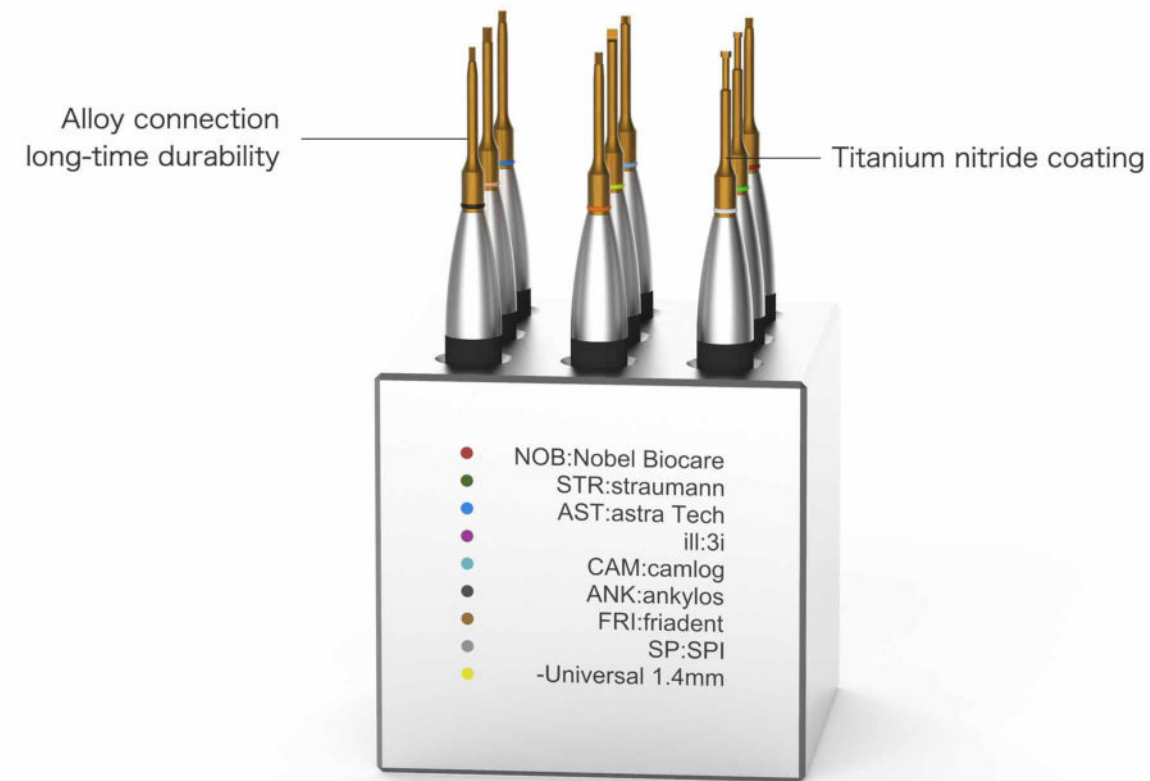

Clinic screwdriver

DO39-Y DO40-Y X8 pcs is a kit that applies to Osstem/Dentium/ Megagen / NOBLE/ ITI/ ICX/ 3I/ Ankylos/ Astra /Zimmer etc .M6 implant screw driver is made of medical class alloy , balancing design is to scatter bite stress to all surfaces ,which ensures long life time.

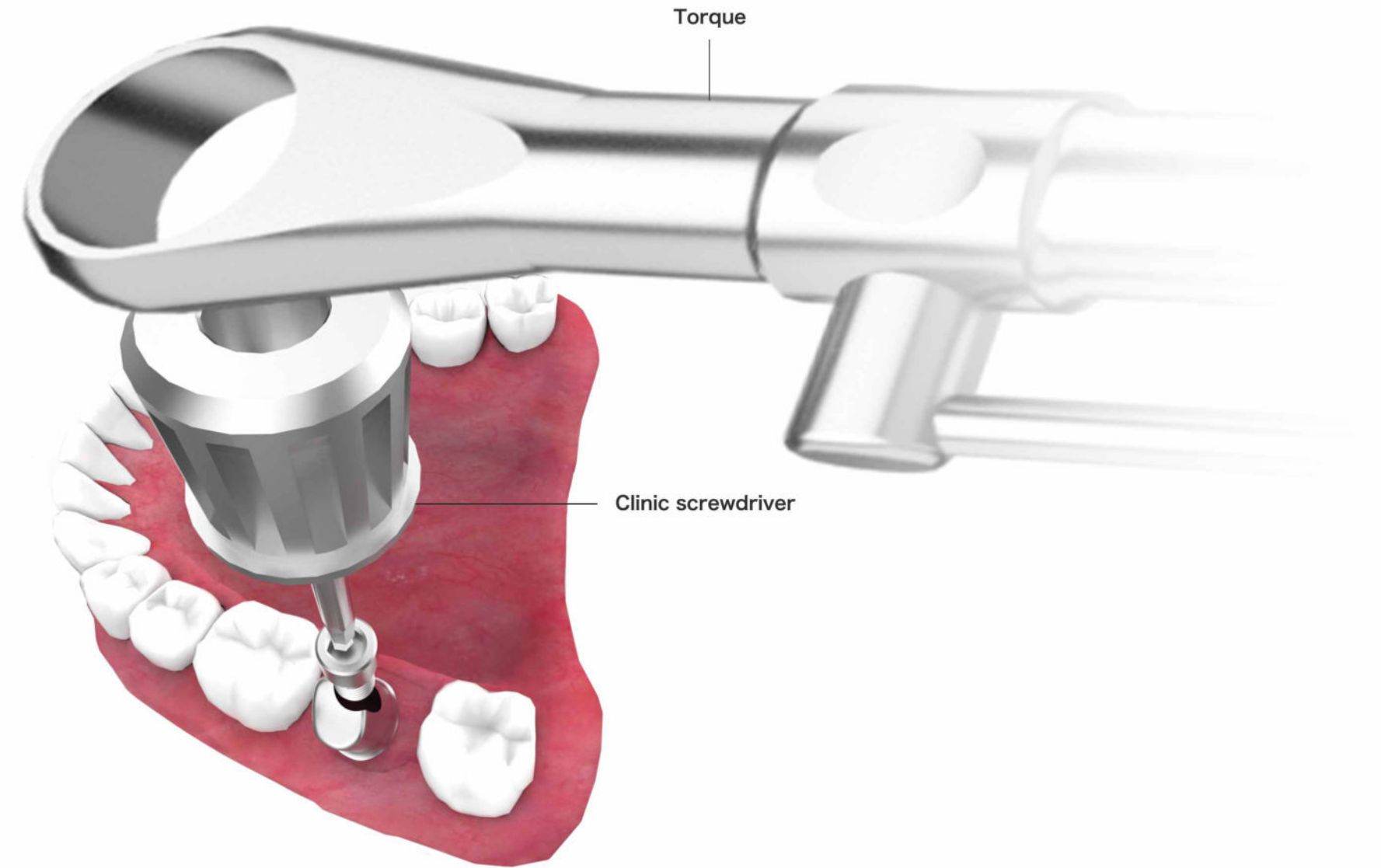
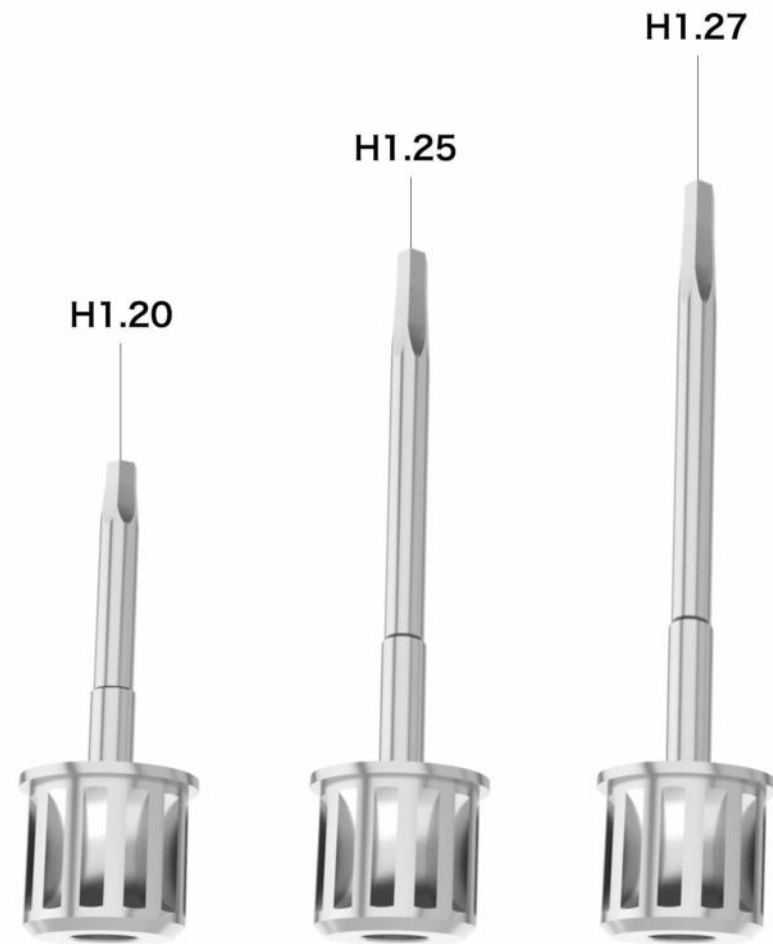

Hand-held grinder kit

- ✓Complete system ✓Double anti-rotation
- ✓Efficient and time-saving ✓Safe for hands

Hand-held grinder kit, covering 70+ systems for general grinding requirements. The hand-held grinder is commonly used for clamping/grinding/polishing of BASE/customized abutments/solid abutments. Double anti-rotation for stable milling, efficient and time-saving, safe for hands.

70+ Common system

220+ Model

50+ brand



Meet the needs of conventional grinding use



Double anti-rotation Lossless interface
 The grinding is stable and does not loosen Industrial-grade clamping structure

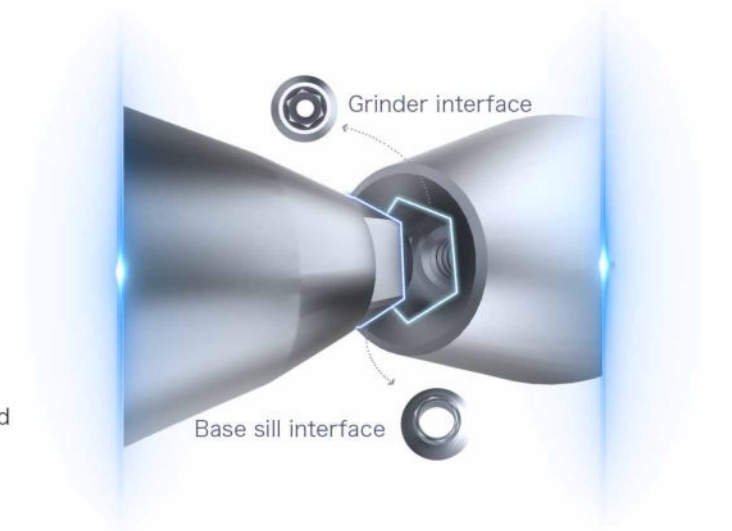

Compatibility list for hand-held grinder

Full systems

Handheld grinder sleeve covering 70+ systems for routine grinding needs.



产品编码	激光编码标识	型号	型号简称	编码	产品编码	激光编码标识	型号	型号简称	编码	产品编码	激光编码标识	型号	型号简称	编码				
DB002	1	Osstem(TS/GS)-M	OSS(GS)-M	2	DB012	7	Nobel BioCare (Replace) -WP	NOB(Rep)-W	012	DB038	20	Bicon-2.0	Bicon-2.0	038				
		Bioconcept- (BV) -M	Bct(BV)-M	167			ITI Straumann (Tissue Level) -RN	ITI(TL)-R	015			DB039	21	Bicon-2.5	Bicon-2.5	039		
		CSM-M	CSM-M	221			Dentium(SimpleLine II)-R	Den(Sim-II)-R	078			DB040	22	Bicon-3.0	Bicon-3.0	040		
		ZENOIS-M	ZENOIS-M	219			Bioconcept (BC-Tissue Level)-RN	Bct(BC)TL-RN	174			DB041	23	Astra (Osseo Speed-TX) -3.0	Ast(TX)-M	041		
		SNUC-M	SNUC-M	165			trausim (TL) -RP	Tra(TL)-R	190					ZIMMER (Azure) -3.0	Zim(Azr)-3.0	182		
		Anker- (SB-I/SB-II/SB-III) -N	Ank(SB)-N	80			ITI Straumann (Tissue Level) -WN	ITI(TL)-W	016					Cortex (Classix Conical) -3.0	Cortex(CC)3.0	193		
Osstem(TS/GS)-R	OSS(GS)-R	1	Bioconcept (BC-Tissue Level)-WN	Bct(BC) -TL-WN	175	Dio(UFII)-3.0	DIO(UF)-M	032UF										
DB003	2	Dentium (Super line)-R	Den(SPL)-R	3	DB016	9	trausim (TL) -WP	Tra(TL)-WP	191	DB042	24	Megagen Mlni	Meg(Mini)-M	089				
		Dio(UFII)-R/W	DIO(UF)-R	033UF			ITI Straumann (Bone level)-NC	ITI(BL)-M	017			Astra (Osseo Speed-TX) -3.5/4.0	Ast(TX)-R	042				
		NeoBiotech (IS) -R	Neo(IS)-R	101			Bioconcept- (BC) -Bone Level-NC	Bct(BC)BL-NC	176			ZIMMER (Azure) -3.5/4.0	Zim(Azr)-3.5	183				
		Megagen(Anyone)-R	Meg(AO)-R	090			CANSUN-M	Cansun-M	185			Cortex (Classix Conical) -3.5/4.0	Cortex(CC)3.5	194				
		SG(SST/STT/SRT)-R	SG-R	135			trausim (BL) -NC	Tra(BL)-NC	187			Astra (Osseo Speed-TX) -4.5/5.0	Ast(TX)-W	043				
		Dentis-R	Dts(SQ)-R	063			ITI Straumann (Bone level) -RC	ITI(BL)-R	018			ZIMMER (Azure) -4.5/5.0	Zim Az-4.5	184				
		INNO/CWM	INNO/CWM	211			Bioconcept- (BC) -Bone Level-RC	Bct(BC)BL-R	177			Cortex (Classix Conical) -4.5/5.0	Cortex(cc)4.5	195				
		CSM-R	CSM-R	212			CANSUN-R	Cansun-R	186			DB045	26	SIC-P3.3	SIC-M	044		
		ZENOIS-R	ZENOIS-R	220			trausim (BL) -RC	Tra(BL)-RC	188					SIC-P4.2	SIC-R	045		
		IBS-R	IBS-R	201			DB020	12	Nobel BioCare (Active) -NP			NOB(Act)-NP	020	DB047	27	ICX-4.0	ICX-4.0	047
		Bioconcept- (BV) -R	Bct(BV)-R	168					Dental Master(DM)-NP			DM-NP	198	DB048	28	Megagen(EZ PIUS)-M	Meg(EZ)-M	048
		SNUC-R	SNUC-R	166			DB021	13	Nobel BioCare (Active) -RP			NOB(Act)-RP	021	DB049	29	Megagen(EZ PIUS)-R/W	Meg(EZ)-R/W	049
Anker- (SB-I/SB-II/SB-III) -R	Ank(SB)-R	081	Dental Master(DM)-RP	DM-RP	199	DB050			30	Anthogyr (REG/PX) -R	Ant-R	050						
T Plus-R	T Plus-R	192	DB007	3	MIS(Seven)-NP	MIS (Sev)-M	007	DB051	21	Ankylos (C) -R	Ank-R	051						
DB008	4	MIS(Seven)-RP			MIS (Sev)-R	008	DB026	14	Zimmer(Tapered Screw-Vent)-R4.5	Zim(TSV)-R	026	DB053	32	Xive(xive-s plus)-3.4	XIVE-3.4	053		
		Cortex (Dynamix)			Cortex(Dyn)	133			MIS(Seven)-W	MIS(Sev)-W	009	Xive(xive-s plus)-3.8	XIVE-3.8	054				
		Alpha-Bio(SPI)-R			Alp(SPI)-R	099			Biohorizons-4.5	Bhr4.5	140	Xive(xive-s plus)-4.5-5	XIVE-4.5	055				
		Zimmer(Tapered Screw-Vent)-M3.5			Zim(TSV)-M	025			Implant direct legacy-4.5	IDL-4.5	179	Xive(xive-s plus)-5.5	XIVE-5.5	056				
		AB-R			AB-R	128			Ratio-L/WP	Ratio-W	206	Zimmer(Tapered Screw-Vent)-W5.7	Zim(TSV)-W	027	DB088	34	Megagen(AnyRidge)	Meg(AR)-R
		Biohorizons-3.5	Bhz-3.5	139	Implant direct legacy-5.7	IDL-5.7			180	Biohorizons-5.7	Bhr-5.7	141	DB131	35	B&B-R	B&B-R	131	
Adin-Touareg-OS/S	Adin-R	158	DB028	16	Biomet 3i (Certain) -3.25/3.4	3i(Cet)-M	028	DB147	36	C tech(EL)	C Tech(EL)	134						
Implant direct legacy-3.5	IDL-3.5	178			Biomet 3i (Certain) -4.0	3i(Cet)-R	029	DB159	37	ZUGA-3.5	ZUGA-3.5	147						
Ratio-S-(RP)	Ratio-RP	164	DB030	17	Biomet 3i (Certain) -5.0	3i(Cet)-W	030	DB163	38	Adin(CloseFit)-UNP	Adin-UNP	159						
DENTIN-R	DENTIN-R	157			DB197	39	Neoss-R	Neoss-R	163									
DB010	5	Nobel BioCare (Replace) -NP	NOB(Rep)-M	010	DB032	18	DIO(SM Torx)-N	DIO(SM)-M	032	DB197	39	NEODENT (GM)	NDT(GM)	197				
DB011	6	Nobel BioCare (Replace) -RP	NOB(Rep)-R	011	DB033	19	DIO(SM Torx)-R/W	DIO(SM)-R	033									

M6-Hand-held grinder

Make it easy to carry the small abutment

Hand-held grinder --- solving the problem of technicians need to hold the abutment. The hand-held grinding abutment fixtures design with subsection, that can hold different system abutment and pre-milled blank. M6 hand-held grinder has user-friendly design to increase comfortable and relieve hand fatigue. Reasonable friction design ,it is not easy to loose during work .

- Flip-top individual packaging
- Ergonomic design
- anti-slip handle
- safe and no hot for hand





Innovative digital equipment



Mill T4 Pro

✓ simultaneous machining ✓ Link-less milling with reverse jig

Simultaneous processing solution for titanium premilled abutment

- Precise milling
- simultaneous machining
- regular and reverse jig are available
- no need second scanning
- save time and simplify workflow

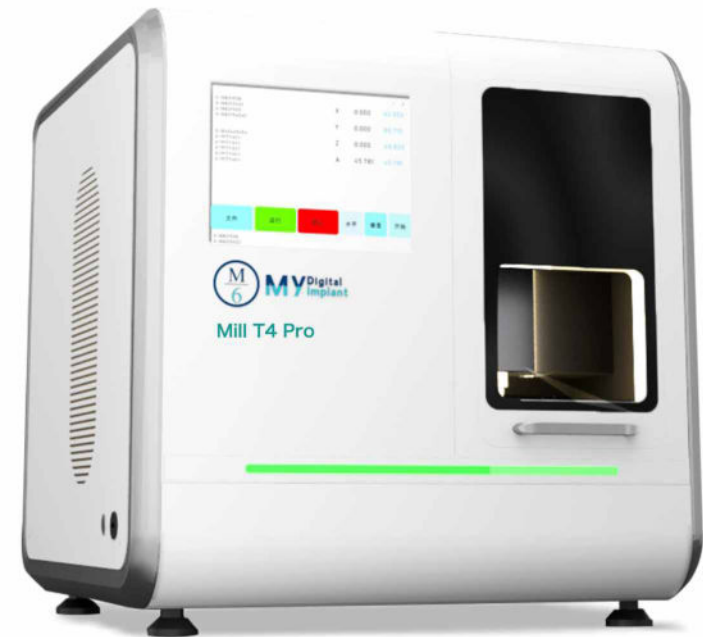

Simultaneous machining solution

1. scanning data



2. simultaneous design help you to make model, custom abutment crown



3. delivery the mould at the same time



could be machined:



Mill T4 Pro X

Solid abutment digital solution

- High precision
- High efficiency
- Experienced R&D team
- Professional after-sales service

Product Introduction

Mill T4 Pro X perfect milling vertically, solve the problem of solid abutment recessing and shoulder grinding out of place. 16 pieces in one clamping, reducing the assembly process. 10-15min milling time per unit. Industrial grade 4 axis metal milling system, high quality and high precision, high efficiency.



Perfect Milling Vertically



Clamp 16 pieces at a time



Mill T5 Pro

Our Mill makes dental lab more efficiently

T5 Pro is a professional CNC control 5 axis dental milling machine with high stability and high efficiency, absolute precision $\pm 5\mu\text{m}$, repeat position precision $2\mu\text{m}$, high rigidity + high precision + high speed 5 axis travel + industry grade controller + industry bur holder to change bur + big power spindle + disk/block/premilled blank holder.

Millable products: custom locator, custom MUA, custom abutment, bar and bridge

Millable material: PEEK discs, titanium disc, titanium premilled abutment

