

Solar Inverter Cover



Model:MC2-60(40)5530

Dimension:60(40)x55x30cm

Weight:7.3kg

Packing:50pcs/pallet

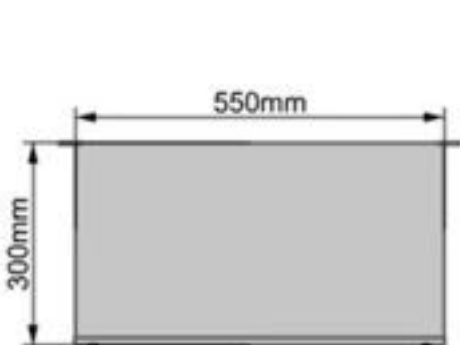

Top view

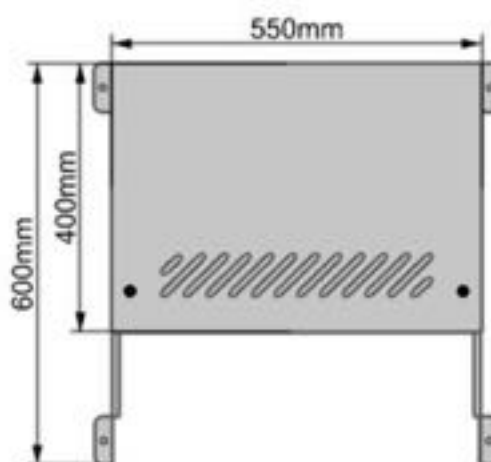

Front view

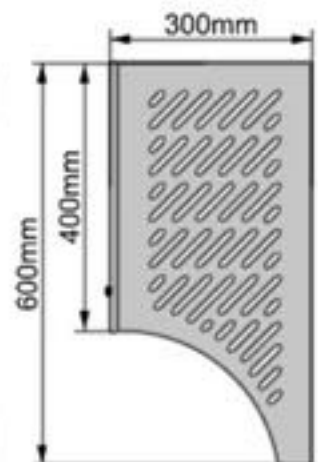

Right view

Solar Inverter Cover



Model:MC2-60(40)6530

Dimension:60(40)x65x30cm

Weight:8.7kg

Packing:50pcs/pallet

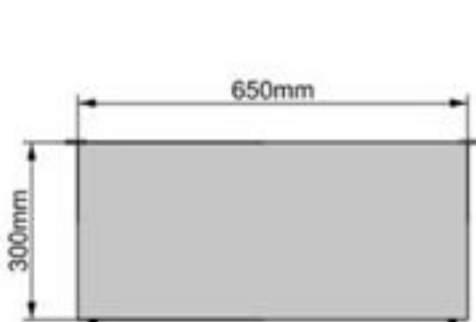

Top view

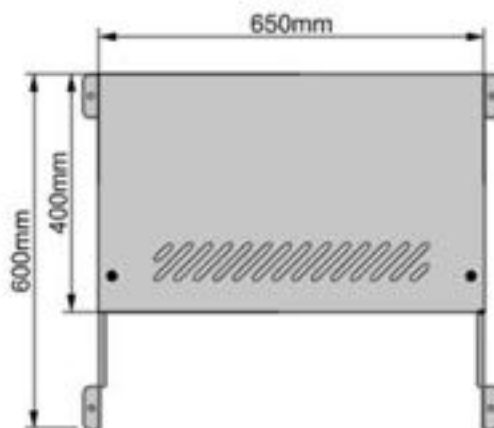

Front view

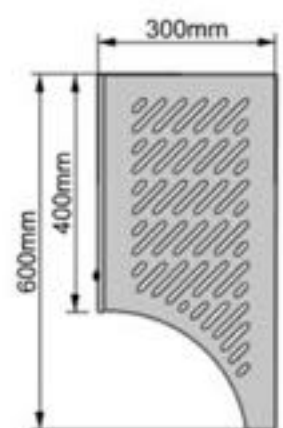

Right view

Solar Battery Cover



Model:MC2-60(40)7530

Dimension:60(40)x75x30cm

Weight:9.8kg

Packing:50pcs/pallet

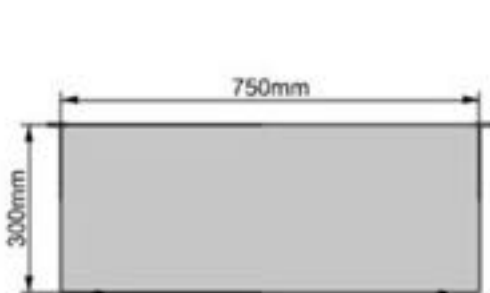

Top view

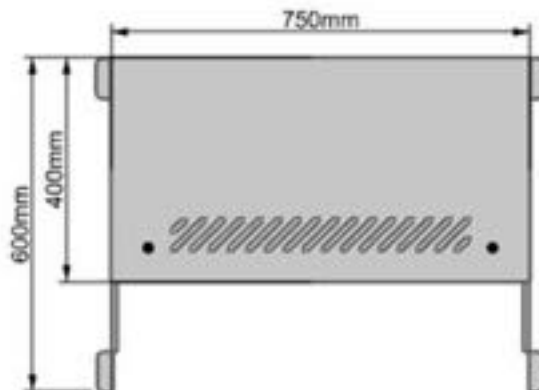

Front view

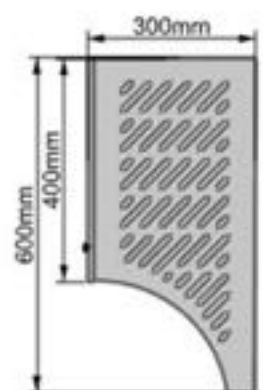

Right view

EV Charger Cover



Model:MC3-504029

Dimension:50x40x29cm

Weight:7.2kg

Packing:60pcs/pallet

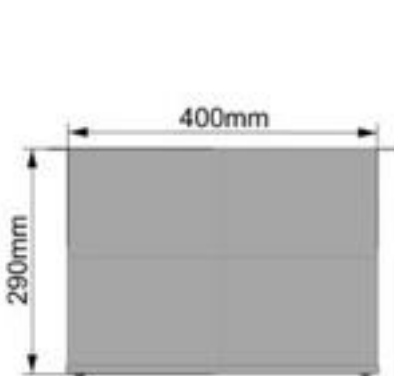

Top view

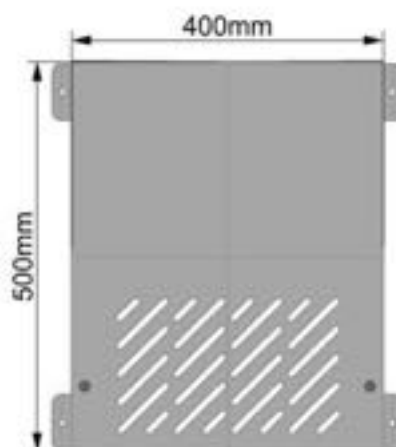

Front view

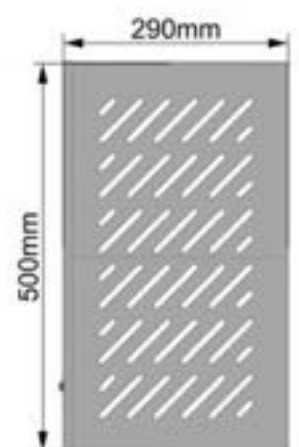

Right view

Solar Inverter Cover



Model:MC3-655529

Dimension:65x55x29cm

Weight:9.8kg

Packing:50pcs/pallet



Top view

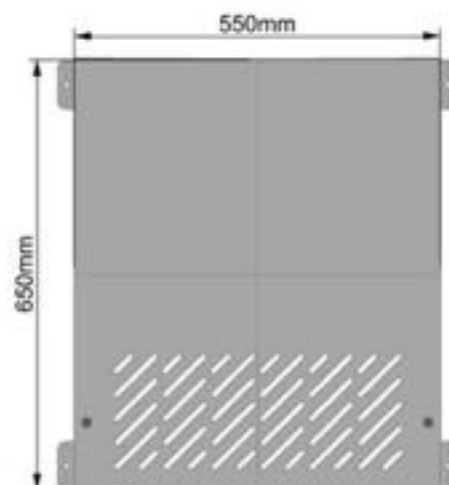

Front view

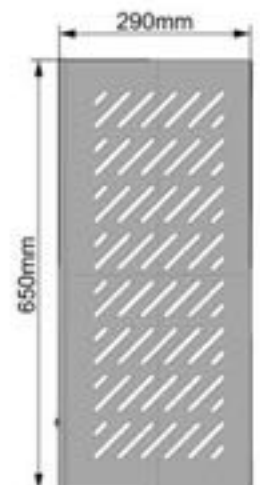

Right view

Solar Inverter Cover



Model:MC3-756532

Dimension:75x65x32cm

Weight:12.1kg

Packing:50pcs/pallet

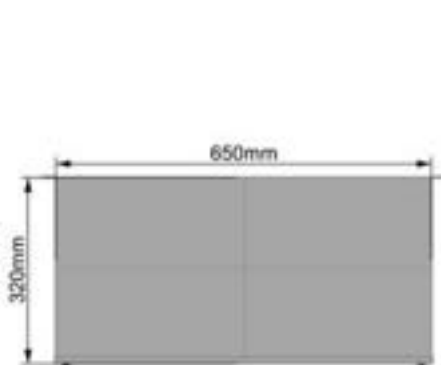

Top view

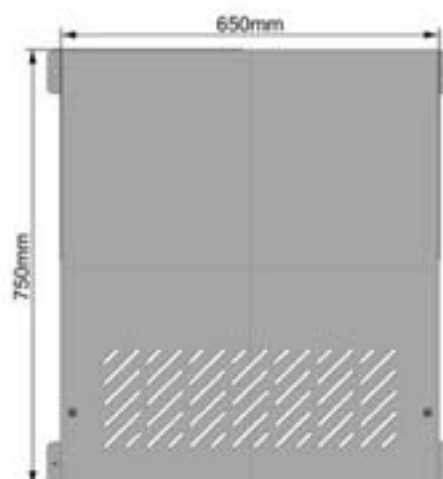

Front view

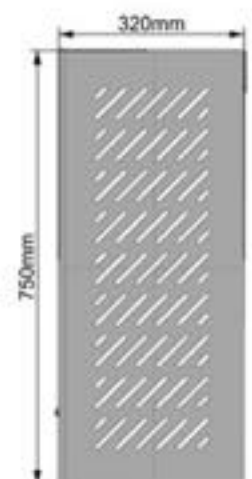

Right view

Solar Battery Cover



Model:MC3-1209042

Dimension:120x90x42cm

Weight:29kg

Packing:25pcs/pallet

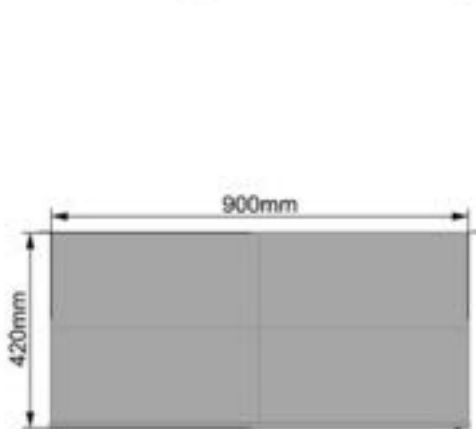

Top view

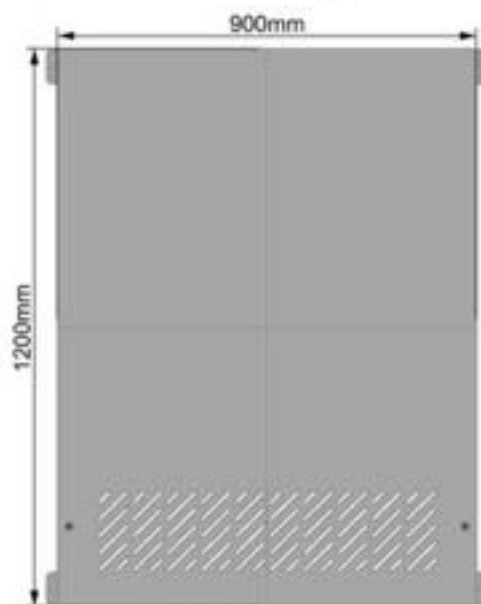

Front view

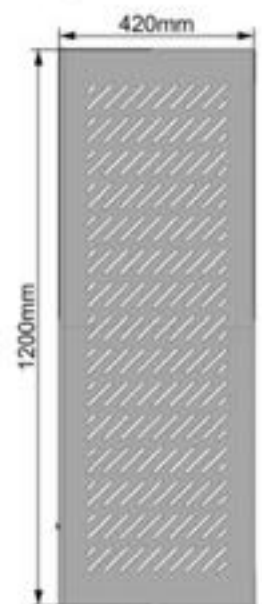

Right view

Solar Battery Cover



Model:MC3-1609042

Dimension:160x90x42cm

Weight:39kg

Packing:25pcs/pallet

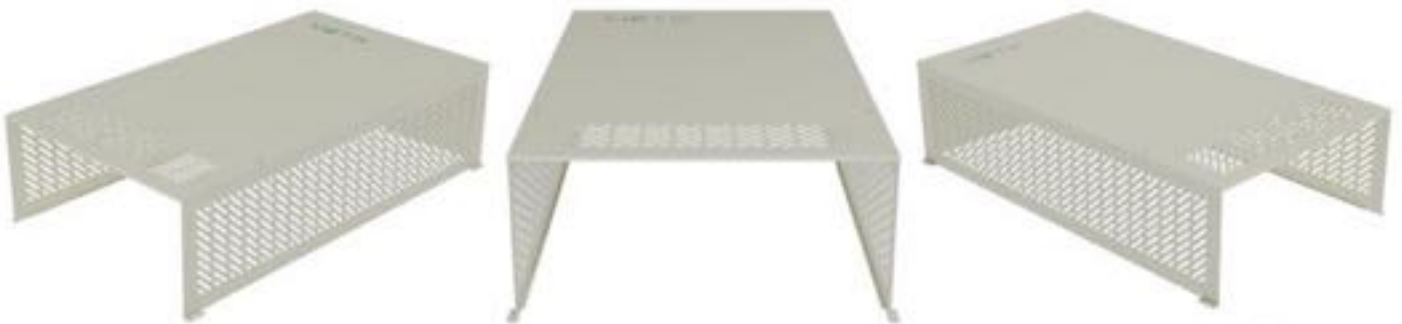

Top view

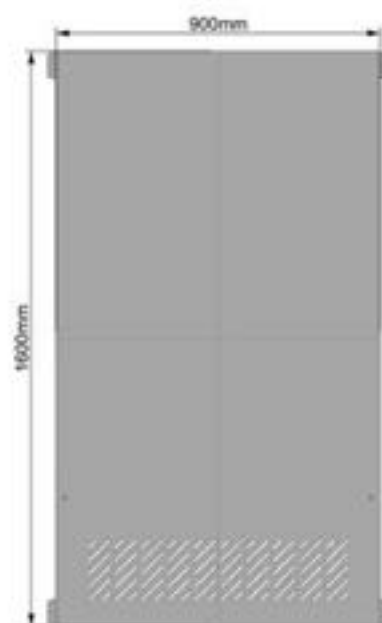

Front view

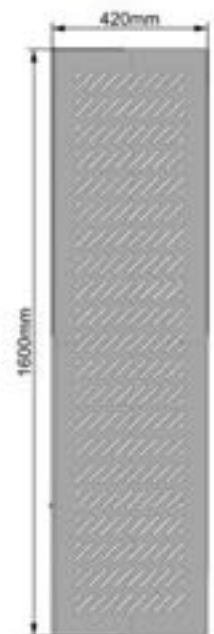

Right view